



# SLV NUMINOS®

---

Ein Down- und Spotlightsystem.  
Tausend Möglichkeiten.

# IMMER AKTUELL!

---

**Klicken Sie im Blätterkatalog auf die Artikelnummer und gelangen Sie so direkt zum gewünschten Produkt in unserem Online-Shop mit den aktuellen Informationen und Preisen!**



## KS LICHT und SLV : seit 30 Jahren starke Partner in Sachen Licht

### ABHOLZENTRUM IN ESSEN

Seit 30 Jahren ergänzt KS Licht- und Elektrotechnik GmbH die Produkte und Leistungen von SLV mit einer Vielzahl von Serviceleistungen. Wir unterhalten für Sie ein Abholzentrum für SLV Produkte mitten im Herzen des Ruhrgebiets, in dem Sie die bei uns bestellte Ware kurzfristig abholen können.

### SLV LEUCHTEN LIVE ERLEBEN

Auf mehr als 300 m<sup>2</sup> Ausstellungsfläche präsentieren wir Ihnen eine große Auswahl von SLV Leuchten. Hier beraten Sie unsere fachlich geschulten Berater und Lichtplaner persönlich. Gleichzeitig können Sie unsere Ausstellung nutzen, um Ihren Kunden unsere Leuchten in Funktion und Wirkung zu präsentieren. Überzeugen Sie sich von der Qualität unserer Außenleuchten in der Outdoor-Ausstellung.

### KOSTENLOSE LICHTPLANUNG

Wir entwickeln mit Ihnen und nach Ihren Bedürfnissen praxisorientierte Lichtlösungen. Ob für Geschäftsräume, Verkaufsräume oder privates Ambiente: Unsere Lichtplaner haben immer die passenden Konzepte für eine bedarfsorientierte und energetisch sinnvolle Lösung parat. Gerne berechnen wir für Sie die Amortisationszeit Ihrer neuen, energiesparenden LED-Beleuchtung.

### KS MULTI-BRAND LEUCHTEN ONLINESHOP

In unserem Onlineshop unter [www.KS-Licht.de](http://www.KS-Licht.de) finden Sie:

- Aktuelle Sonderangebote und Neuheiten
- Onlineprüfung der Warenverfügbarkeit
- Schnellbestellformular
- Alle Kataloge zum Downloaden oder als Blätterkatalog mit Produktlinks

**KS Licht- u. Elektrotechnik GmbH**  
**Manderscheidtstr. 8c**  
**45141 Essen**

Tel.: +49 (0)201-89924-0  
Fax: +49 (0)201-89924-124

Onlineshop: [www.KS-Licht.de](http://www.KS-Licht.de)  
Internet: [www.KS-Germany.com](http://www.KS-Germany.com)  
Email: [Verkauf@KS-Germany.com](mailto:Verkauf@KS-Germany.com)

**Besuchen Sie uns vor Ort oder rufen Sie uns an:**  
Montag - Donnerstag durchgehend von 08.00 Uhr bis 16.30 Uhr  
Freitag durchgehend von 08.00 Uhr bis 15.00 Uhr

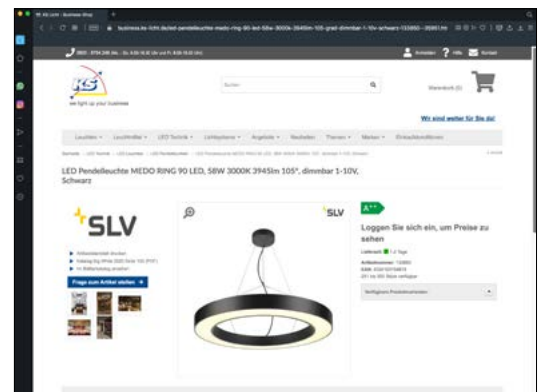

Scannen Sie den Link zu unserem Schnellbestellformular und erhalten Sie aktuelle Informationen über die Warenverfügbarkeit!



[www.ks-licht.de/schnellbestellformular](http://www.ks-licht.de/schnellbestellformular)







**SLV NUMINOS®**  
DOWN- UND  
SPOTLIGHTS

---

Das SLV NUMINOS® Leuchtensystem bietet konstante Lichteigenschaften und modernes Design über alle Anwendungen hinweg. Lassen Sie sich inspirieren.





FÜR JEDEN FALL  
DIE PASSENDE  
LICHTLÖSUNG.



# SLV NUMINOS®

Ein Leuchtensystem – Tausend Möglichkeiten.

Das frei konfigurierbare Leuchtensystem,  
das jedes Ambiente ins beste Licht rückt.

Kein Projekt ist wie das andere. Aber viele Projekte verlangen ein einheitliches Licht- und Designkonzept. SLV NUMINOS® ist ein perfekt aufeinander abgestimmtes Leuchtensystem, das Funktion, Design und Technik in Einklang bringt. Für Planer und Macher. Für jede Anforderung. Für maximale Vielfalt bei minimalem Aufwand.

NUMINOS®

HOCHLEISTUNGS LED MODUL MIT  
BRILLANTER FARBWIEDERGABE



BREITE AUSWAHL AN DOWNLIGHTS  
UND SPOTS FÜR EIN HARMONISCHES  
DESIGNKONZEPT.



SLV NUMINOS®



# MEHR FREIHEIT.

Mit System.

Was Sie auch vorhaben – das SLV NUMINOS® Leuchtensystem schafft Raum für Ideen.



Das SLV NUMINOS® Leuchtensystem bietet konstante Lichteigenschaften und modernes Design über alle Anwendungen hinweg:

- für Büroräume
- Shops & Boutiquen
- Hotellerie & Gastronomie
- Zuhause
- und vieles mehr

Vom Hotel übers Büro bis hin zu gewerblichen oder privaten Räumen. Von der Anwendung über die Technik bis zum Design im Detail: Gut, dass sich die modularen Down- und Spotlights genauso konfigurieren lassen, wie es die Planung oder Raumbedingungen erfordern. Und je facettenreicher Ihr Projekt ist, desto mehr profitieren Sie vom SLV NUMINOS® Leuchtensystem.

Licht inszenieren,  
ohne zu dominieren.



SLV NUMINOS®  
GIMBLE M, DL  
Art.-Nr.  
1005945  
SLV NUMINOS®  
Move S, DL  
Art.-Nr.  
1005340





Highlights,  
die nach unten  
strahlen.



SLV NUMINOS®  
XL, CL  
Art.-Nr.  
1005767

Frei für alle  
Dimensionen.



SLV NUMINOS®  
Zoom M, 3Ph.  
Art.-Nr.  
1006116

Perfekt zum  
Pendeln, in der  
Höhe variabel.



SLV NUMINOS®  
XL, PD  
Art.-Nr.  
1005783

EINZIGARTIGE VIELFALT,  
GEMEINSAME HIGHLIGHTS.

Wählen Sie zwischen:

- Downlight oder Spotlight
- Größen und Durchmessern
- Gehäusefarben (Schwarz/Weiß)
- Reflektorvarianten
- Schwenkbaren und starren Versionen
- Leistungsklassen

Die verschiedenen Varianten verfügen über:

- Hochleistungs LED Modul mit den Lichtfarben 2700K/3000K/4000K
- Farbqualität CRI>90
- Blendungsbewertung UGR mind. <22

# EIN LEUCHTENSYSTEM.

Durchdacht bis ins Detail.

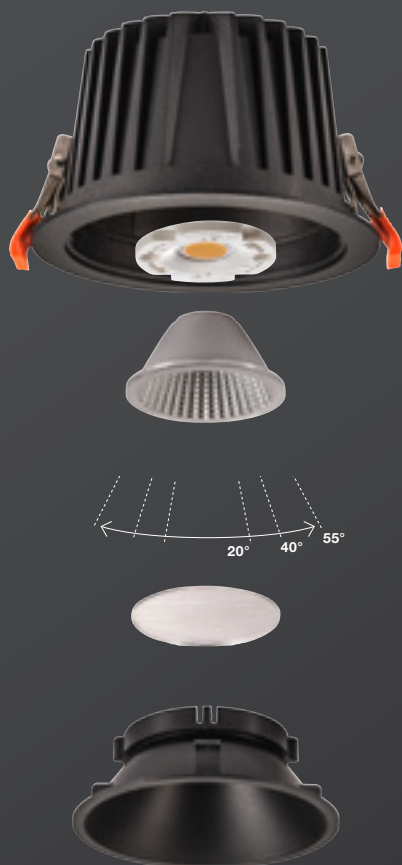

## DOWNLIGHTS

- In sieben Varianten (68-75mm bis 176-186mm) mit Hochleistungs-LED-Modul in drei Lichtfarben (2700K, 3000K, 4000K) und Blendungsbewertungen (UGR 16, 19, 22) erhältlich.
- Wählbare Reflektoren mit Halbstreuwinkeln von 20°, 40° oder 55°.
- Verschiedene Effektfilter (gefrostet/prismatisch/elliptisch/Wabe) als Zubehör verfügbar.
- Dekoring als sichtbarer Abschluss in Weiß, Schwarz oder Chrom wählbar.

SLV NUMINOS® Downlights sind als starre oder schwenkbare Variante (4x fix und 3x dreh- und schwenkbar) erhältlich.



**XS** **S** **M** **L** **XL**

### Zubehör mit System:

Ihren optionalen Treiber (On/Off, Phasendimmung, DALI) und passende Diffusoren können Sie über die Farbkodierung ganz einfach hinzufügen.

**Treiber, Diffusoren und Reduzierringe für das SLV NUMINOS® Downlight System finden Sie auf den Seiten 48-51.**

Dank der breiten Auswahl an Modulen gibt es für jede Anforderung die passende Lösung. Fix konfiguriert. Schnell und sicher installiert.



## SPOTLIGHTS

- In drei Gehäusegrößen (65x155mm, 85x175mm, 100x203mm) mit Hochleistungs LED Modul in drei Lichtfarben (2700K, 3000K, 4000K) verfügbar.
- Durch den verbauten LED-Treiber (Phasendimmung, DALI) sind alle Spotlights für den direkten Anschluss an 230V Netzspannung geeignet.
- Wählbare Linsen mit Halbstreuwinkeln von 24°, 36° oder 60°.

SLV NUMINOS® Spotlights sind als schwenkbarer oder starrer Deckenspot, Pendelleuchte und als Spot für 3-Phasen Schienensysteme erhältlich.



### Easy to install.

Weil sich Effizienz immer auszahlt, sind SLV Leuchten leicht, schnell und sicher zu installieren. So bietet der Anschluss via Montageplatte, Schienensystem, Schnellkupplung, Federbügel oder mit farbkodierten Treibern für Downlights einen entscheidenden Vorteil: Sie sparen Zeit Aufwand und damit auch Kosten.

# EIN LEUCHTENSYSYSTEM.

## Für alle Fälle.

Für Erfolg unter allen Bedingungen braucht es Teamplayer, die mit individuellen Stärken glänzen. Entdecken Sie, für welche Einsätze sich SLV NUMINOS® Leuchten besonders gut eignen.



Objekte zu einem  
Hingucker machen.



SLV NUMINOS®  
GIMBLE XS, DL  
Art.-Nr.  
1005817

### Downlights.

Unauffällige, moderne und platzsparende Beleuchtung, die den Fokus auf Objekte oder den Raum lenkt: Die Downlights des SLV NUMINOS® Leuchtensystems sind in in gewerblichen und privaten Räumen variabel einsetzbar.



Für die elegante  
Ausleuchtung von  
Wohnbereichen.



SLV NUMINOS®  
GIMBLE XS, DL  
Art.-Nr.  
1005843



Für Eingangsbe-  
reiche, die Gäste  
willkommen heißen.

---



SLV NUMINOS®  
XS, DL  
Art.-Nr.  
1005520

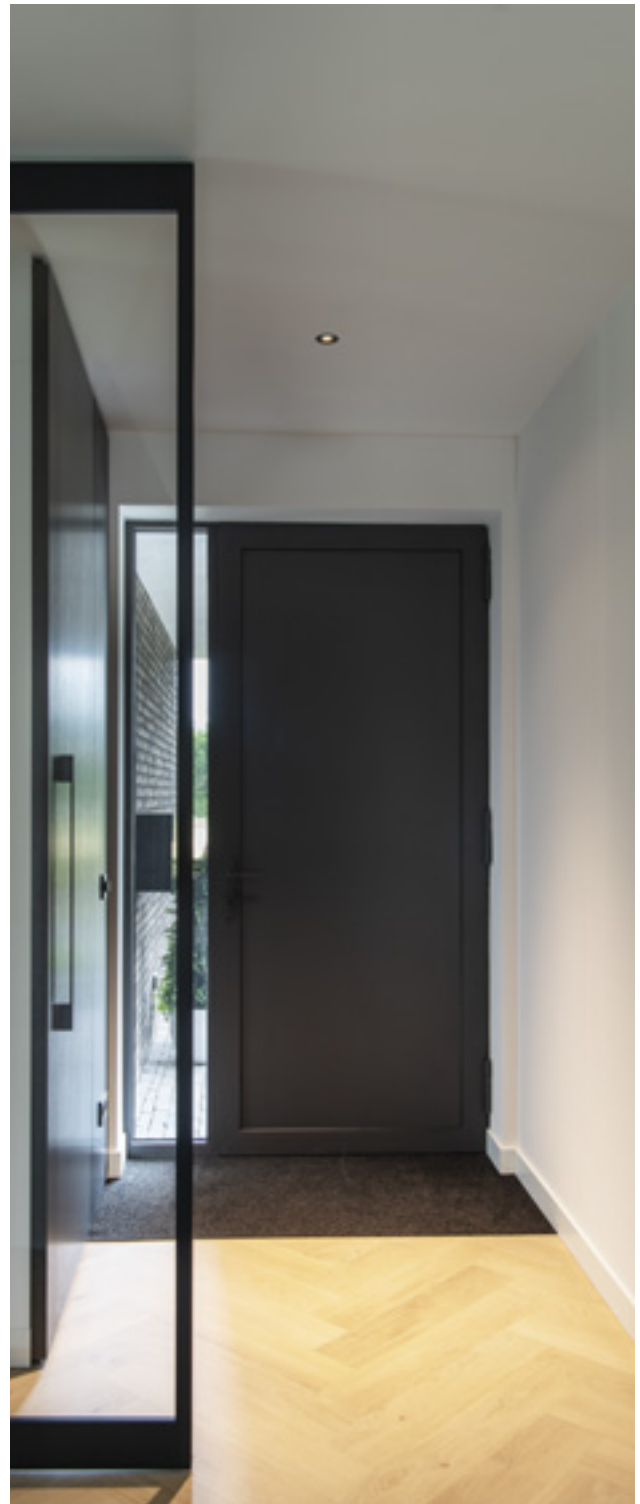

In Fluren den  
Weg weisen.

---



SLV NUMINOS®  
MOVE XS, DL  
Art.-Nr.  
1005584

**Beleuchtung individuell gestalten.**

Durch die große Auswahl an Reflektoren eignet sich das SLV NUMINOS® Leuchtensystem für die Akzentbeleuchtung wie auch zur Ausleuchtung von Produkten und Verkaufsflächen.

Um in Verkaufsräumen Akzente zu setzen.



SLV NUMINOS®  
GIMBLE M, DL  
Art.-Nr.  
1005953



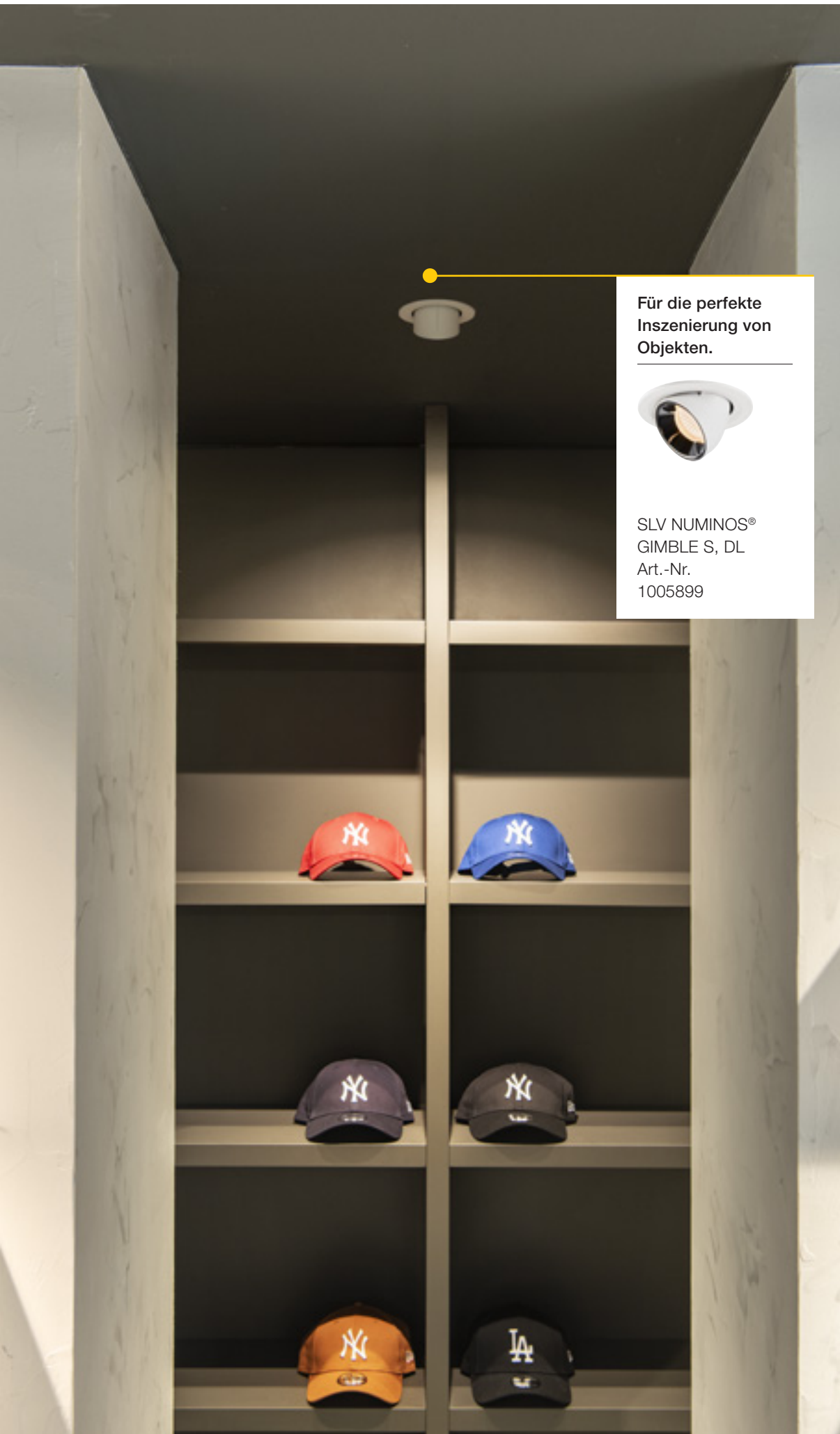

Für die perfekte  
Inszenierung von  
Objekten.



SLV NUMINOS®  
GIMBLE S, DL  
Art.-Nr.  
1005899



Für eine flexible  
Ausleuchtung in alle  
Raumdimensionen.



SLV NUMINOS®  
ZOOM M 3Ph.,  
PHASE  
Art.-Nr. 1006108

Produkte gekonnt  
in Szene setzen.



SLV NUMINOS®  
ZOOM M  
3Ph., DALI  
Art.-Nr. 1006119

### Spotlights.

In Shops und Boutiquen, aber auch in Restaurants, Bars, Museen, Studios, Praxen – in jedem Raum kommt es auf gekonnt gesetzte Akzente an. Spotlights sind sowohl für die Ausleuchtung größerer Flächen, als auch für die punktuelle Beleuchtung einsetzbar.







Um ein appetitanregendes Ambiente zu erschaffen.



SLV NUMINOS® M  
PD, PHASE  
Art.-Nr.  
1004247  
kombiniert  
mit Zierring  
Art.-Nr.  
1006168

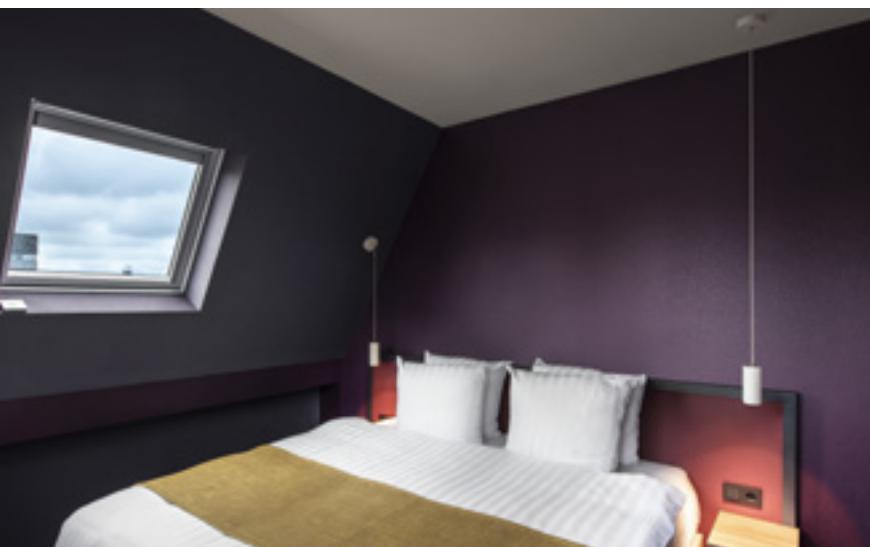

Für mehr Gemütlichkeit zu Hause.



SLV NUMINOS® S, PD, DALI  
Art.-Nr. 1004439  
kombiniert mit Zierring  
Art.-Nr. 1006167



# SYSTEMATISCH.

Zum Ziel.

Mit dem SLV NUMINOS® Online Konfigurator.

Nur drei Schritte und Sie sind am Ziel:

#### So einfach funktioniert der Konfigurator:

Die erste Frage lautet: Downlight oder Spotlight? Anschließend wählen Sie zwischen vorkonfigurierten und weiter anpassbaren Anwendungsszenarien oder der freien Konfiguration.

Falls Sie bei der Auswahl der Attribute noch unsicher sind, kein Problem: Zu jeder gewählten Konfiguration bieten wir Ihnen passende Erklärungen an.

Hier gelangen Sie zum SLV NUMINOS® Konfigurator:

[KS-Licht.de/NUMINOS-Konfiguratoren](https://www.ks-licht.de/NUMINOS-Konfiguratoren)

#### 1 TECHNISCHE KONFIGURATION



#### 2 OPTISCHE KONFIGURATION



#### 3 VISUELLE DARSTELLUNG & ABSCHLUSS

Hier und jetzt zum Ziel – konfigurieren Sie Ihre Leuchte mit dem BIG WHITE®.

**Stellen Sie Ihre Wunschleuchten auf den nächsten Seiten zusammen.**

Die folgenden Produktübersichten bringen Sie ebenso leicht zum Ziel: Blättern Sie zum gewünschten Leuchtentyp, folgen Sie den Spalten von links nach rechts und treffen Sie dabei Ihre individuelle Auswahl. Am Ende steht die passende Artikelnummer zur direkten Bestellung bereit.

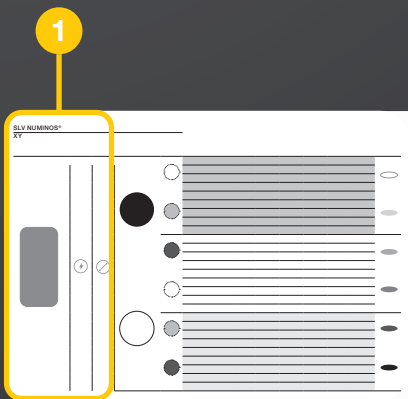

**STEP 1**

**SPOTLIGHT ODER DOWNLIGHT?**

Wählen Sie den passenden Leuchtentyp für Ihre Anforderung aus. Der Durchmesser (Downlights) bzw. die Gehäusegröße (Spotlights) sind dabei an die Systemleistung gekoppelt.

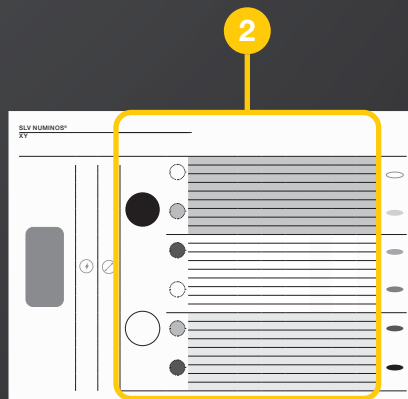

**STEP 2**

**TECHNISCHE KONFIGURATION & DESIGN AUSWÄHLEN**

Spalte für Spalte wählen Sie optische und technische Attribute wie Gehäuse- oder Dekoringfarben, die Farbtemperatur, Halbstreuwinkel und mehr aus.

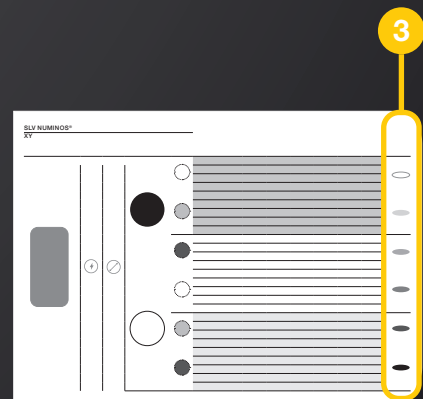

**STEP 3**

**PRODUKT**

Verschaffen Sie sich noch einen optischen Eindruck Ihrer fertig konfigurierten Leuchte, um sie gleich mit der passenden Artikelnummer zu bestellen.

**NOCH ETWAS UNKLAR?**



Scanne mich für ein Video, das anschaulich zeigt, wie einfach SLV NUMINOS® Leuchten zu konfigurieren sind.

Zusätzlich zu den bekannten Icons aus unserem Hauptkatalog BIG WHITE® finden Sie in diesem Kapitel folgende Icons:



**Blendungsbewertung**



**Farbtemperatur**



**Halbstreuwinkel**



**Lumen**



**Steuerung**

# SLV NUMINOS® XS



## DL

**XS**



### Produktangaben:

200mA

Leistungsaufnahme: 7W

Material: Aluminium / Polycarbonat (PC)

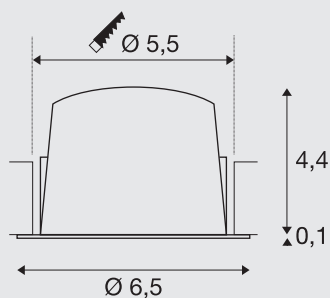

### Hinweis:

Niederspannungsstecker

Treiber exkl.

Blattfedern liegen dem Produkt bei und können ausgetauscht werden.

Passende Treiber, Diffusoren und Reduzierringe finden Sie auf den Seiten 50-53.



schwarz

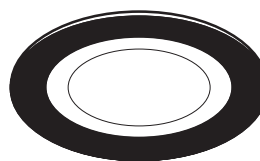

schwarz



weiß



chrom



schwarz

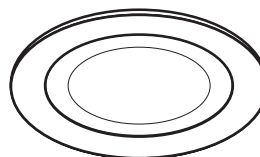

weiß



weiß





chrom





Blattfedern zur Installation  
in massiven Decken liegen bei.



				ART. NR.		
2700K	640lm	20°	16	<b>1005499</b>		
	620lm	40°	22	<b>1005502</b>		
	640lm	55°	25	<b>1005505</b>		
3000K	700lm	20°	16	<b>1005517</b>		
	670lm	40°	22	<b>1005520</b>		
	690lm	55°	25	<b>1005523</b>		
4000K	720lm	20°	16	<b>1005535</b>		
	700lm	40°	22	<b>1005538</b>		
	710lm	55°	25	<b>1005541</b>		
2700K	670lm	20°	16	<b>1005500</b>		
	650lm	40°	22	<b>1005503</b>		
	670lm	55°	25	<b>1005506</b>		
3000K	730lm	20°	16	<b>1005518</b>		
	700lm	40°	22	<b>1005521</b>		
	720lm	55°	25	<b>1005524</b>		
4000K	750lm	20°	16	<b>1005536</b>		
	730lm	40°	22	<b>1005539</b>		
	740lm	55°	25	<b>1005542</b>		
2700K	670lm	20°	16	<b>1005501</b>		
	650lm	40°	22	<b>1005504</b>		
	670lm	55°	25	<b>1005507</b>		
3000K	730lm	20°	16	<b>1005519</b>		
	700lm	40°	22	<b>1005522</b>		
	720lm	55°	25	<b>1005525</b>		
4000K	750lm	20°	16	<b>1005537</b>		
	730lm	40°	22	<b>1005540</b>		
	740lm	55°	25	<b>1005543</b>		
2700K	640lm	20°	16	<b>1005508</b>		
	620lm	40°	22	<b>1005511</b>		
	640lm	55°	25	<b>1005514</b>		
3000K	700lm	20°	16	<b>1005526</b>		
	670lm	40°	22	<b>1005529</b>		
	690lm	55°	25	<b>1005532</b>		
4000K	720lm	20°	16	<b>1005544</b>		
	700lm	40°	22	<b>1005547</b>		
	710lm	55°	25	<b>1005550</b>		
2700K	670lm	20°	16	<b>1005509</b>		
	650lm	40°	22	<b>1005512</b>		
	670lm	55°	25	<b>1005515</b>		
3000K	730lm	20°	16	<b>1005527</b>		
	700lm	40°	22	<b>1005530</b>		
	720lm	55°	25	<b>1005533</b>		
4000K	750lm	20°	16	<b>1005545</b>		
	730lm	40°	22	<b>1005548</b>		
	740lm	55°	25	<b>1005551</b>		
2700K	670lm	20°	16	<b>1005510</b>		
	650lm	40°	22	<b>1005513</b>		
	670lm	55°	25	<b>1005516</b>		
3000K	730lm	20°	16	<b>1005528</b>		
	700lm	40°	22	<b>1005531</b>		
	720lm	55°	25	<b>1005534</b>		
4000K	750lm	20°	16	<b>1005546</b>		
	730lm	40°	22	<b>1005549</b>		
	740lm	55°	25	<b>1005552</b>		

# SLV NUMINOS® S



## DL

S



### Produktangaben:

250mA

Leistungsaufnahme: 8,6W

Material: Aluminium / Polycarbonat (PC)

Einbaumaße: Ø: 6,8 cm T: 5,5 cm

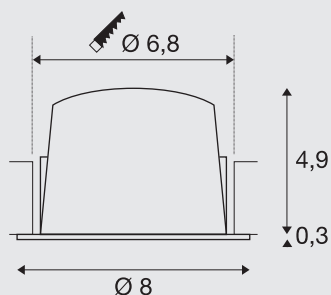

### Hinweis:

Niederspannungsstecker

Treiber exkl.

Blattfedern liegen dem Produkt bei und können ausgetauscht werden.

Passende Treiber, Diffusoren und Reduzierringe finden Sie auf den Seiten 50-53.



schwarz

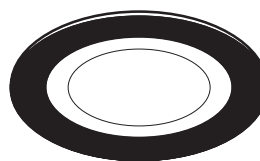

schwarz



weiß



chrom



schwarz

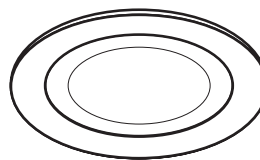

weiß



weiß



chrom



Blattfedern zur Installation  
in massiven Decken liegen bei.



				ART. NR.	
2700K	670lm	20°	19	<b>1003769</b>	
	670lm	40°	18,5	<b>1003772</b>	
	670lm	55°	22	<b>1003775</b>	
3000K	690lm	20°	19	<b>1003793</b>	
	690lm	40°	19	<b>1003796</b>	
	690lm	55°	22	<b>1003799</b>	
4000K	730lm	20°	19	<b>1003817</b>	
	730lm	40°	19	<b>1003820</b>	
	730lm	55°	22	<b>1003823</b>	
2700K	720lm	20°	18,5	<b>1003770</b>	
	720lm	40°	19	<b>1003773</b>	
	720lm	55°	22	<b>1003776</b>	
3000K	730lm	20°	19	<b>1003794</b>	
	730lm	40°	19	<b>1003797</b>	
	730lm	55°	22	<b>1003800</b>	
4000K	790lm	20°	19	<b>1003818</b>	
	790lm	40°	19	<b>1003821</b>	
	790lm	55°	22	<b>1003824</b>	
2700K	690lm	20°	19	<b>1003771</b>	
	690lm	40°	19	<b>1003774</b>	
	690lm	55°	22	<b>1003777</b>	
3000K	700lm	20°	19	<b>1003795</b>	
	700lm	40°	19	<b>1003798</b>	
	700lm	55°	19	<b>1003801</b>	
4000K	750lm	20°	19	<b>1003819</b>	
	750lm	40°	19	<b>1003822</b>	
	750lm	55°	22	<b>1003825</b>	
2700K	670lm	20°	19	<b>1003781</b>	
	670lm	40°	19	<b>1003784</b>	
	670lm	55°	22	<b>1003787</b>	
3000K	690lm	20°	19	<b>1003805</b>	
	690lm	40°	19	<b>1003808</b>	
	690lm	55°	22	<b>1003811</b>	
4000K	730lm	20°	19	<b>1003829</b>	
	730lm	40°	19	<b>1003832</b>	
	730lm	55°	22	<b>1003835</b>	
2700K	720lm	20°	18,5	<b>1003782</b>	
	720lm	40°	19	<b>1003785</b>	
	720lm	55°	22	<b>1003788</b>	
3000K	730lm	20°	19	<b>1003806</b>	
	730lm	40°	19	<b>1003809</b>	
	730lm	55°	22	<b>1003812</b>	
4000K	790lm	20°	19	<b>1003830</b>	
	790lm	40°	19	<b>1003833</b>	
	790lm	55°	22	<b>1003836</b>	
2700K	690lm	20°	19	<b>1003783</b>	
	690lm	40°	19	<b>1003786</b>	
	690lm	55°	22	<b>1003789</b>	
3000K	700lm	20°	19	<b>1003807</b>	
	700lm	40°	19	<b>1003810</b>	
	700lm	55°	22	<b>1003813</b>	
4000K	750lm	20°	19	<b>1003831</b>	
	750lm	40°	19	<b>1003834</b>	
	750lm	55°	22	<b>1003837</b>	

# SLV NUMINOS® M



## DL

M



### Produktangaben:

500mA

Leistungsaufnahme: 17,5W

Material: Aluminium / Polycarbonat (PC)

Einbaumaße: Ø: 9 cm T: 7,5 cm

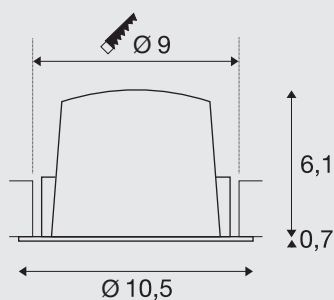

### Hinweis:

Niederspannungsstecker

Treiber exkl.

Blattfedern liegen dem Produkt bei und können ausgetauscht werden.

Passende Treiber, Diffusoren und Reduzierringe finden Sie auf den Seiten 50-53.



schwarz

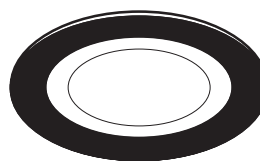

schwarz



weiß



chrom



schwarz

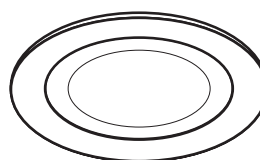

weiß



weiß



chrom





Blattfedern zur Installation  
in massiven Decken liegen bei.



				ART. NR.	
2700K	1460lm	20°	19	<b>1003841</b>	
	1460lm	40°	22	<b>1003844</b>	
	1460lm	55°	22	<b>1003847</b>	
3000K	1500lm	20°	19	<b>1003865</b>	
	1500lm	40°	22	<b>1003868</b>	
	1500lm	55°	22	<b>1003871</b>	
4000K	1600lm	20°	19	<b>1003889</b>	
	1600lm	40°	22	<b>1003892</b>	
	1600lm	55°	22	<b>1003895</b>	
2700K	1600lm	20°	22	<b>1003842</b>	
	1600lm	40°	19,4	<b>1003845</b>	
	1600lm	55°	22	<b>1003848</b>	
3000K	1600lm	20°	22	<b>1003866</b>	
	1600lm	40°	22	<b>1003869</b>	
	1600lm	55°	22	<b>1003872</b>	
4000K	1750lm	20°	22	<b>1003890</b>	
	1750lm	40°	22	<b>1003893</b>	
	1750lm	55°	22	<b>1003896</b>	
2700K	1550lm	20°	19	<b>1003843</b>	
	1550lm	40°	19	<b>1003846</b>	
	1550lm	55°	19	<b>1003849</b>	
3000K	1550lm	20°	19	<b>1003867</b>	
	1550lm	40°	19	<b>1003870</b>	
	1550lm	55°	19	<b>1003873</b>	
4000K	1660lm	20°	19	<b>1003891</b>	
	1660lm	40°	19	<b>1003894</b>	
	1660lm	55°	19	<b>1003897</b>	
2700K	1460lm	20°	19	<b>1003853</b>	
	1460lm	40°	22	<b>1003856</b>	
	1460lm	55°	22	<b>1003859</b>	
3000K	1500lm	20°	19	<b>1003877</b>	
	1500lm	40°	22	<b>1003880</b>	
	1500lm	55°	22	<b>1003883</b>	
4000K	1600lm	20°	19	<b>1003901</b>	
	1600lm	40°	22	<b>1003904</b>	
	1600lm	55°	22	<b>1003907</b>	
2700K	1600lm	20°	22	<b>1003854</b>	
	1600lm	40°	19	<b>1003857</b>	
	1600lm	55°	22	<b>1003860</b>	
3000K	1600lm	20°	22	<b>1003878</b>	
	1600lm	40°	22	<b>1003881</b>	
	1600lm	55°	22	<b>1003884</b>	
4000K	1750lm	20°	22	<b>1003902</b>	
	1750lm	40°	22	<b>1003905</b>	
	1750lm	55°	22	<b>1003908</b>	
2700K	1550lm	20°	19	<b>1003855</b>	
	1550lm	40°	19	<b>1003858</b>	
	1550lm	55°	19	<b>1003861</b>	
3000K	1550lm	20°	19	<b>1003879</b>	
	1550lm	40°	19	<b>1003882</b>	
	1550lm	55°	19	<b>1003885</b>	
4000K	1660lm	20°	19	<b>1003903</b>	
	1660lm	40°	19	<b>1003906</b>	
	1660lm	55°	19	<b>1003909</b>	

# SLV NUMINOS® L



## DL



### Produktangaben:

700mA

Leistungsaufnahme: 25,4W

Material: Aluminium / Polycarbonat (PC)

Einbaumaße: Ø: 11,7 cm T: 9 cm



IP 20 /  
IP 44

IK02

L80B50

10

LED

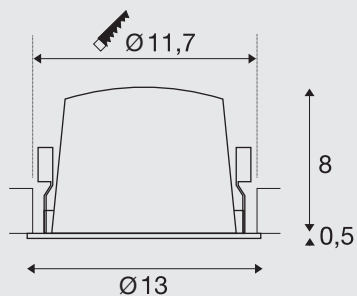

### Hinweis:

Niederspannungsstecker

Treiber exkl.

Passende Treiber, Diffusoren und Reduzierringe finden Sie auf den Seiten 50-53.



schwarz

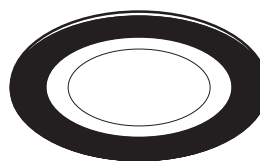

schwarz



weiß



chrom



schwarz

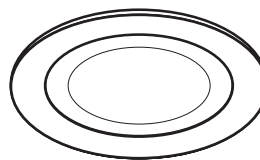

weiß



weiß



chrom



ART. NR.

2700K	2150lm	20°	22	<b>1003913</b>
	2150lm	40°	22	<b>1003916</b>
	2150lm	55°	22	<b>1003919</b>
3000K	2150lm	20°	22	<b>1003937</b>
	2150lm	40°	22	<b>1003940</b>
	2150lm	55°	25	<b>1003943</b>
4000K	2350lm	20°	22	<b>1003961</b>
	2350lm	40°	22	<b>1003964</b>
	2350lm	55°	25	<b>1003967</b>
2700K	2250lm	20°	19	<b>1003914</b>
	2250lm	40°	19	<b>1003917</b>
	2250lm	55°	22	<b>1003920</b>
3000K	2300lm	20°	19	<b>1003938</b>
	2300lm	40°	19	<b>1003941</b>
	2300lm	55°	20	<b>1003944</b>
4000K	2450lm	20°	19	<b>1003962</b>
	2450lm	40°	19	<b>1003965</b>
	2450lm	55°	22	<b>1003968</b>
2700K	2150lm	20°	19	<b>1003915</b>
	2150lm	40°	19	<b>1003918</b>
	2150lm	55°	19	<b>1003921</b>
3000K	2200lm	20°	19	<b>1003939</b>
	2200lm	40°	19	<b>1003942</b>
	2200lm	55°	19	<b>1003945</b>
4000K	2350lm	20°	19	<b>1003963</b>
	2350lm	40°	19	<b>1003966</b>
	2350lm	55°	19	<b>1003969</b>
2700K	2150lm	20°	22	<b>1003925</b>
	2150lm	40°	22	<b>1003928</b>
	2150lm	55°	22	<b>1003931</b>
3000K	2150lm	20°	22	<b>1003949</b>
	2150lm	40°	22	<b>1003952</b>
	2150lm	55°	25	<b>1003955</b>
4000K	2350lm	20°	22	<b>1003973</b>
	2350lm	40°	22	<b>1003976</b>
	2350lm	55°	25	<b>1003979</b>
2700K	2250lm	20°	19	<b>1003926</b>
	2250lm	40°	19	<b>1003929</b>
	2250lm	55°	22	<b>1003932</b>
3000K	2300lm	20°	19	<b>1003950</b>
	2300lm	40°	19	<b>1003953</b>
	2300lm	55°	22	<b>1003956</b>
4000K	2450lm	20°	19	<b>1003974</b>
	2450lm	40°	19	<b>1003977</b>
	2450lm	55°	22	<b>1003980</b>
2700K	2150lm	20°	19	<b>1003927</b>
	2150lm	40°	19	<b>1003930</b>
	2150lm	55°	19	<b>1003933</b>
3000K	2200lm	20°	19	<b>1003951</b>
	2200lm	40°	19	<b>1003954</b>
	2200lm	55°	19	<b>1003957</b>
4000K	2350lm	20°	19	<b>1003975</b>
	2350lm	40°	19	<b>1003978</b>
	2350lm	55°	19	<b>1003981</b>



# SLV NUMINOS® XL



## DL

### XL



#### Produktangaben:

1050mA

Leistungsaufnahme: 37,4W

Material: Aluminium / Polycarbonat (PC)

Einbaumaße: Ø: 14,5 cm T: 11,5 cm

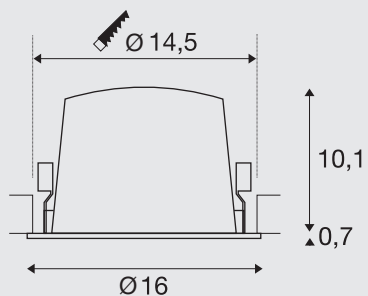

#### Hinweis:

Niederspannungsstecker

Treiber exkl.

Passende Treiber, Diffusoren und Reduzierringe finden Sie auf den Seiten 50-53.



schwarz

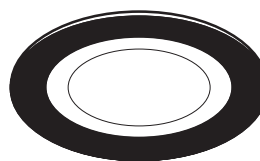

schwarz



weiß



chrom



schwarz

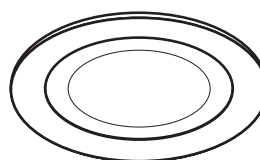

weiß



weiß



chrom





ART. NR.

2700K	3300lm	20°	22	<b>1003985</b>
	3300lm	40°	22	<b>1003988</b>
	3300lm	55°	22	<b>1003991</b>
3000K	3300lm	20°	22	<b>1004009</b>
	3300lm	40°	22	<b>1004012</b>
	3300lm	55°	22	<b>1004015</b>
4000K	3600lm	20°	22	<b>1004033</b>
	3600lm	40°	22	<b>1004036</b>
	3600lm	55°	25	<b>1004039</b>
2700K	3500lm	20°	19	<b>1003986</b>
	3500lm	40°	19	<b>1003989</b>
	3500lm	55°	19	<b>1003992</b>
3000K	3550lm	20°	19	<b>1004010</b>
	3550lm	40°	19	<b>1004013</b>
	3550lm	55°	19	<b>1004016</b>
4000K	3800lm	20°	19	<b>1004034</b>
	3800lm	40°	19	<b>1004037</b>
	3800lm	55°	19	<b>1004040</b>
2700K	3400lm	20°	19	<b>1003987</b>
	3400lm	40°	19	<b>1003990</b>
	3400lm	55°	19	<b>1003993</b>
3000K	3500lm	20°	19	<b>1004011</b>
	3500lm	40°	19	<b>1004014</b>
	3500lm	55°	19	<b>1004017</b>
4000K	3750lm	20°	19	<b>1004035</b>
	3750lm	40°	19	<b>1004038</b>
	3750lm	55°	19	<b>1004041</b>
2700K	3300lm	20°	22	<b>1003997</b>
	3300lm	40°	22	<b>1004000</b>
	3300lm	55°	22	<b>1004003</b>
3000K	3300lm	20°	22	<b>1004021</b>
	3300lm	40°	22	<b>1004024</b>
	3300lm	55°	22	<b>1004027</b>
4000K	3600lm	20°	22	<b>1004045</b>
	3600lm	40°	22	<b>1004048</b>
	3600lm	55°	25	<b>1004051</b>
2700K	3500lm	20°	19	<b>1003998</b>
	3500lm	40°	19	<b>1004001</b>
	3500lm	55°	19	<b>1004004</b>
3000K	3550lm	20°	19	<b>1004022</b>
	3550lm	40°	19	<b>1004025</b>
	3550lm	55°	19	<b>1004028</b>
4000K	3800lm	20°	19	<b>1004046</b>
	3800lm	40°	19	<b>1004049</b>
	3800lm	55°	19	<b>1004052</b>
2700K	3400lm	20°	19	<b>1003999</b>
	3400lm	40°	19	<b>1004002</b>
	3400lm	55°	19	<b>1004005</b>
3000K	3500lm	20°	19	<b>1004023</b>
	3500lm	40°	19	<b>1004026</b>
	3500lm	55°	19	<b>1004029</b>
4000K	3750lm	20°	19	<b>1004047</b>
	3750lm	40°	19	<b>1004050</b>
	3750lm	55°	19	<b>1004053</b>



# SLV NUMINOS® MOVE XS



## DL

### XS



#### Produktangaben:

200mA

Leistungsaufnahme: 7W

Material: Aluminium / Polycarbonat (PC)

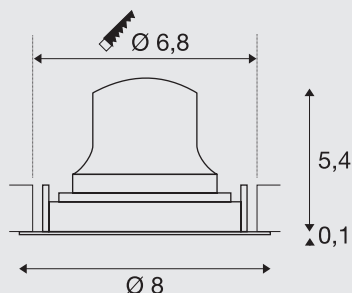

#### Hinweis:

Niederspannungsstecker  
Treiber exkl.

Passende Treiber, Diffusoren und Reduzierringe finden Sie auf den Seiten 50-53.



schwarz

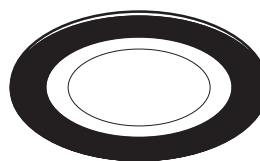

schwarz



weiß



chrom



schwarz

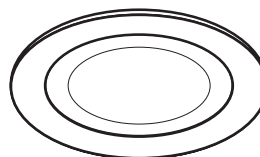

weiß



weiß



chrom



ART. NR.

2700K	640 lm	20°	16	<b>1005553</b>		
	620 lm	40°	22	<b>1005556</b>		
	640 lm	55°	25	<b>1005559</b>		
3000K	700 lm	20°	16	<b>1005571</b>		
	670 lm	40°	22	<b>1005574</b>		
	690 lm	55°	25	<b>1005577</b>		
4000K	720 lm	20°	16	<b>1005589</b>		
	700 lm	40°	22	<b>1005592</b>		
	710 lm	55°	25	<b>1005595</b>		
2700K	670 lm	20°	16	<b>1005554</b>		
	650 lm	40°	22	<b>1005557</b>		
	670 lm	55°	25	<b>1005560</b>		
3000K	730 lm	20°	16	<b>1005572</b>		
	700 lm	40°	22	<b>1005575</b>		
	720 lm	55°	25	<b>1005578</b>		
4000K	750 lm	20°	16	<b>1005590</b>		
	730 lm	40°	22	<b>1005593</b>		
	740 lm	55°	25	<b>1005596</b>		
2700K	670 lm	20°	16	<b>1005555</b>		
	650 lm	40°	22	<b>1005558</b>		
	670 lm	55°	25	<b>1005561</b>		
3000K	730 lm	20°	16	<b>1005573</b>		
	700 lm	40°	22	<b>1005576</b>		
	720 lm	55°	25	<b>1005579</b>		
4000K	750 lm	20°	16	<b>1005591</b>		
	730 lm	40°	22	<b>1005594</b>		
	740 lm	55°	25	<b>1005597</b>		
2700K	640 lm	20°	16	<b>1005562</b>		
	620 lm	40°	22	<b>1005565</b>		
	640 lm	55°	25	<b>1005568</b>		
3000K	700 lm	20°	16	<b>1005580</b>		
	670 lm	40°	22	<b>1005583</b>		
	690 lm	55°	25	<b>1005586</b>		
4000K	720 lm	20°	16	<b>1005598</b>		
	700 lm	40°	22	<b>1005603</b>		
	710 lm	55°	25	<b>1005606</b>		
2700K	670 lm	20°	16	<b>1005563</b>		
	650 lm	40°	22	<b>1005566</b>		
	670 lm	55°	25	<b>1005569</b>		
3000K	730 lm	20°	16	<b>1005581</b>		
	700 lm	40°	22	<b>1005584</b>		
	720 lm	55°	25	<b>1005587</b>		
4000K	750 lm	20°	16	<b>1005599</b>		
	730 lm	40°	22	<b>1005604</b>		
	740 lm	55°	25	<b>1005607</b>		
2700K	670 lm	20°	16	<b>1005564</b>		
	650 lm	40°	22	<b>1005567</b>		
	670 lm	55°	25	<b>1005570</b>		
3000K	730 lm	20°	16	<b>1005582</b>		
	700 lm	40°	22	<b>1005585</b>		
	720 lm	55°	25	<b>1005588</b>		
4000K	750 lm	20°	16	<b>1005600</b>		
	730 lm	40°	22	<b>1005605</b>		
	740 lm	55°	25	<b>1005608</b>		

# SLV NUMINOS® MOVE S



## DL

S



### Produktangaben:

250 mA

Leistungsaufnahme: 8,6W

Material: Aluminium / Polycarbonat (PC)

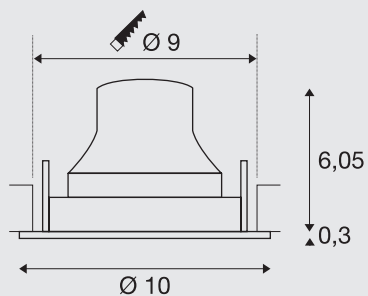

### Hinweis:

Niederspannungsstecker

Treiber exkl.

Passende Treiber, Diffusoren und Reduzierringe finden Sie auf den Seiten 50-53.



schwarz

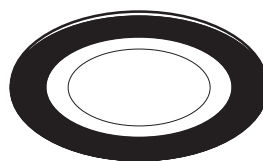

schwarz



weiß



chrom



schwarz

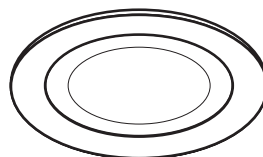

weiß



weiß



chrom





ART. NR.

2700K	670lm	20°	19	<b>1005319</b>
	670lm	40°	19	<b>1005322</b>
	670lm	55°	22	<b>1005325</b>
3000K	690lm	20°	19	<b>1005337</b>
	690lm	40°	19	<b>1005340</b>
	690lm	55°	22	<b>1005343</b>
4000K	730lm	20°	19	<b>1005355</b>
	730lm	40°	19	<b>1005358</b>
	730lm	55°	22	<b>1005361</b>
2700K	720lm	20°	19	<b>1005320</b>
	720lm	40°	19	<b>1005323</b>
	720lm	55°	22	<b>1005326</b>
3000K	730lm	20°	19	<b>1005338</b>
	730lm	40°	19	<b>1005341</b>
	730lm	55°	22	<b>1005344</b>
4000K	790lm	20°	19	<b>1005356</b>
	790lm	40°	19	<b>1005359</b>
	790lm	55°	22	<b>1005362</b>
2700K	690lm	20°	19	<b>1005321</b>
	690lm	40°	19	<b>1005324</b>
	690lm	55°	22	<b>1005327</b>
3000K	700lm	20°	19	<b>1005339</b>
	700lm	40°	19	<b>1005342</b>
	700lm	55°	22	<b>1005345</b>
4000K	750lm	20°	19	<b>1005357</b>
	750lm	40°	19	<b>1005360</b>
	750lm	55°	22	<b>1005363</b>
2700K	670lm	20°	19	<b>1005328</b>
	670lm	40°	19	<b>1005331</b>
	670lm	55°	22	<b>1005334</b>
3000K	690lm	20°	19	<b>1005346</b>
	690lm	40°	19	<b>1005349</b>
	690lm	55°	22	<b>1005352</b>
4000K	730lm	20°	19	<b>1005364</b>
	730lm	40°	19	<b>1005367</b>
	730lm	55°	22	<b>1005370</b>
2700K	720lm	20°	19	<b>1005329</b>
	720lm	40°	19	<b>1005332</b>
	720lm	55°	22	<b>1005335</b>
3000K	730lm	20°	19	<b>1005347</b>
	730lm	40°	19	<b>1005350</b>
	730lm	55°	22	<b>1005353</b>
4000K	790lm	20°	19	<b>1005365</b>
	790lm	40°	19	<b>1005368</b>
	790lm	55°	22	<b>1005371</b>
2700K	690lm	20°	19	<b>1005330</b>
	690lm	40°	19	<b>1005333</b>
	690lm	55°	22	<b>1005336</b>
3000K	700lm	20°	19	<b>1005348</b>
	700lm	40°	19	<b>1005351</b>
	700lm	55°	22	<b>1005354</b>
4000K	750lm	20°	19	<b>1005366</b>
	750lm	40°	19	<b>1005369</b>
	750lm	55°	22	<b>1005372</b>



# SLV NUMINOS® MOVE M DL



M



## Produktangaben:

500mA

Leistungsaufnahme: 17,5W

Material: Aluminium / Polycarbonat (PC)

Einbaumaße: Ø: 12 cm T: 10 cm

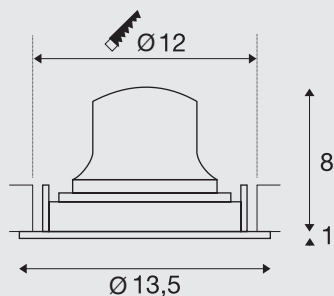

## Hinweis:

Niederspannungsstecker

Treiber exkl.

Passende Treiber, Diffusoren und Reduzierringe finden Sie auf den Seiten 50-53.



schwarz

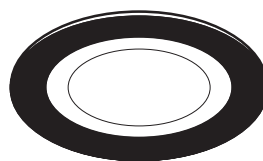

schwarz



weiß



chrom



schwarz

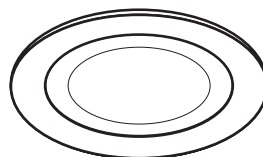

weiß



weiß



chrom



ART. NR.

2700K	1460lm	20°	19	<b>1003553</b>
	1460lm	40°	22	<b>1003556</b>
	1460lm	55°	22	<b>1003559</b>
3000K	1500lm	20°	19	<b>1003577</b>
	1500lm	40°	22	<b>1003580</b>
	1500lm	55°	22	<b>1003583</b>
4000K	1600lm	20°	19	<b>1003601</b>
	1600lm	40°	22	<b>1003604</b>
	1600lm	55°	22	<b>1003607</b>
2700K	1600lm	20°	22	<b>1003554</b>
	1600lm	40°	19	<b>1003557</b>
	1600lm	55°	22	<b>1003560</b>
3000K	1600lm	20°	22	<b>1003578</b>
	1600lm	40°	22	<b>1003581</b>
	1600lm	55°	22	<b>1003584</b>
4000K	1750lm	20°	22	<b>1003602</b>
	1750lm	40°	22	<b>1003605</b>
	1750lm	55°	22	<b>1003608</b>
2700K	1550lm	20°	19	<b>1003555</b>
	1550lm	40°	19	<b>1003558</b>
	1550lm	55°	19	<b>1003561</b>
3000K	1550lm	20°	19	<b>1003579</b>
	1550lm	40°	19	<b>1003582</b>
	1550lm	55°	19	<b>1003585</b>
4000K	1660lm	20°	19	<b>1003603</b>
	1660lm	40°	19	<b>1003606</b>
	1660lm	55°	19	<b>1003609</b>
2700K	1460lm	20°	19	<b>1003565</b>
	1460lm	40°	22	<b>1003568</b>
	1460lm	55°	22	<b>1003571</b>
3000K	1500lm	20°	19	<b>1003589</b>
	1500lm	40°	22	<b>1003592</b>
	1500lm	55°	22	<b>1003595</b>
4000K	1600lm	20°	19	<b>1003613</b>
	1600lm	40°	22	<b>1003616</b>
	1600lm	55°	22	<b>1003619</b>
2700K	1600lm	20°	22	<b>1003566</b>
	1600lm	40°	22	<b>1003569</b>
	1600lm	55°	22	<b>1003572</b>
3000K	1600lm	20°	22	<b>1003590</b>
	1600lm	40°	22	<b>1003593</b>
	1600lm	55°	22	<b>1003596</b>
4000K	1750lm	20°	22	<b>1003614</b>
	1750lm	40°	22	<b>1003617</b>
	1750lm	55°	22	<b>1003620</b>
2700K	1550lm	20°	19	<b>1003567</b>
	1550lm	40°	19	<b>1003570</b>
	1550lm	55°	19	<b>1003573</b>
3000K	1550lm	20°	19	<b>1003591</b>
	1550lm	40°	19	<b>1003594</b>
	1550lm	55°	19	<b>1003597</b>
4000K	1660lm	20°	19	<b>1003615</b>
	1660lm	40°	19	<b>1003618</b>
	1660lm	55°	19	<b>1003621</b>



# SLV NUMINOS® MOVE L DL



## Produktangaben:

750mA

Leistungsaufnahme: 25,4W

Material: Aluminium / Polycarbonat (PC)

Einbaumaße: Ø: 14,5 cm T: 10,5 cm

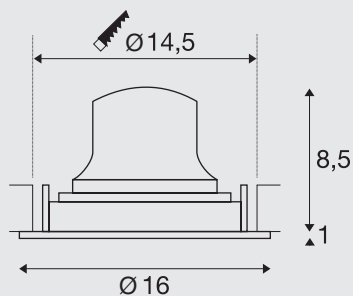

## Hinweis:

Niederspannungsstecker  
Treiber exkl.

Passende Treiber, Diffusoren und Reduzierringe finden Sie auf den Seiten 50-53.



schwarz

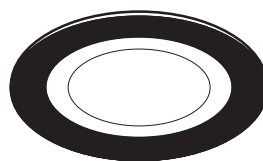

schwarz



weiß



chrom



schwarz

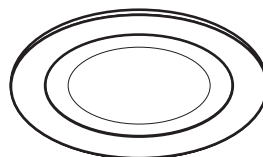

weiß



weiß



chrom





ART. NR.

2700K	2150lm	20°	22	<b>1003625</b>
	2150lm	40°	22	<b>1003628</b>
	2150lm	55°	22	<b>1003631</b>
3000K	2150lm	20°	22	<b>1003649</b>
	2150lm	40°	22	<b>1003652</b>
	2150lm	55°	25	<b>1003655</b>
4000K	2350lm	20°	22	<b>1003673</b>
	2350lm	40°	22	<b>1003676</b>
	2350lm	55°	25	<b>1003679</b>
2700K	2250lm	20°	19	<b>1003626</b>
	2250lm	40°	19	<b>1003629</b>
	2250lm	55°	22	<b>1003632</b>
3000K	2300lm	20°	19	<b>1003650</b>
	2300lm	40°	19	<b>1003653</b>
	2300lm	55°	22	<b>1003656</b>
4000K	2450lm	20°	19	<b>1003674</b>
	2450lm	40°	19	<b>1003677</b>
	2450lm	55°	22	<b>1003680</b>
2700K	2150lm	20°	19	<b>1003627</b>
	2150lm	40°	19	<b>1003630</b>
	2150lm	55°	19	<b>1003633</b>
3000K	2200lm	20°	19	<b>1003651</b>
	2200lm	40°	19	<b>1003654</b>
	2200lm	55°	19	<b>1003657</b>
4000K	2350lm	20°	19	<b>1003675</b>
	2350lm	40°	19	<b>1003678</b>
	2350lm	55°	19	<b>1003681</b>
2700K	2150lm	20°	22	<b>1003637</b>
	2150lm	40°	22	<b>1003640</b>
	2150lm	55°	22	<b>1003643</b>
3000K	2150lm	20°	22	<b>1003661</b>
	2150lm	40°	22	<b>1003664</b>
	2150lm	55°	25	<b>1003667</b>
4000K	2350lm	20°	22	<b>1003685</b>
	2350lm	40°	22	<b>1003688</b>
	2350lm	55°	25	<b>1003691</b>
2700K	2250lm	20°	19	<b>1003638</b>
	2250lm	40°	19	<b>1003641</b>
	2250lm	55°	22	<b>1003644</b>
3000K	2300lm	20°	19	<b>1003662</b>
	2300lm	40°	19	<b>1003665</b>
	2300lm	55°	22	<b>1003668</b>
4000K	2450lm	20°	19	<b>1003686</b>
	2450lm	40°	19	<b>1003689</b>
	2450lm	55°	22	<b>1003692</b>
2700K	2150lm	20°	19	<b>1003639</b>
	2150lm	40°	19	<b>1003642</b>
	2150lm	55°	19	<b>1003645</b>
3000K	2200lm	20°	19	<b>1003663</b>
	2200lm	40°	19	<b>1003666</b>
	2200lm	55°	19	<b>1003669</b>
4000K	2350lm	20°	19	<b>1003687</b>
	2350lm	40°	19	<b>1003690</b>
	2350lm	55°	19	<b>1003693</b>



# SLV NUMINOS® MOVE XL



## DL

### XL



#### Produktangaben:

1050mA

Leistungsaufnahme: 37,4W

Material: Aluminium / Polycarbonat (PC)

Einbaumaße: Ø: 17,5 cm T: 13 cm

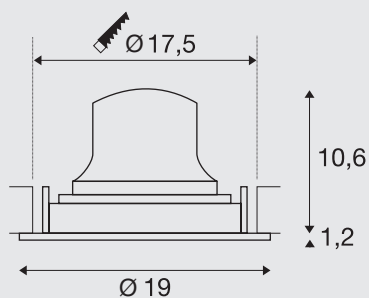

#### Hinweis:

Niederspannungsstecker

Treiber exkl.

Passende Treiber, Diffusoren und Reduzierringe finden Sie auf den Seiten 50-53.



schwarz

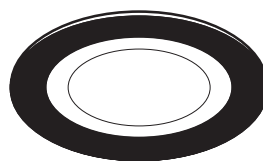

schwarz



weiß



chrom



schwarz

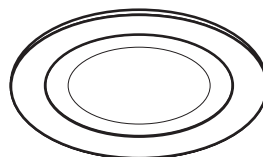

weiß



weiß



chrom



ART. NR.

2700K	3300lm	20°	22	<b>1003697</b>
	3300lm	40°	22	<b>1003700</b>
	3300lm	55°	22	<b>1003703</b>
3000K	3300lm	20°	22	<b>1003721</b>
	3300lm	40°	22	<b>1003724</b>
	3300lm	55°	22	<b>1003727</b>
4000K	3600lm	20°	22	<b>1003745</b>
	3600lm	40°	22	<b>1003748</b>
	3600lm	55°	25	<b>1003751</b>
2700K	3500lm	20°	19	<b>1003698</b>
	3500lm	40°	19	<b>1003701</b>
	3500lm	55°	19	<b>1003704</b>
3000K	3550lm	20°	19	<b>1003722</b>
	3550lm	40°	19	<b>1003725</b>
	3550lm	55°	19	<b>1003728</b>
4000K	3800lm	20°	19	<b>1003746</b>
	3800lm	40°	19	<b>1003749</b>
	3800lm	55°	19	<b>1003752</b>
2700K	3400lm	20°	19	<b>1003699</b>
	3400lm	40°	19	<b>1003702</b>
	3400lm	55°	19	<b>1003705</b>
3000K	3500lm	20°	19	<b>1003723</b>
	3500lm	40°	19	<b>1003726</b>
	3500lm	55°	19	<b>1003729</b>
4000K	3750lm	20°	19	<b>1003747</b>
	3750lm	40°	19	<b>1003750</b>
	3750lm	55°	19	<b>1003753</b>
2700K	3300lm	20°	22	<b>1003709</b>
	3300lm	40°	22	<b>1003712</b>
	3300lm	55°	22	<b>1003715</b>
3000K	3300lm	20°	22	<b>1003733</b>
	3300lm	40°	22	<b>1003736</b>
	3300lm	55°	22	<b>1003739</b>
4000K	3600lm	20°	22	<b>1003757</b>
	3600lm	40°	22	<b>1003760</b>
	3600lm	55°	25	<b>1003763</b>
2700K	3500lm	20°	19	<b>1003710</b>
	3500lm	40°	19	<b>1003713</b>
	3500lm	55°	19	<b>1003716</b>
3000K	3550lm	20°	19	<b>1003734</b>
	3550lm	40°	19	<b>1003737</b>
	3550lm	55°	19	<b>1003740</b>
4000K	3800lm	20°	19	<b>1003758</b>
	3800lm	40°	19	<b>1003761</b>
	3800lm	55°	19	<b>1003764</b>
2700K	3400lm	20°	19	<b>1003711</b>
	3400lm	40°	19	<b>1003714</b>
	3400lm	55°	19	<b>1003717</b>
3000K	3500lm	20°	19	<b>1003735</b>
	3500lm	40°	19	<b>1003738</b>
	3500lm	55°	19	<b>1003741</b>
4000K	3750lm	20°	19	<b>1003759</b>
	3750lm	40°	19	<b>1003762</b>
	3750lm	55°	19	<b>1003765</b>



# SLV NUMINOS® GIMBLE XS



## DL

### XS



#### Produktangaben:

200mA

Leistungsaufnahme: 7W

Material: Aluminium / Polycarbonat (PC)

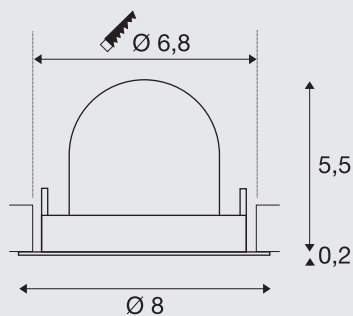
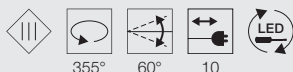

#### Hinweis:

Niederspannungsstecker

Treiber exkl.

Passende Treiber, Diffusoren und Reduzierringe finden Sie auf den Seiten 50-53.



schwarz

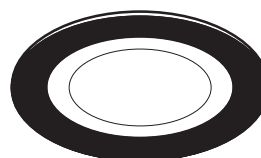

schwarz



weiß



chrom



schwarz

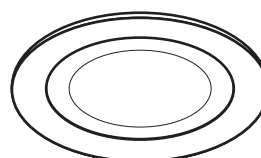

weiß



weiß



chrom



ART. NR.

2700K	640lm	20°	16	<b>1005813</b>		
	620lm	40°	22	<b>1005816</b>		
	640lm	55°	25	<b>1005819</b>		
3000K	700lm	20°	16	<b>1005831</b>		
	670lm	40°	22	<b>1005834</b>		
	690lm	55°	25	<b>1005837</b>		
4000K	720lm	20°	16	<b>1005849</b>		
	700lm	40°	22	<b>1005852</b>		
	710lm	55°	25	<b>1005855</b>		
2700K	670lm	20°	16	<b>1005814</b>		
	650lm	40°	22	<b>1005817</b>		
	670lm	55°	25	<b>1005820</b>		
3000K	730lm	20°	16	<b>1005832</b>		
	700lm	40°	22	<b>1005835</b>		
	720lm	55°	25	<b>1005838</b>		
4000K	750lm	20°	16	<b>1005850</b>		
	730lm	40°	22	<b>1005853</b>		
	740lm	55°	25	<b>1005856</b>		
2700K	670lm	20°	16	<b>1005815</b>		
	650lm	40°	22	<b>1005818</b>		
	670lm	55°	25	<b>1005821</b>		
3000K	730lm	20°	16	<b>1005833</b>		
	700lm	40°	22	<b>1005836</b>		
	720lm	55°	25	<b>1005839</b>		
4000K	750lm	20°	16	<b>1005851</b>		
	730lm	40°	22	<b>1005854</b>		
	740lm	55°	25	<b>1005857</b>		
2700K	640lm	20°	16	<b>1005822</b>		
	620lm	40°	22	<b>1005825</b>		
	640lm	55°	25	<b>1005828</b>		
3000K	700lm	20°	16	<b>1005840</b>		
	670lm	40°	22	<b>1005843</b>		
	690lm	55°	25	<b>1005846</b>		
4000K	720lm	20°	16	<b>1005858</b>		
	700lm	40°	22	<b>1005861</b>		
	710lm	55°	25	<b>1005864</b>		
2700K	670lm	20°	16	<b>1005823</b>		
	650lm	40°	22	<b>1005826</b>		
	670lm	55°	25	<b>1005829</b>		
3000K	730lm	20°	16	<b>1005841</b>		
	700lm	40°	22	<b>1005844</b>		
	720lm	55°	25	<b>1005847</b>		
4000K	750lm	20°	16	<b>1005859</b>		
	730lm	40°	22	<b>1005862</b>		
	740lm	55°	25	<b>1005865</b>		
2700K	670lm	20°	16	<b>1005824</b>		
	650lm	40°	22	<b>1005827</b>		
	670lm	55°	25	<b>1005830</b>		
3000K	730lm	20°	16	<b>1005842</b>		
	700lm	40°	22	<b>1005845</b>		
	720lm	55°	25	<b>1005848</b>		
4000K	750lm	20°	16	<b>1005860</b>		
	730lm	40°	22	<b>1005863</b>		
	740lm	55°	25	<b>1005866</b>		



# SLV NUMINOS® GIMBLE S DL



S



## Produktangaben:

250mA

Leistungsaufnahme: 8,6 W

Material: Aluminium / Polycarbonat (PC)

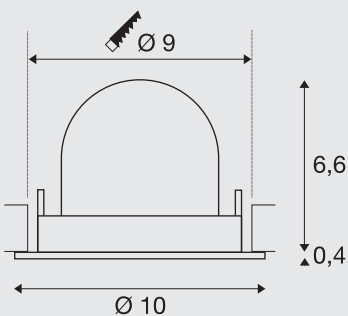
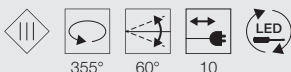

## Hinweis:

Niederspannungsstecker  
Treiber exkl.

Passende Treiber, Diffusoren und Reduzierringe finden Sie auf den Seiten 50-53.



schwarz

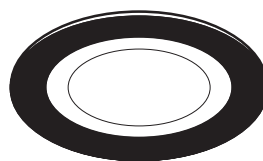

schwarz



weiß



chrom



schwarz

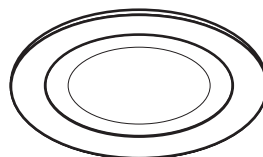

weiß



weiß



chrom



ART. NR.

2700K	670lm	20°	19	<b>1005867</b>
	670lm	40°	19	<b>1005870</b>
	670lm	55°	22	<b>1005873</b>
3000K	690lm	20°	19	<b>1005885</b>
	690lm	40°	19	<b>1005888</b>
	690lm	55°	22	<b>1005891</b>
4000K	730lm	20°	19	<b>1005903</b>
	730lm	40°	19	<b>1005906</b>
	730lm	55°	22	<b>1005909</b>
2700K	720lm	20°	19	<b>1005868</b>
	720lm	40°	19	<b>1005871</b>
	720lm	55°	22	<b>1005874</b>
3000K	730lm	20°	19	<b>1005886</b>
	730lm	40°	19	<b>1005889</b>
	730lm	55°	22	<b>1005892</b>
4000K	790lm	20°	19	<b>1005904</b>
	790lm	40°	19	<b>1005907</b>
	790lm	55°	22	<b>1005910</b>
2700K	690lm	20°	19	<b>1005869</b>
	690lm	40°	19	<b>1005872</b>
	690lm	55°	22	<b>1005875</b>
3000K	700lm	20°	19	<b>1005887</b>
	700lm	40°	19	<b>1005890</b>
	700lm	55°	22	<b>1005893</b>
4000K	750lm	20°	19	<b>1005905</b>
	750lm	40°	19	<b>1005908</b>
	750lm	55°	22	<b>1005911</b>
2700K	670lm	20°	19	<b>1005876</b>
	670lm	40°	19	<b>1005879</b>
	670lm	55°	22	<b>1005882</b>
3000K	690lm	20°	19	<b>1005894</b>
	690lm	40°	19	<b>1005897</b>
	690lm	55°	22	<b>1005900</b>
4000K	730lm	20°	19	<b>1005912</b>
	730lm	40°	19	<b>1005915</b>
	730lm	55°	22	<b>1005918</b>
2700K	720lm	20°	19	<b>1005877</b>
	720lm	40°	19	<b>1005880</b>
	720lm	55°	22	<b>1005883</b>
3000K	730lm	20°	19	<b>1005895</b>
	730lm	40°	19	<b>1005898</b>
	730lm	55°	22	<b>1005901</b>
4000K	790lm	20°	19	<b>1005913</b>
	790lm	40°	19	<b>1005916</b>
	790lm	55°	22	<b>1005919</b>
2700K	690lm	20°	19	<b>1005878</b>
	690lm	40°	19	<b>1005881</b>
	690lm	55°	22	<b>1005884</b>
3000K	700lm	20°	19	<b>1005896</b>
	700lm	40°	19	<b>1005899</b>
	700lm	55°	22	<b>1005902</b>
4000K	750lm	20°	19	<b>1005914</b>
	750lm	40°	19	<b>1005917</b>
	750lm	55°	22	<b>1005920</b>



# SLV NUMINOS® GIMBLE M DL



M



## Produktangaben:

500mA

Leistungsaufnahme: 17,5W

Material: Aluminium / Polycarbonat (PC)

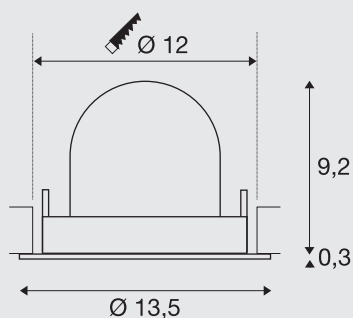
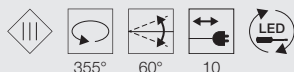

## Hinweis:

Niederspannungsstecker  
Treiber exkl.

Passende Treiber, Diffusoren und Reduzierringe finden Sie auf den Seiten 50-53.



schwarz

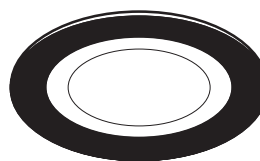

schwarz



weiß



chrom



schwarz

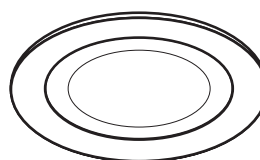

weiß



weiß



chrom



ART. NR.

2700K	1460lm	20°	22	<b>1005921</b>
	1460lm	40°	22	<b>1005924</b>
	1460lm	55°	22	<b>1005927</b>
3000K	1500lm	20°	22	<b>1005939</b>
	1500lm	40°	22	<b>1005942</b>
	1500lm	55°	22	<b>1005945</b>
4000K	1600lm	20°	22	<b>1005957</b>
	1600lm	40°	22	<b>1005960</b>
	1600lm	55°	22	<b>1005963</b>
2700K	1600lm	20°	22	<b>1005922</b>
	1600lm	40°	22	<b>1005925</b>
	1600lm	55°	22	<b>1005928</b>
3000K	1600lm	20°	22	<b>1005940</b>
	1600lm	40°	22	<b>1005943</b>
	1600lm	55°	22	<b>1005946</b>
4000K	1750lm	20°	22	<b>1005958</b>
	1750lm	40°	22	<b>1005961</b>
	1750lm	55°	22	<b>1005964</b>
2700K	1550lm	20°	22	<b>1005923</b>
	1550lm	40°	22	<b>1005926</b>
	1550lm	55°	22	<b>1005929</b>
3000K	1550lm	20°	22	<b>1005941</b>
	1550lm	40°	22	<b>1005944</b>
	1550lm	55°	22	<b>1005947</b>
4000K	1660lm	20°	22	<b>1005959</b>
	1660lm	40°	22	<b>1005962</b>
	1660lm	55°	22	<b>1005965</b>
2700K	1460lm	20°	22	<b>1005930</b>
	1460lm	40°	22	<b>1005933</b>
	1460lm	55°	22	<b>1005936</b>
3000K	1500lm	20°	22	<b>1005948</b>
	1500lm	40°	22	<b>1005951</b>
	1500lm	55°	22	<b>1005954</b>
4000K	1600lm	20°	22	<b>1005966</b>
	1600lm	40°	22	<b>1005969</b>
	1600lm	55°	22	<b>1005972</b>
2700K	1600lm	20°	22	<b>1005931</b>
	1600lm	40°	22	<b>1005934</b>
	1600lm	55°	22	<b>1005937</b>
3000K	1600lm	20°	22	<b>1005949</b>
	1600lm	40°	22	<b>1005952</b>
	1600lm	55°	22	<b>1005955</b>
4000K	1750lm	20°	22	<b>1005967</b>
	1750lm	40°	22	<b>1005970</b>
	1750lm	55°	22	<b>1005973</b>
2700K	1550lm	20°	22	<b>1005932</b>
	1550lm	40°	22	<b>1005935</b>
	1550lm	55°	22	<b>1005938</b>
3000K	1550lm	20°	22	<b>1005950</b>
	1550lm	40°	22	<b>1005953</b>
	1550lm	55°	22	<b>1005956</b>
4000K	1660lm	20°	22	<b>1005968</b>
	1660lm	40°	22	<b>1005971</b>
	1660lm	55°	22	<b>1005974</b>



# SLV NUMINOS® GIMBLE L DL



## Produktangaben:

700mA

Leistungsaufnahme: 25,4W

Material: Aluminium / Polycarbonat (PC)

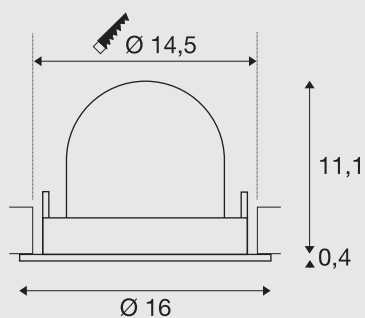
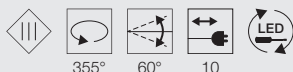

## Hinweis:

Niederspannungsstecker  
Treiber exkl.

Passende Treiber, Diffusoren und Reduzierringe finden Sie auf den Seiten 50-53.



■ schwarz

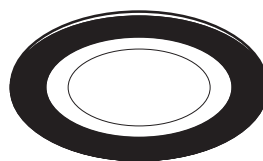

■ schwarz



□ weiß



■ chrom



■ schwarz

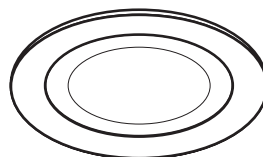

□ weiß



□ weiß



■ chrom





ART. NR.

2700K	2150lm	20°	22	<b>1005975</b>
	2150lm	40°	22	<b>1005978</b>
	2150lm	55°	22	<b>1005981</b>
3000K	2150lm	20°	22	<b>1005993</b>
	2150lm	40°	22	<b>1005996</b>
	2150lm	55°	22	<b>1005999</b>
4000K	2350lm	20°	22	<b>1006011</b>
	2350lm	40°	22	<b>1006014</b>
	2350lm	55°	22	<b>1006017</b>
2700K	2250lm	20°	22	<b>1005976</b>
	2250lm	40°	22	<b>1005979</b>
	2250lm	55°	22	<b>1005982</b>
3000K	2300lm	20°	22	<b>1005994</b>
	2300lm	40°	22	<b>1005997</b>
	2300lm	55°	22	<b>1006000</b>
4000K	2450lm	20°	22	<b>1006012</b>
	2450lm	40°	22	<b>1006015</b>
	2450lm	55°	22	<b>1006018</b>
2700K	2150lm	20°	22	<b>1005977</b>
	2150lm	40°	22	<b>1005980</b>
	2150lm	55°	22	<b>1005983</b>
3000K	2200lm	20°	22	<b>1005995</b>
	2200lm	40°	22	<b>1005998</b>
	2200lm	55°	22	<b>1006001</b>
4000K	2350lm	20°	22	<b>1006013</b>
	2350lm	40°	22	<b>1006016</b>
	2350lm	55°	22	<b>1006019</b>
2700K	2150lm	20°	22	<b>1005984</b>
	2150lm	40°	22	<b>1005987</b>
	2150lm	55°	22	<b>1005990</b>
3000K	2150lm	20°	22	<b>1006002</b>
	2150lm	40°	22	<b>1006005</b>
	2150lm	55°	22	<b>1006008</b>
4000K	2350lm	20°	22	<b>1006020</b>
	2350lm	40°	22	<b>1006023</b>
	2350lm	55°	22	<b>1006026</b>
2700K	2250lm	20°	22	<b>1005985</b>
	2250lm	40°	22	<b>1005988</b>
	2250lm	55°	22	<b>1005991</b>
3000K	2300lm	20°	22	<b>1006003</b>
	2300lm	40°	22	<b>1006006</b>
	2300lm	55°	22	<b>1006009</b>
4000K	2450lm	20°	22	<b>1006021</b>
	2450lm	40°	22	<b>1006024</b>
	2450lm	55°	22	<b>1006027</b>
2700K	2150lm	20°	22	<b>1005986</b>
	2150lm	40°	22	<b>1005989</b>
	2150lm	55°	22	<b>1005992</b>
3000K	2200lm	20°	22	<b>1006004</b>
	2200lm	40°	22	<b>1006007</b>
	2200lm	55°	22	<b>1006010</b>
4000K	2350lm	20°	22	<b>1006022</b>
	2350lm	40°	22	<b>1006025</b>
	2350lm	55°	22	<b>1006028</b>



# SLV NUMINOS® GIMBLE XL



## DL

### XL



#### Produktangaben:

1000/1050mA

Leistungsaufnahme: 37,4W

Material: Aluminium / Polycarbonat (PC)

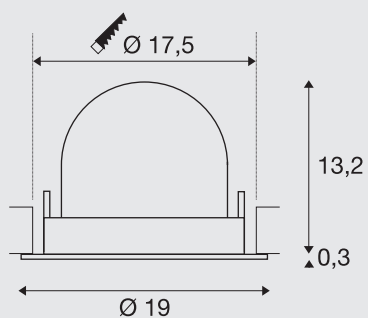
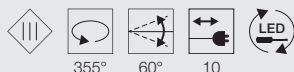

#### Hinweis:

Niederspannungsstecker  
Treiber exkl.

Passende Treiber, Diffusoren und Reduzierringe finden Sie auf den Seiten 50-53.



schwarz

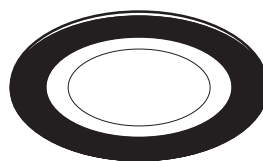

schwarz



weiß



chrom



schwarz

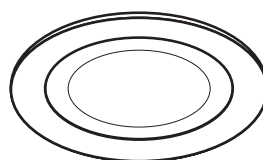

weiß



weiß



chrom



ART. NR.

2700K	3300lm	20°	22	<b>1006029</b>
	3300lm	40°	22	<b>1006032</b>
	3300lm	55°	22	<b>1006035</b>
3000K	3300lm	20°	22	<b>1006047</b>
	3300lm	40°	22	<b>1006050</b>
	3300lm	55°	22	<b>1006053</b>
4000K	3600lm	20°	22	<b>1006065</b>
	3600lm	40°	22	<b>1006068</b>
	3600lm	55°	22	<b>1006071</b>
2700K	3500lm	20°	22	<b>1006030</b>
	3500lm	40°	22	<b>1006033</b>
	3500lm	55°	22	<b>1006036</b>
3000K	3550lm	20°	22	<b>1006048</b>
	3550lm	40°	22	<b>1006051</b>
	3550lm	55°	22	<b>1006054</b>
4000K	3800lm	20°	22	<b>1006066</b>
	3800lm	40°	22	<b>1006069</b>
	3800lm	55°	22	<b>1006072</b>
2700K	3400lm	20°	22	<b>1006031</b>
	3400lm	40°	22	<b>1006034</b>
	3400lm	55°	22	<b>1006037</b>
3000K	3500lm	20°	22	<b>1006049</b>
	3500lm	40°	22	<b>1006052</b>
	3500lm	55°	22	<b>1006055</b>
4000K	3750lm	20°	22	<b>1006067</b>
	3750lm	40°	22	<b>1006070</b>
	3750lm	55°	22	<b>1006073</b>
2700K	3300lm	20°	22	<b>1006038</b>
	3300lm	40°	22	<b>1006041</b>
	3300lm	55°	22	<b>1006044</b>
3000K	3300lm	20°	22	<b>1006056</b>
	3300lm	40°	22	<b>1006059</b>
	3300lm	55°	22	<b>1006062</b>
4000K	3600lm	20°	22	<b>1006074</b>
	3600lm	40°	22	<b>1006077</b>
	3600lm	55°	22	<b>1006080</b>
2700K	3500lm	20°	22	<b>1006039</b>
	3500lm	40°	22	<b>1006042</b>
	3500lm	55°	22	<b>1006045</b>
3000K	3550lm	20°	22	<b>1006057</b>
	3550lm	40°	22	<b>1006060</b>
	3550lm	55°	22	<b>1006063</b>
4000K	3800lm	20°	22	<b>1006075</b>
	3800lm	40°	22	<b>1006078</b>
	3800lm	55°	22	<b>1006081</b>
2700K	3400lm	20°	22	<b>1006040</b>
	3400lm	40°	22	<b>1006043</b>
	3400lm	55°	22	<b>1006046</b>
3000K	3500lm	20°	22	<b>1006058</b>
	3500lm	40°	22	<b>1006061</b>
	3500lm	55°	22	<b>1006064</b>
4000K	3750lm	20°	22	<b>1006076</b>
	3750lm	40°	22	<b>1006079</b>
	3750lm	55°	22	<b>1006082</b>



# ZUBEHÖR

## Perfekte Treiberzuordnung

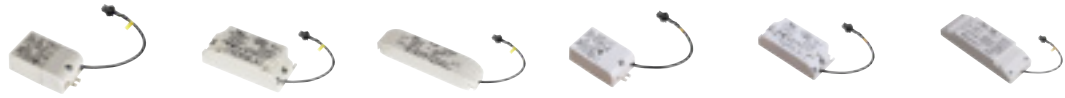

LED Treiber  
200mA, 10W QC

LED Treiber  
200mA, 10W,  
PHASE QC

LED Treiber  
200mA, 30W,  
DALI QC

LED Treiber  
250mA, 10W

LED Treiber  
250mA, 10W,  
PHASE

LED Treiber  
250mA, 20W,  
DALI

**XS**

**XS**

**XS**

**S**

**S**

**S**

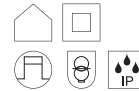
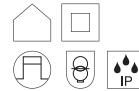
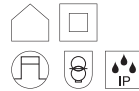
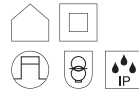

200mA

200mA

200mA

250mA

250mA

250/350/500/700mA

<b>Material</b>	Polycarbonat (PC)	Polycarbonat (PC)	Polycarbonat (PC)	Polycarbonat (PC)	Polycarbonat (PC)	Polycarbonat (PC)
<b>Farbe</b>	weiß	weiß	weiß	weiß	weiß	weiß
<b>Spannung prim.</b>	200-240V ~50/60Hz	200-240V ~50/60Hz	200-240V ~50/60Hz	220-240V ~50/60Hz	220-240V ~50/60Hz	220-240V ~50/60Hz
<b>Spannung sek.</b>	29-42V DC	30-42V DC	15-54V DC	26-40V	30-42V	6-60V
<b>Ausgangsstrom</b>	200mA	200mA	200mA	250mA	250mA	250mA
<b>Anzahl Ausgänge sek.</b>	1	1	1	1	1	1
<b>Leistung von</b>	5,8W	6W	3,8W	6,5W	7,5W	1,5W
<b>Leistung bis</b>	8,4W	8,4W	13,5W	10W	10W	15W
<b>Umgebungstemp. min.</b>	-	-	-	-20°C	-20°C	-20°C
<b>Umgebungstemp. max.</b>	-	-	-	45°C	50°C	50°C
<b>Temperaturschutz</b>	110°C	110°C	110°C	110°C	110°C	110°C
<b>IP-Schutzart</b>	IP 20	IP 20	IP 20	IP 20	IP 20	IP 20
<b>Dimmbar</b>	-	PHASE C	DALI	-	PHASE C	DALI
<b>Länge</b>	6,5 cm	8,5 cm	18 cm	6,5 cm	8,5 cm	15 cm
<b>Breite</b>	3,9 cm	4,1 cm	4,5 cm	3,9 cm	3,9 cm	5,2 cm
<b>Höhe</b>	3,5 cm	3 cm	3 cm	2 cm	2,2 cm	2,8 cm
<b>Art. Nr.</b>	<b>1005610</b>	<b>1005609</b>	<b>1005611</b>	<b>1004058</b>	<b>1004055</b>	<b>1004067</b>

## Diffusoren

**XS**

**S**

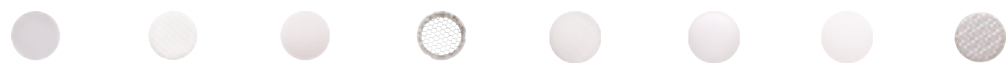

Diffusor  
elliptisch

Diffusor  
prismatisch

Diffusor  
gefrostet

Diffusor  
Wabe

Diffusor  
elliptisch

Diffusor  
prismatisch

Diffusor  
gefrostet

Diffusor  
Wabe

<b>Art. Nr.</b>	<b>1005612</b>	<b>1005613</b>	<b>1005614</b>	<b>1005615</b>	<b>1004786</b>	<b>1004787</b>	<b>1004788</b>	<b>1004789</b>
-----------------	----------------	----------------	----------------	----------------	----------------	----------------	----------------	----------------

# ZUBEHÖR



LED Treiber  
500mA, 30W



LED Treiber  
500mA, 30W,  
PHASE



LED Treiber  
500mA, 40W,  
DALI

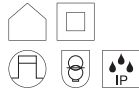
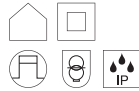
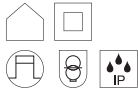

500/600/700mA

500mA

500/700/1050mA

<b>Material</b>	Polycarbonat (PC)	Polycarbonat (PC)	Polycarbonat (PC)
<b>Farbe</b>	weiß	weiß	weiß
<b>Spannung prim.</b>	220-240V ~50/60Hz	220-240V ~50/60Hz	220-240V ~50/60Hz
<b>Spannung sek.</b>	30-42V	25-42V	6-58V
<b>Ausgangsstrom</b>	500mA	500mA	500mA
<b>Anzahl Ausgänge sek.</b>	1	1	1
<b>Leistung von</b>	15W	12,5W	1,5W
<b>Leistung bis</b>	29,5W	21W	40,6W
<b>Umgebungstemp. min.</b>	-20°C	-25°C	-25°C
<b>Umgebungstemp. max.</b>	50°C	50°C	50°C
<b>Temperaturschutz</b>	110°C	110°C	110°C
<b>IP-Schutzart</b>	IP 20	IP 20	IP 20
<b>Dimmbar</b>	-	PHASE C	DALI
<b>Länge</b>	14,7 cm	11,5 cm	12,3 cm
<b>Breite</b>	4,3 cm	4,1 cm	7,9 cm
<b>Höhe</b>	3 cm	2,5 cm	2,4 cm
<b>Art. Nr.</b>	<b>1004064</b>	<b>1004054</b>	<b>1004069</b>



Diffusor  
elliptisch



Diffusor  
prismatisch



Diffusor  
gefrostet



Diffusor  
Wabe

<b>Art. Nr.</b>	<b>1004790</b>	<b>1004791</b>	<b>1004792</b>	<b>1004793</b>
-----------------	----------------	----------------	----------------	----------------



# ZUBEHÖR

## Perfekte Treiberzuordnung



LED Treiber  
1050mA, 40W



LED Treiber  
700mA, 30W,  
PHASE



LED Treiber  
700mA, 40W, DALI



LED Treiber  
1050mA, 40W



LED Treiber  
1000mA, 40W,  
PHASE



LED Treiber  
1050mA, 50W,  
DALI

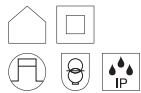

500/600/700mA

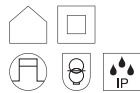

700mA

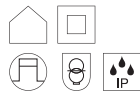

700mA

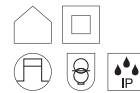

800/900/1050mA

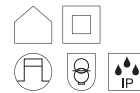

1000mA



1050mA

Material	Polycarbonat (PC)	Polycarbonat (PC)	Polycarbonat (PC)	Polycarbonat (PC)	Polycarbonat (PC)	Polycarbonat (PC)
Farbe	weiß	weiß	weiß	weiß	weiß	weiß
Spannung prim.	220-240V ~50/60Hz	220-240V ~50/60Hz	220-240V ~50/60Hz	220-240V ~50/60Hz	220-240V ~50/60Hz	220-240V ~50/60Hz
Spannung sek.	30-42V	30-42V	6-58V	30-42V	25-40V	6-58V
Ausgangsstrom	700mA	700mA	250/350/500/700mA	1050mA	1050mA	1050mA
Anzahl Ausgänge sek.	1	1	1	1	1	1
Leistung von	15W	21W	1,5W	24W	26,3W	4,2W
Leistung bis	29,5W	29,4W	40,6W	44W	42W	50W
Umgebungstemp. min.	-20°C	-20°C	-25°C	-20°C	-20°C	-25°C
Umgebungstemp. max.	50°C	50°C	50°C	50°C	50°C	50°C
Temperaturschutz	110°C	110°C	110°C	110°C	110°C	110°C
IP-Schutzart	IP 20	IP 20	IP 20	IP 20	IP 20	IP 20
Dimmbar	-	PHASE C	DALI	-	PHASE C	DALI
Länge	14,7 cm	11,5 cm	12,3 cm	9,7 cm	14,5 cm	12,3 cm
Breite	4,3 cm	4,4 cm	7,9 cm	4,3 cm	4 cm	7,9 cm
Höhe	3 cm	3 cm	2,4 cm	3 cm	3 cm	2,4 cm
Art. Nr.	1004062	1004065	1004070	1004059	1004066	1004071

## Diffusoren



Diffusor  
elliptisch

1004794



Diffusor  
prismatisch

1004795



Diffusor  
gefrostet

1004796



Diffusor  
Wabe

1004797



Diffusor  
elliptisch

1004798



Diffusor  
prismatisch

1004799



Diffusor  
gefrostet

1004800



Diffusor  
Wabe

1004801

Art. Nr.	1004794	1004795	1004796	1004797	1004798	1004799	1004800	1004801
----------	---------	---------	---------	---------	---------	---------	---------	---------

# ZEIT FÜR VERÄNDERUNG. ZEIT FÜR EIN UPDATE.

Eine veraltete, oft noch mit konventionellen Leuchtmitteln ausgestattete Deckeneinbauleuchte soll einer energieeffizienten und kostensparenden Alternative weichen. Bei der Demontage finden Sie dabei häufig einen größeren Deckenausschnitt vor als benötigt.

## Hier bietet SLV die passende Lösung: unsere neuen Reduzierringe.

Die Reduzierringe decken den größeren Deckenausschnitt komplett ab und geben gleichzeitig Ihrer neuen, kompakten Deckeneinbauleuchte perfekten Halt.

## Sauber, zeitsparend, unkompliziert.

Und dabei perfekt abgestimmt auf das SLV NUMINOS® Down – und Spotlightsystem.



1. Die alte Leuchte hat einen größeren Durchmesser, als die Neue? Kein Problem!



2. Deinstallieren Sie die alte Deckeneinbauleuchte.



3. Setzen Sie einen der neuen Leuchte angepassten Reduzierring ein.



4. Durch den Reduzierring haben Sie den vergrößerten Deckenausschnitt gänzlich abgedeckt.

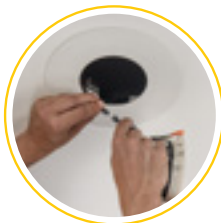

5. Nun können Sie den elektrischen Anschluss und die Installation der neuen Deckeneinbauleuchte abschließen.



6. Dank des Reduzierings ist der größere Deckenausschnitt nun nicht mehr sichtbar.

### Reduzierring rund

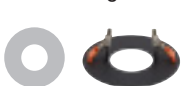

Material	Stahl	Stahl	Stahl	Stahl	Stahl
Außen-Ø	16 cm	16 cm	24 cm	24 cm	24 cm
Höhe	5,3 cm	5,3 cm	5,3 cm	5,3 cm	5,3 cm
Innen-Ø	7 cm	9 cm	12 cm	15 cm	18 cm
Deckenausschnitt	8,5 - 13 cm	12 - 15 cm	14 - 18 cm	17 - 20 cm	20 - 22 cm
Materialdicke	3 cm	3 cm	3 cm	3 cm	3 cm
Art. Nr. schwarz	1006135	1006139	1006143	1006147	1006151
Art. Nr. weiß	1006136	1006140	1006144	1006148	1006152

### Reduzierring eckig



Material	Stahl	Stahl	Stahl	Stahl	Stahl
Länge	16 cm	16 cm	24 cm	24 cm	24 cm
Breite	16 cm	16 cm	24 cm	24 cm	24 cm
Höhe	5,3 cm	5,3 cm	5,3 cm	5,3 cm	5,3 cm
Innen-Ø	7 cm	9 cm	12 cm	15 cm	18 cm
Deckenausschnitt	8,5 - 13 cm	12 - 15 cm	14 - 18 cm	17 - 20 cm	20 - 22 cm
Materialdicke	3 cm	3 cm	3 cm	3 cm	3 cm
Art. Nr. schwarz	1006137	1006141	1006145	1006149	1006153
Art. Nr. weiß	1006138	1006142	1006146	1006150	1006154

# SLV NUMINOS® S



## 3Ph.

### Produktangaben:

220-240V ~50/60Hz | 250mA

Systemleistung: 11W

Material: Aluminium / Polycarbonat (PC)

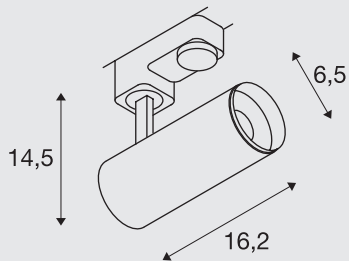

■ schwarz

### Hinweis:

Zierring auch in Weiß erhältlich



Zierring S ■ weiß Art. Nr. 1006167

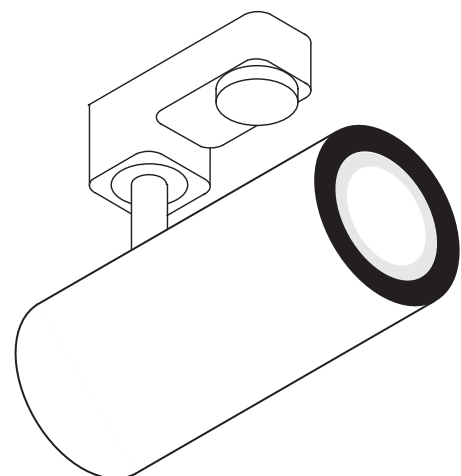

□ weiß



ART. NR.



	985lm	24°	16	<b>1004074</b>
2700K	985lm	36°	16	<b>1004075</b>
	980lm	60°	19	<b>1004076</b>
3000K	1020lm	24°	13	<b>1004082</b>
	1020lm	36°	13	<b>1004083</b>
	1020lm	60°	19	<b>1004084</b>
4000K	1100lm	24°	16	<b>1004090</b>
	1100lm	36°	16	<b>1004091</b>
	1100lm	60°	19	<b>1004092</b>



	985lm	24°	16	<b>1004362</b>
2700K	985lm	36°	16	<b>1004363</b>
	980lm	60°	19	<b>1004364</b>
3000K	1020lm	24°	13	<b>1004370</b>
	1020lm	36°	13	<b>1004371</b>
	1020lm	60°	19	<b>1004372</b>
4000K	1100lm	24°	16	<b>1004378</b>
	1100lm	36°	16	<b>1004379</b>
	1100lm	60°	19	<b>1004380</b>



	985lm	24°	16	<b>1004078</b>
2700K	985lm	36°	16	<b>1004079</b>
	980lm	60°	19	<b>1004080</b>
3000K	1020lm	24°	13	<b>1004086</b>
	1020lm	36°	13	<b>1004087</b>
	1020lm	60°	19	<b>1004088</b>
4000K	1100lm	24°	16	<b>1004094</b>
	1100lm	36°	16	<b>1004095</b>
	1100lm	60°	19	<b>1004096</b>



	985lm	24°	16	<b>1004366</b>
2700K	985lm	36°	16	<b>1004367</b>
	980lm	60°	19	<b>1004368</b>
3000K	1020lm	24°	13	<b>1004374</b>
	1020lm	36°	13	<b>1004375</b>
	1020lm	60°	19	<b>1004376</b>
4000K	1100lm	24°	16	<b>1004382</b>
	1100lm	36°	16	<b>1004383</b>
	1100lm	60°	19	<b>1004384</b>



# SLV NUMINOS® M



## 3Ph.

### Produktangaben:

220-240V ~50/60Hz | 500mA

Systemleistung: 20W

Material: Aluminium / Polycarbonat (PC)

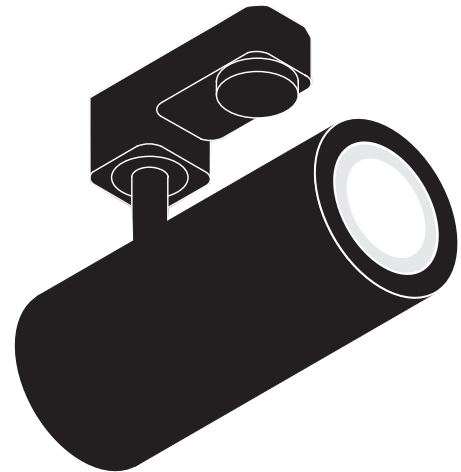
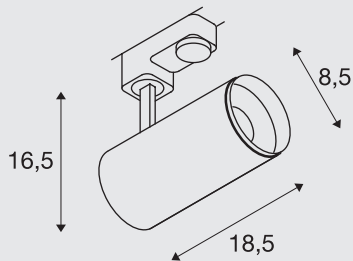

■ schwarz

### Hinweis:

Zierring auch in Weiß erhältlich



Zierring M

■ weiß

Art. Nr. 1006168

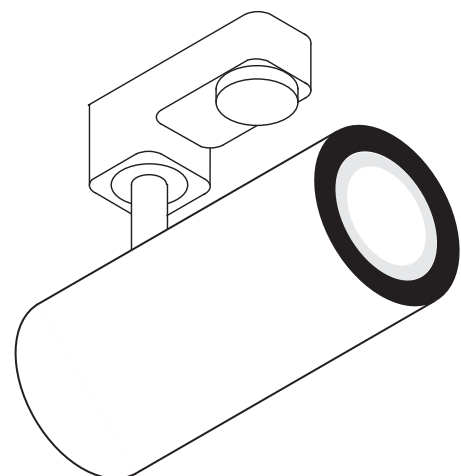

□ weiß





ART. NR.



	1925lm	24°	16	<b>1004170</b>
2700K	1935lm	36°	16	<b>1004171</b>
	1885lm	60°	22	<b>1004172</b>
	1955lm	24°	16	<b>1004178</b>
3000K	1970lm	36°	13	<b>1004179</b>
	1880lm	60°	22	<b>1004180</b>
	2125lm	24°	19	<b>1004186</b>
4000K	2120lm	36°	16	<b>1004187</b>
	2060lm	60°	25	<b>1004188</b>



	1925lm	24°	16	<b>1004458</b>
2700K	1935lm	36°	16	<b>1004459</b>
	1885lm	60°	22	<b>1004460</b>
	1955lm	24°	16	<b>1004466</b>
3000K	1970lm	36°	13	<b>1004467</b>
	1880lm	60°	22	<b>1004468</b>
	2125lm	24°	19	<b>1004474</b>
4000K	2120lm	36°	16	<b>1004475</b>
	2060lm	60°	25	<b>1004476</b>



	1925lm	24°	16	<b>1004174</b>
2700K	1935lm	36°	16	<b>1004175</b>
	1885lm	60°	22	<b>1004176</b>
	1955lm	24°	16	<b>1004182</b>
3000K	1970lm	36°	13	<b>1004183</b>
	1880lm	60°	22	<b>1004184</b>
	2125lm	24°	19	<b>1004190</b>
4000K	2120lm	36°	16	<b>1004191</b>
	2060lm	60°	25	<b>1004192</b>



	1925lm	24°	16	<b>1004462</b>
2700K	1935lm	36°	16	<b>1004463</b>
	1885lm	60°	22	<b>1004464</b>
	1955lm	24°	16	<b>1004470</b>
3000K	1970lm	36°	13	<b>1004471</b>
	1880lm	60°	22	<b>1004472</b>
	2125lm	24°	19	<b>1004478</b>
4000K	2120lm	36°	16	<b>1004479</b>
	2060lm	60°	25	<b>1004480</b>



# SLV NUMINOS® L



## 3Ph.

### Produktangaben:

220-240V ~50/60Hz | 700mA

Systemleistung: 28W

Material: Aluminium / Polycarbonat (PC)

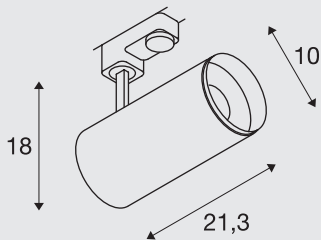

### Hinweis:

Zierring auch in Weiß erhältlich

Zierring L

■ weiß

Art. Nr. 1006169

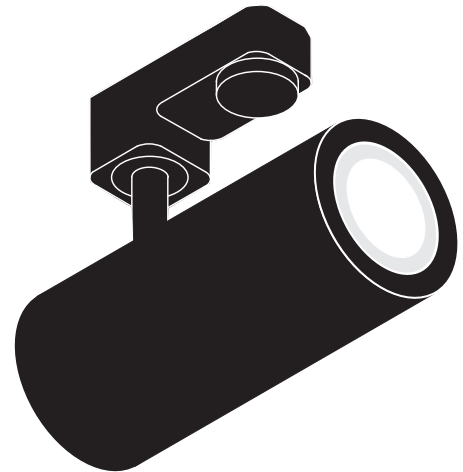

■ schwarz

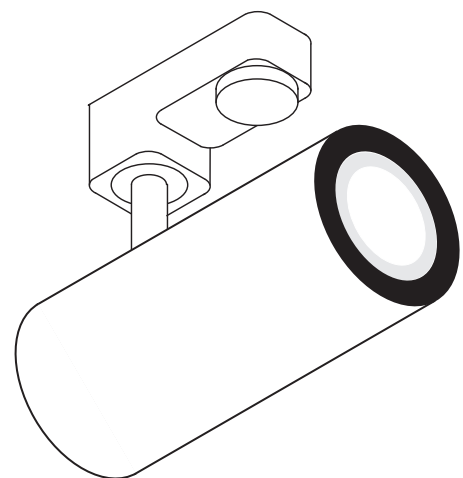

□ weiß



ART. NR.



	2440lm	24°	19	<b>1004266</b>
2700K	2400lm	36°	19	<b>1004267</b>
	2475lm	60°	22	<b>1004268</b>
	2430lm	24°	13	<b>1004274</b>
3000K	2340lm	36°	13	<b>1004275</b>
	2400lm	60°	22	<b>1004276</b>
	2675lm	24°	19	<b>1004282</b>
4000K	2620lm	36°	19	<b>1004283</b>
	2715lm	60°	22	<b>1004284</b>



	2440lm	24°	19	<b>1004554</b>
2700K	2400lm	36°	19	<b>1004555</b>
	2475lm	60°	22	<b>1004556</b>
	2430lm	24°	13	<b>1004562</b>
3000K	2340lm	36°	13	<b>1004563</b>
	2400lm	60°	22	<b>1004564</b>
	2675lm	24°	19	<b>1004570</b>
4000K	2620lm	36°	19	<b>1004571</b>
	2715lm	60°	22	<b>1004572</b>



	2440lm	24°	19	<b>1004270</b>
2700K	2400lm	36°	19	<b>1004271</b>
	2475lm	60°	22	<b>1004272</b>
	2430lm	24°	13	<b>1004278</b>
3000K	2340lm	36°	13	<b>1004279</b>
	2400lm	60°	22	<b>1004280</b>
	2675lm	24°	19	<b>1004286</b>
4000K	2620lm	36°	19	<b>1004287</b>
	2715lm	60°	22	<b>1004288</b>



	2440lm	24°	19	<b>1004558</b>
2700K	2400lm	36°	19	<b>1004559</b>
	2475lm	60°	22	<b>1004560</b>
	2430lm	24°	13	<b>1004566</b>
3000K	2340lm	36°	13	<b>1004567</b>
	2400lm	60°	22	<b>1004568</b>
	2675lm	24°	19	<b>1004574</b>
4000K	2620lm	36°	19	<b>1004575</b>
	2715lm	60°	22	<b>1004576</b>



# SLV NUMINOS® XL



## 3Ph.

### Produktangaben:

220-240V ~50/60Hz | 900mA

Systemleistung: 36W

Material: Aluminium / Polycarbonat (PC)

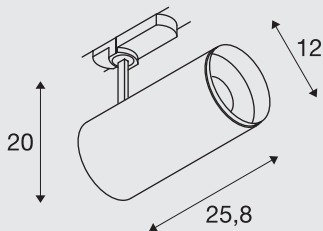

### Hinweis:

Zierring auch in Weiß erhältlich

Zierring XL

■ weiß

Art. Nr. 1006170

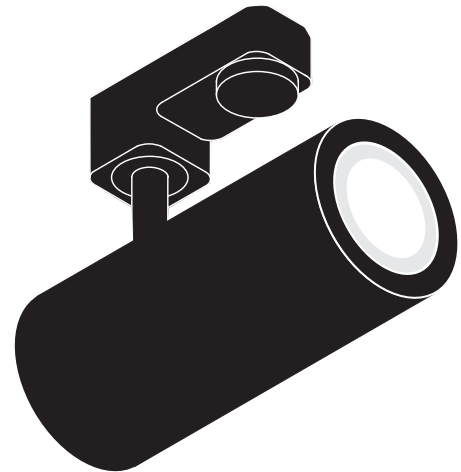

■ schwarz

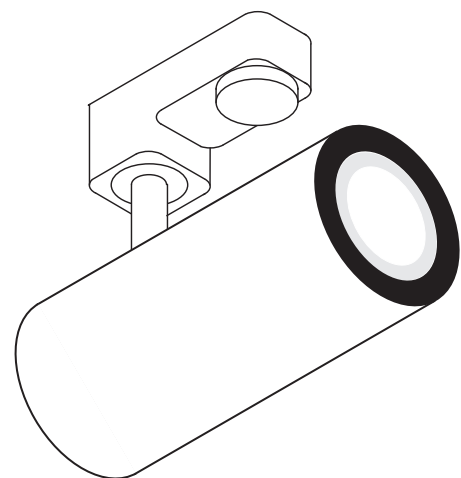

□ weiß



ART. NR.



	3290lm	24°	19	<b>1005723</b>
2700K	3250lm	36°	19	<b>1005724</b>
	2980lm	60°	25	<b>1005725</b>
	3530lm	24°	19	<b>1005729</b>
3000K	3490lm	36°	19	<b>1005730</b>
	3210lm	60°	25	<b>1005731</b>
	3800lm	24°	19	<b>1005735</b>
4000K	3760lm	36°	19	<b>1005736</b>
	3460lm	60°	25	<b>1005737</b>



	3290lm	24°	19	<b>1005795</b>
2700K	3250lm	36°	19	<b>1005796</b>
	2980lm	60°	25	<b>1005797</b>
	3530lm	24°	19	<b>1005801</b>
3000K	3490lm	36°	19	<b>1005802</b>
	3210lm	60°	25	<b>1005803</b>
	3800lm	24°	19	<b>1005807</b>
4000K	3760lm	36°	19	<b>1005808</b>
	3460lm	60°	25	<b>1005809</b>



	3290lm	24°	19	<b>1005726</b>
2700K	3250lm	36°	19	<b>1005727</b>
	2980lm	60°	25	<b>1005728</b>
	3530lm	24°	19	<b>1005732</b>
3000K	3490lm	36°	19	<b>1005733</b>
	3210lm	60°	25	<b>1005734</b>
	3800lm	24°	19	<b>1005738</b>
4000K	3760lm	36°	19	<b>1005739</b>
	3460lm	60°	25	<b>1005740</b>



	3290lm	24°	19	<b>1005798</b>
2700K	3250lm	36°	19	<b>1005799</b>
	2980lm	60°	25	<b>1005800</b>
	3530lm	24°	19	<b>1005804</b>
3000K	3490lm	36°	19	<b>1005805</b>
	3210lm	60°	25	<b>1005806</b>
	3800lm	24°	19	<b>1005810</b>
4000K	3760lm	36°	19	<b>1005811</b>
	3460lm	60°	25	<b>1005812</b>



# SLV NUMINOS® ZOOM M 3Ph.



## Produktangaben:

220-240V ~50/60Hz | 500mA

Systemleistung: 20W

Material: Aluminium / Polycarbonat (PC)

- Halbstreuwinkel einstellbar von 15°-60°.

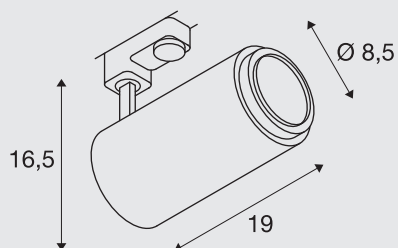
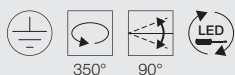

## Hinweis:

Zierring auch in Weiß erhältlich

Zierring M

■ weiß

Art. Nr. 1006168

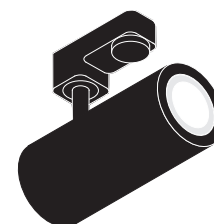

■ schwarz

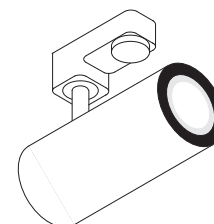

□ weiß







ART. NR.



2700K	680-1650lm	15°-60°	25	<b>1006108</b>
3000K	750-1800lm	15°-60°	25	<b>1006110</b>
4000K	780-1900lm	15°-60°	25	<b>1006112</b>



2700K	680-1650lm	15°-60°	25	<b>1006114</b>
3000K	750-1800lm	15°-60°	25	<b>1006116</b>
4000K	780-1900lm	15°-60°	25	<b>1006118</b>



2700K	680-1650lm	15°-60°	25	<b>1006109</b>
3000K	750-1800lm	15°-60°	25	<b>1006111</b>
4000K	780-1900lm	15°-60°	25	<b>1006113</b>



2700K	680-1650lm	15°-60°	25	<b>1006115</b>
3000K	750-1800lm	15°-60°	25	<b>1006117</b>
4000K	780-1900lm	15°-60°	25	<b>1006119</b>



# SLV NUMINOS® S



## CW

### Produktangaben:

220-240V ~50/60Hz | 250mA

Systemleistung: 11W

Material: Aluminium / Polycarbonat (PC)

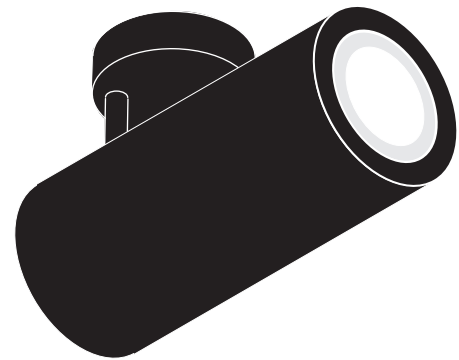
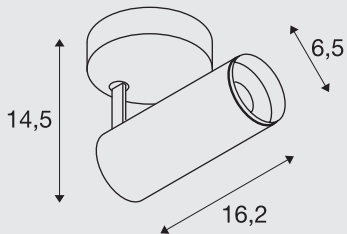

■ schwarz

### Hinweis:

Zierring auch in Weiß erhältlich



Zierring S

■ weiß

Art. Nr. 1006167

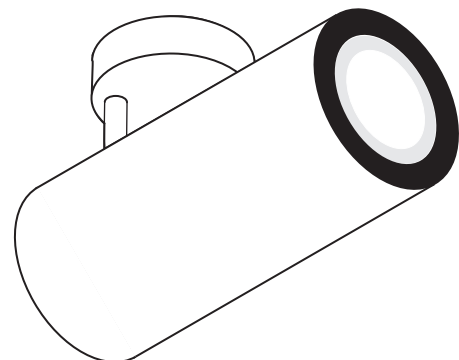

□ weiß



ART. NR.



	985lm	24°	16	<b>1004098</b>
2700K	985lm	36°	16	<b>1004099</b>
	980lm	60°	19	<b>1004100</b>
	1020lm	24°	13	<b>1004106</b>
3000K	1020lm	36°	13	<b>1004107</b>
	1020lm	60°	19	<b>1004108</b>
	1100lm	24°	16	<b>1004114</b>
4000K	1100lm	36°	16	<b>1004115</b>
	1100lm	60°	19	<b>1004116</b>



	985lm	24°	16	<b>1004386</b>
2700K	985lm	36°	16	<b>1004387</b>
	980lm	60°	19	<b>1004388</b>
	1020lm	24°	13	<b>1004394</b>
3000K	1020lm	36°	13	<b>1004395</b>
	1020lm	60°	19	<b>1004396</b>
	1100lm	24°	16	<b>1004402</b>
4000K	1100lm	36°	16	<b>1004403</b>
	1100lm	60°	19	<b>1004404</b>



	985lm	24°	16	<b>1004102</b>
2700K	985lm	36°	16	<b>1004103</b>
	980lm	60°	19	<b>1004104</b>
	1020lm	24°	13	<b>1004110</b>
3000K	1020lm	36°	13	<b>1004111</b>
	1020lm	60°	19	<b>1004112</b>
	1100lm	24°	16	<b>1004118</b>
4000K	1100lm	36°	16	<b>1004119</b>
	1100lm	60°	19	<b>1004120</b>



	985lm	24°	16	<b>1004390</b>
2700K	985lm	36°	16	<b>1004391</b>
	980lm	60°	19	<b>1004392</b>
	1020lm	24°	13	<b>1004398</b>
3000K	1020lm	36°	13	<b>1004399</b>
	1020lm	60°	19	<b>1004400</b>
	1100lm	24°	16	<b>1004406</b>
4000K	1100lm	36°	16	<b>1004407</b>
	1100lm	60°	19	<b>1004408</b>



# SLV NUMINOS® M



## CL

### Produktangaben:

220-240V ~50/60Hz | 500mA

Systemleistung: 20W

Material: Aluminium / Polycarbonat (PC)

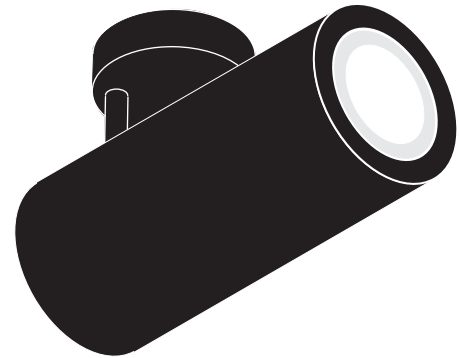
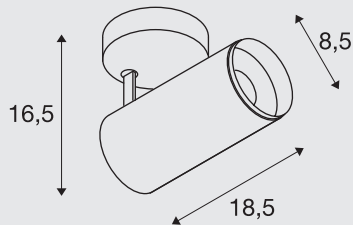

■ schwarz

### Hinweis:

Zierring auch in Weiß erhältlich



Zierring M

■ weiß

Art. Nr. 1006168

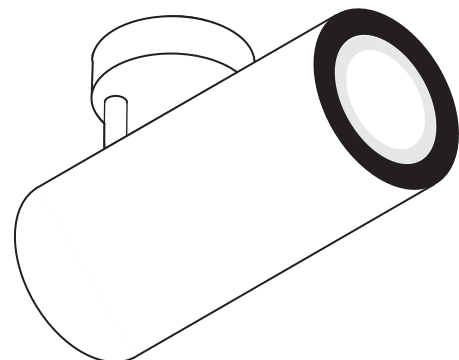

□ weiß



ART. NR.



	1925lm	24°	16	<b>1004194</b>
2700K	1935lm	36°	16	<b>1004195</b>
	1885lm	60°	22	<b>1004196</b>
	1955lm	24°	16	<b>1004202</b>
3000K	1970lm	36°	13	<b>1004203</b>
	1880lm	60°	22	<b>1004204</b>
	2125lm	24°	19	<b>1004210</b>
4000K	2120lm	36°	16	<b>1004211</b>
	2060lm	60°	25	<b>1004212</b>



	1925lm	24°	16	<b>1004482</b>
2700K	1935lm	36°	16	<b>1004483</b>
	1885lm	60°	22	<b>1004484</b>
	1955lm	24°	16	<b>1004490</b>
3000K	1970lm	36°	13	<b>1004491</b>
	1880lm	60°	22	<b>1004492</b>
	2125lm	24°	19	<b>1004498</b>
4000K	2120lm	36°	16	<b>1004499</b>
	2060lm	60°	25	<b>1004500</b>



	1925lm	24°	16	<b>1004198</b>
2700K	1935lm	36°	16	<b>1004199</b>
	1885lm	60°	22	<b>1004200</b>
	1955lm	24°	16	<b>1004206</b>
3000K	1970lm	36°	13	<b>1004207</b>
	1880lm	60°	22	<b>1004208</b>
	2125lm	24°	19	<b>1004214</b>
4000K	2120lm	36°	16	<b>1004215</b>
	2060lm	60°	25	<b>1004216</b>



	1925lm	24°	16	<b>1004486</b>
2700K	1935lm	36°	16	<b>1004487</b>
	1885lm	60°	22	<b>1004488</b>
	1955lm	24°	16	<b>1004494</b>
3000K	1970lm	36°	13	<b>1004495</b>
	1880lm	60°	22	<b>1004496</b>
	2125lm	24°	19	<b>1004502</b>
4000K	2120lm	36°	16	<b>1004503</b>
	2060lm	60°	25	<b>1004504</b>



# SLV NUMINOS® L



## CL

### Produktangaben:

220-240V ~50/60Hz | 700mA

Systemleistung: 28W

Material: Aluminium / Polycarbonat (PC)

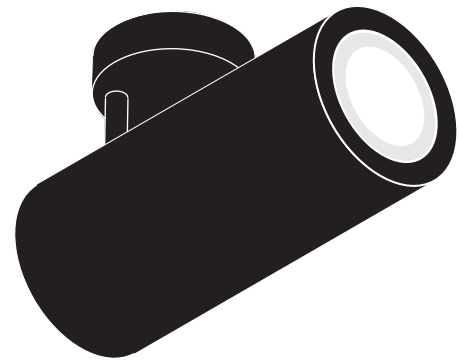
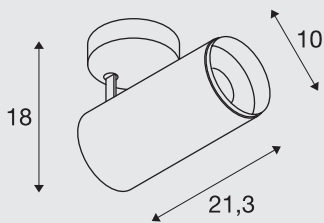

■ schwarz

### Hinweis:

Zierring auch in Weiß erhältlich



Zierring L

■ weiß

Art. Nr. 1006169

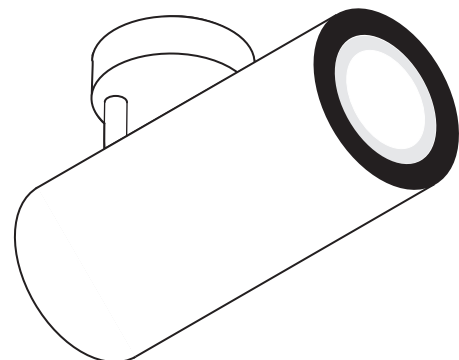

□ weiß





ART. NR.



	2440lm	24°	19	<b>1004290</b>
2700K	2400lm	36°	19	<b>1004291</b>
	2475lm	60°	22	<b>1004292</b>
	2430lm	24°	13	<b>1004298</b>
3000K	2340lm	36°	13	<b>1004299</b>
	2400lm	60°	22	<b>1004300</b>
	2675lm	24°	19	<b>1004306</b>
4000K	2620lm	36°	19	<b>1004307</b>
	2715lm	60°	22	<b>1004308</b>



	2440lm	24°	19	<b>1004578</b>
2700K	2400lm	36°	19	<b>1004579</b>
	2475lm	60°	22	<b>1004580</b>
	2430lm	24°	13	<b>1004586</b>
3000K	2340lm	36°	13	<b>1004587</b>
	2400lm	60°	22	<b>1004588</b>
	2675lm	24°	19	<b>1004594</b>
4000K	2620lm	36°	19	<b>1004595</b>
	2715lm	60°	22	<b>1004596</b>



	2440lm	24°	19	<b>1004294</b>
2700K	2400lm	36°	19	<b>1004295</b>
	2475lm	60°	22	<b>1004296</b>
	2430lm	24°	13	<b>1004302</b>
3000K	2340lm	36°	13	<b>1004303</b>
	2400lm	60°	22	<b>1004304</b>
	2675lm	24°	19	<b>1004310</b>
4000K	2620lm	36°	19	<b>1004311</b>
	2715lm	60°	22	<b>1004312</b>



	2440lm	24°	19	<b>1004582</b>
2700K	2400lm	36°	19	<b>1004583</b>
	2475lm	60°	22	<b>1004584</b>
	2430lm	24°	13	<b>1004590</b>
3000K	2340lm	36°	13	<b>1004591</b>
	2400lm	60°	22	<b>1004592</b>
	2675lm	24°	19	<b>1004598</b>
4000K	2620lm	36°	19	<b>1004599</b>
	2715lm	60°	22	<b>1004600</b>



# SLV NUMINOS® XL



## CL

### Produktangaben:

220-240V ~50/60Hz | 900mA

Systemleistung: 36W

Material: Aluminium / Polycarbonat (PC)

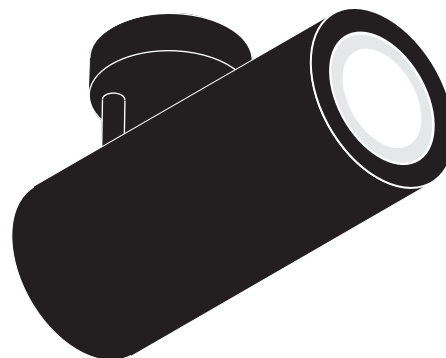
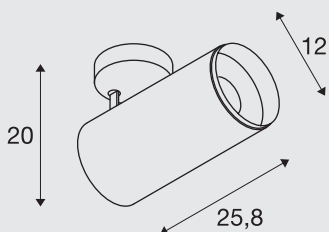

■ schwarz

### Hinweis:

Zierring auch in Weiß erhältlich



Zierring XL

■ weiß

Art. Nr. 1006170

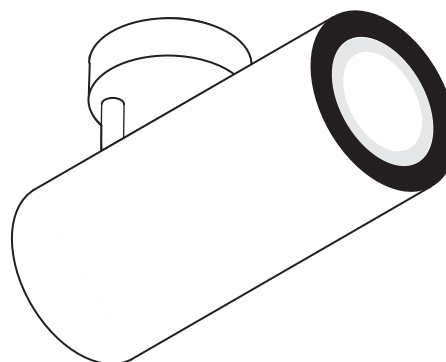

□ weiß



ART. NR.



	3290lm	24°	19	<b>1006083</b>
2700K	3250lm	36°	19	<b>1006084</b>
	2980lm	60°	25	<b>1006085</b>
	3530lm	24°	19	<b>1006089</b>
3000K	3490lm	36°	19	<b>1006090</b>
	3210lm	60°	25	<b>1006091</b>
	3800lm	24°	19	<b>1006095</b>
4000K	3760lm	36°	19	<b>1006096</b>
	3460lm	60°	25	<b>1006097</b>



	3290lm	24°	19	<b>1005741</b>
2700K	3250lm	36°	19	<b>1005742</b>
	2980lm	60°	25	<b>1005743</b>
	3530lm	24°	19	<b>1005747</b>
3000K	3490lm	36°	19	<b>1005748</b>
	3210lm	60°	25	<b>1005749</b>
	3800lm	24°	19	<b>1005753</b>
4000K	3760lm	36°	19	<b>1005754</b>
	3460lm	60°	25	<b>1005755</b>



	3290lm	24°	19	<b>1006086</b>
2700K	3250lm	36°	19	<b>1006087</b>
	2980lm	60°	25	<b>1006088</b>
	3530lm	24°	19	<b>1006092</b>
3000K	3490lm	36°	19	<b>1006093</b>
	3210lm	60°	25	<b>1006094</b>
	3800lm	24°	19	<b>1006098</b>
4000K	3760lm	36°	19	<b>1006099</b>
	3460lm	60°	25	<b>1006100</b>



	3290lm	24°	19	<b>1005744</b>
2700K	3250lm	36°	19	<b>1005745</b>
	2980lm	60°	25	<b>1005746</b>
	3530lm	24°	19	<b>1005750</b>
3000K	3490lm	36°	19	<b>1005751</b>
	3210lm	60°	25	<b>1005752</b>
	3800lm	24°	19	<b>1005756</b>
4000K	3760lm	36°	19	<b>1005757</b>
	3460lm	60°	25	<b>1005758</b>



# SLV NUMINOS® S



## CL

### Produktangaben:

220-240V ~50/60Hz | 250mA

Systemleistung: 11W

Material: Aluminium / Polycarbonat (PC)

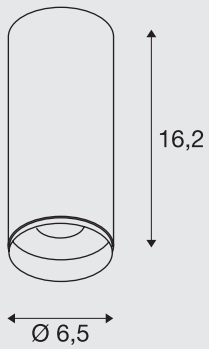

### Hinweis:

Zierring auch in Weiß erhältlich

Zierring S

■ weiß

Art. Nr. 1006167



■ schwarz

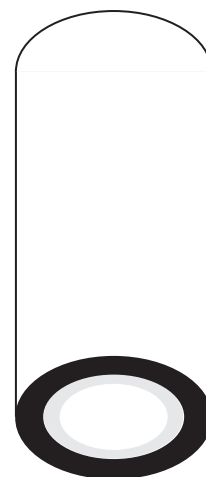

□ weiß



ART. NR.



	985lm	24°	16	<b>1004122</b>
2700K	985lm	36°	16	<b>1004123</b>
	980lm	60°	19	<b>1004124</b>
3000K	1020lm	24°	13	<b>1004130</b>
	1020lm	36°	13	<b>1004131</b>
	1020lm	60°	19	<b>1004132</b>
4000K	1100lm	24°	16	<b>1004138</b>
	1100lm	36°	16	<b>1004139</b>
	1100lm	60°	19	<b>1004140</b>



	985lm	24°	16	<b>1004410</b>
2700K	985lm	36°	16	<b>1004411</b>
	980lm	60°	19	<b>1004412</b>
3000K	1020lm	24°	13	<b>1004418</b>
	1020lm	36°	13	<b>1004419</b>
	1020lm	60°	19	<b>1004420</b>
4000K	1100lm	24°	16	<b>1004426</b>
	1100lm	36°	16	<b>1004427</b>
	1100lm	60°	19	<b>1004428</b>



	985lm	24°	16	<b>1004126</b>
2700K	985lm	36°	16	<b>1004127</b>
	980lm	60°	19	<b>1004128</b>
3000K	1020lm	24°	13	<b>1004134</b>
	1020lm	36°	13	<b>1004135</b>
	1020lm	60°	19	<b>1004136</b>
4000K	1100lm	24°	16	<b>1004142</b>
	1100lm	36°	16	<b>1004143</b>
	1100lm	60°	19	<b>1004144</b>



	985lm	24°	16	<b>1004414</b>
2700K	985lm	36°	16	<b>1004415</b>
	980lm	60°	19	<b>1004416</b>
3000K	1020lm	24°	13	<b>1004422</b>
	1020lm	36°	13	<b>1004423</b>
	1020lm	60°	19	<b>1004424</b>
4000K	1100lm	24°	16	<b>1004430</b>
	1100lm	36°	16	<b>1004431</b>
	1100lm	60°	19	<b>1004432</b>



# SLV NUMINOS® M



## CL

### Produktangaben:

220-240V ~50/60Hz | 500mA

Systemleistung: 20W

Material: Aluminium / Polycarbonat (PC)

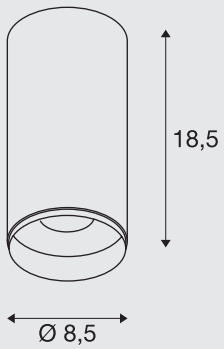

### Hinweis:

Zierring auch in Weiß erhältlich

Zierring M

■ weiß

Art. Nr. 1006168



■ schwarz

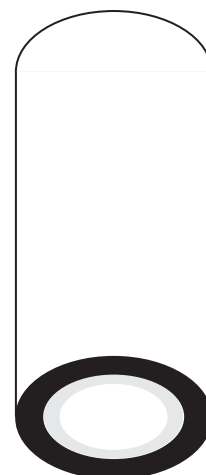

□ weiß





ART. NR.



	1925lm	24°	16	<b>1004218</b>
2700K	1935lm	36°	16	<b>1004219</b>
	1885lm	60°	22	<b>1004220</b>
	1955lm	24°	16	<b>1004226</b>
3000K	1970lm	36°	13	<b>1004227</b>
	1880lm	60°	22	<b>1004228</b>
	2125lm	24°	19	<b>1004234</b>
4000K	2120lm	36°	16	<b>1004235</b>
	2060lm	60°	25	<b>1004236</b>



	1925lm	24°	16	<b>1004506</b>
2700K	1935lm	36°	16	<b>1004507</b>
	1885lm	60°	22	<b>1004508</b>
	1955lm	24°	16	<b>1004514</b>
3000K	1970lm	36°	13	<b>1004515</b>
	1880lm	60°	22	<b>1004516</b>
	2125lm	24°	19	<b>1004522</b>
4000K	2120lm	36°	16	<b>1004523</b>
	2060lm	60°	25	<b>1004524</b>



	1925lm	24°	16	<b>1004222</b>
2700K	1935lm	36°	16	<b>1004223</b>
	1885lm	60°	22	<b>1004224</b>
	1955lm	24°	16	<b>1004230</b>
3000K	1970lm	36°	13	<b>1004231</b>
	1880lm	60°	22	<b>1004232</b>
	2125lm	24°	19	<b>1004238</b>
4000K	2120lm	36°	16	<b>1004239</b>
	2060lm	60°	25	<b>1004240</b>



	1925lm	24°	16	<b>1004510</b>
2700K	1935lm	36°	16	<b>1004511</b>
	1885lm	60°	22	<b>1004512</b>
	1955lm	24°	16	<b>1004518</b>
3000K	1970lm	36°	13	<b>1004519</b>
	1880lm	60°	22	<b>1004520</b>
	2125lm	24°	19	<b>1004526</b>
4000K	2120lm	36°	16	<b>1004527</b>
	2060lm	60°	25	<b>1004528</b>



# SLV NUMINOS® L



## CL

### Produktangaben:

220-240V ~50/60Hz | 700mA

Systemleistung: 28W

Material: Aluminium / Polycarbonat (PC)

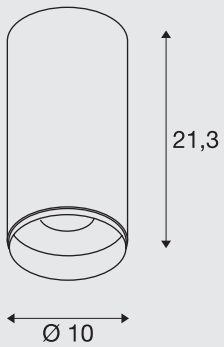

### Hinweis:

Zierring auch in Weiß erhältlich

Zierring L

■ weiß

Art. Nr. 1006169



■ schwarz

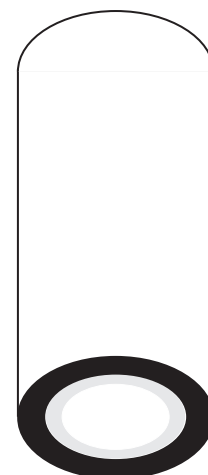

□ weiß



ART. NR.



	2440lm	24°	19	<b>1004314</b>
2700K	2400lm	36°	19	<b>1004315</b>
	2475lm	60°	22	<b>1004316</b>
	2430lm	24°	13	<b>1004322</b>
3000K	2340lm	36°	13	<b>1004323</b>
	2400lm	60°	22	<b>1004324</b>
	2675lm	24°	19	<b>1004330</b>
4000K	2620lm	36°	19	<b>1004331</b>
	2715lm	60°	22	<b>1004332</b>



	2440lm	24°	19	<b>1004602</b>
2700K	2400lm	36°	19	<b>1004603</b>
	2475lm	60°	22	<b>1004604</b>
	2430lm	24°	13	<b>1004610</b>
3000K	2340lm	36°	13	<b>1004611</b>
	2400lm	60°	22	<b>1004612</b>
	2675lm	24°	19	<b>1004618</b>
4000K	2620lm	36°	19	<b>1004619</b>
	2715lm	60°	22	<b>1004620</b>



	2440lm	24°	19	<b>1004318</b>
2700K	2400lm	36°	19	<b>1004319</b>
	2475lm	60°	22	<b>1004320</b>
	2430lm	24°	13	<b>1004326</b>
3000K	2340lm	36°	13	<b>1004327</b>
	2400lm	60°	22	<b>1004328</b>
	2675lm	24°	19	<b>1004334</b>
4000K	2620lm	36°	19	<b>1004335</b>
	2715lm	60°	22	<b>1004336</b>



	2440lm	24°	19	<b>1004606</b>
2700K	2400lm	36°	19	<b>1004607</b>
	2475lm	60°	22	<b>1004608</b>
	2430lm	24°	13	<b>1004614</b>
3000K	2340lm	36°	13	<b>1004615</b>
	2400lm	60°	22	<b>1004616</b>
	2675lm	24°	19	<b>1004622</b>
4000K	2620lm	36°	19	<b>1004623</b>
	2715lm	60°	22	<b>1004624</b>



# SLV NUMINOS® XL



## CL

### Produktangaben:

220-240V ~50/60Hz | 900mA

Systemleistung: 36W

Material: Aluminium / Polycarbonat (PC)

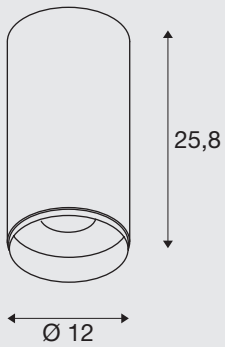

### Hinweis:

Zierring auch in Weiß erhältlich

Zierring XL

■ weiß

Art. Nr. 1006170



■ schwarz

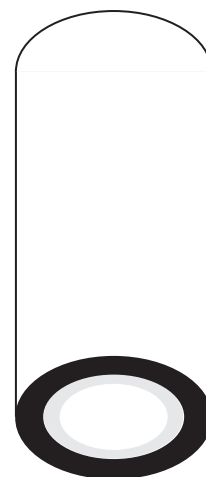

□ weiß



ART. NR.



	3290lm	24°	19	<b>1005687</b>
2700K	3250lm	36°	19	<b>1005688</b>
	2980lm	60°	25	<b>1005689</b>
	3530lm	24°	19	<b>1005693</b>
3000K	3490lm	36°	19	<b>1005694</b>
	3210lm	60°	25	<b>1005695</b>
4000K	3800lm	24°	19	<b>1005699</b>
	3760lm	36°	19	<b>1005700</b>
	3460lm	60°	25	<b>1005701</b>



	3290lm	24°	19	<b>1005759</b>
2700K	3250lm	36°	19	<b>1005760</b>
	2980lm	60°	25	<b>1005761</b>
3000K	3530lm	24°	19	<b>1005765</b>
	3490lm	36°	19	<b>1005766</b>
	3210lm	60°	25	<b>1005767</b>
4000K	3800lm	24°	19	<b>1005771</b>
	3760lm	36°	19	<b>1005772</b>
	3460lm	60°	25	<b>1005773</b>



	3290lm	24°	19	<b>1005690</b>
2700K	3250lm	36°	19	<b>1005691</b>
	2980lm	60°	25	<b>1005692</b>
	3530lm	24°	19	<b>1005696</b>
3000K	3490lm	36°	19	<b>1005697</b>
	3210lm	60°	25	<b>1005698</b>
4000K	3800lm	24°	19	<b>1005702</b>
	3760lm	36°	19	<b>1005703</b>
	3460lm	60°	25	<b>1005704</b>



	3290lm	24°	19	<b>1005762</b>
2700K	3250lm	36°	19	<b>1005763</b>
	2980lm	60°	25	<b>1005764</b>
	3530lm	24°	19	<b>1005768</b>
3000K	3490lm	36°	19	<b>1005769</b>
	3210lm	60°	25	<b>1005770</b>
4000K	3800lm	24°	19	<b>1005774</b>
	3760lm	36°	19	<b>1005775</b>
	3460lm	60°	25	<b>1005776</b>



# SLV NUMINOS® S



## PD

### Produktangaben:

220-240V ~50/60Hz | 250mA

Systemleistung: 11W

Material: Aluminium / Polycarbonat (PC)

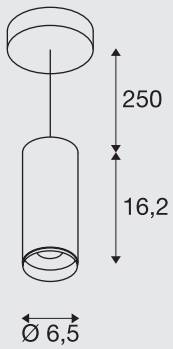
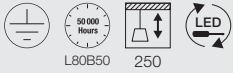

### Hinweis:

Zierring auch in Weiß erhältlich

Zierring S

■ weiß

Art. Nr. 1006167



■ schwarz

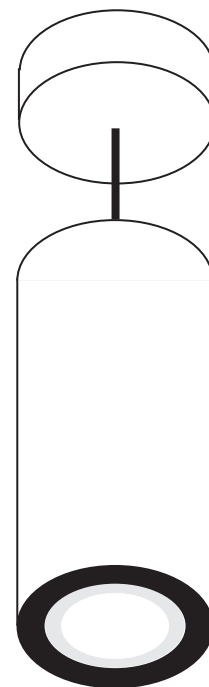

□ weiß





ART. NR.



	985lm	24°	16	<b>1004146</b>
2700K	985lm	36°	16	<b>1004147</b>
	980lm	60°	19	<b>1004148</b>
3000K	1020lm	24°	13	<b>1004154</b>
	1020lm	36°	13	<b>1004155</b>
	1020lm	60°	19	<b>1004156</b>
4000K	1100lm	24°	16	<b>1004162</b>
	1100lm	36°	16	<b>1004163</b>
	1100lm	60°	19	<b>1004164</b>



	985lm	24°	16	<b>1004434</b>
2700K	985lm	36°	16	<b>1004435</b>
	980lm	60°	19	<b>1004436</b>
3000K	1020lm	24°	13	<b>1004442</b>
	1020lm	36°	13	<b>1004443</b>
	1020lm	60°	19	<b>1004444</b>
4000K	1100lm	24°	16	<b>1004450</b>
	1100lm	36°	16	<b>1004451</b>
	1100lm	60°	19	<b>1004452</b>



	985lm	24°	16	<b>1004150</b>
2700K	985lm	36°	16	<b>1004151</b>
	980lm	60°	19	<b>1004152</b>
3000K	1020lm	24°	13	<b>1004158</b>
	1020lm	36°	13	<b>1004159</b>
	1020lm	60°	19	<b>1004160</b>
4000K	1100lm	24°	16	<b>1004166</b>
	1100lm	36°	16	<b>1004167</b>
	1100lm	60°	19	<b>1004168</b>



	985lm	24°	16	<b>1004438</b>
2700K	985lm	36°	16	<b>1004439</b>
	980lm	60°	19	<b>1004440</b>
3000K	1020lm	24°	13	<b>1004446</b>
	1020lm	36°	13	<b>1004447</b>
	1020lm	60°	19	<b>1004448</b>
4000K	1100lm	24°	16	<b>1004454</b>
	1100lm	36°	16	<b>1004455</b>
	1100lm	60°	19	<b>1004456</b>



# SLV NUMINOS® M



## PD

### Produktangaben:

220-240V ~50/60Hz | 500mA

Systemleistung: 20W

Material: Aluminium / Polycarbonat (PC)

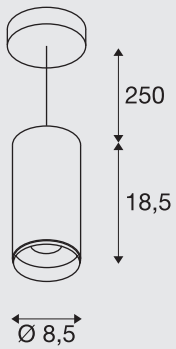
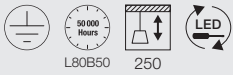

### Hinweis:

Zierring auch in Weiß erhältlich

Zierring M

■ weiß

Art. Nr. 1006168



■ schwarz

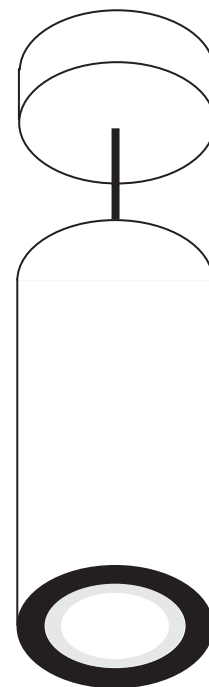

□ weiß



ART. NR.



	1925lm	24°	16	<b>1004242</b>
2700K	1935lm	36°	16	<b>1004243</b>
	1885lm	60°	22	<b>1004244</b>
	1955lm	24°	16	<b>1004250</b>
3000K	1970lm	36°	13	<b>1004251</b>
	1880lm	60°	22	<b>1004252</b>
	2125lm	24°	19	<b>1004258</b>
4000K	2120lm	36°	16	<b>1004259</b>
	2060lm	60°	25	<b>1004260</b>



	1925lm	24°	16	<b>1004530</b>
2700K	1935lm	36°	16	<b>1004531</b>
	1885lm	60°	22	<b>1004532</b>
	1955lm	24°	16	<b>1004538</b>
3000K	1970lm	36°	13	<b>1004539</b>
	1880lm	60°	22	<b>1004540</b>
	2125lm	24°	19	<b>1004546</b>
4000K	2120lm	36°	16	<b>1004547</b>
	2060lm	60°	25	<b>1004548</b>



	1925lm	24°	16	<b>1004246</b>
2700K	1935lm	36°	16	<b>1004247</b>
	1885lm	60°	22	<b>1004248</b>
	1955lm	24°	16	<b>1004254</b>
3000K	1970lm	36°	13	<b>1004255</b>
	1880lm	60°	22	<b>1004256</b>
	2125lm	24°	19	<b>1004262</b>
4000K	2120lm	36°	16	<b>1004263</b>
	2060lm	60°	25	<b>1004264</b>



	1925lm	24°	16	<b>1004534</b>
2700K	1935lm	36°	16	<b>1004535</b>
	1885lm	60°	22	<b>1004536</b>
	1955lm	24°	16	<b>1004542</b>
3000K	1970lm	36°	13	<b>1004543</b>
	1880lm	60°	22	<b>1004544</b>
	2125lm	24°	19	<b>1004550</b>
4000K	2120lm	36°	16	<b>1004551</b>
	2060lm	60°	25	<b>1004552</b>



# SLV NUMINOS® L



## PD

### Produktangaben:

220-240V ~50/60Hz| 700mA

Systemleistung: 28W

Material: Aluminium / Polycarbonat (PC)

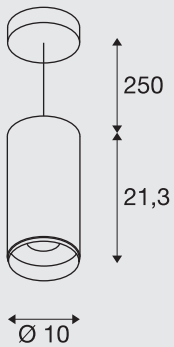
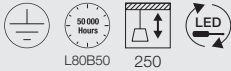

### Hinweis:

Zierring auch in Weiß erhältlich

Zierring L

■ weiß

Art. Nr. 1006169



■ schwarz

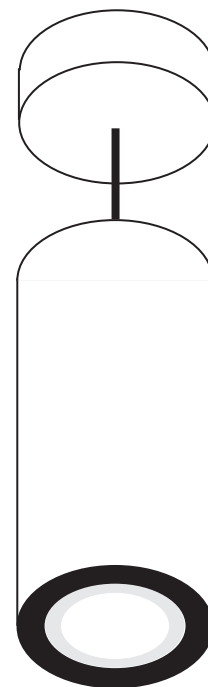

□ weiß



ART. NR.



	2440lm	24°	19	<b>1004338</b>
2700K	2400lm	36°	19	<b>1004339</b>
	2475lm	60°	22	<b>1004340</b>
	2430lm	24°	13	<b>1004346</b>
3000K	2340lm	36°	13	<b>1004347</b>
	2400lm	60°	22	<b>1004348</b>
	2675lm	24°	19	<b>1004354</b>
4000K	2620lm	36°	19	<b>1004355</b>
	2715lm	60°	22	<b>1004356</b>



	2440lm	24°	19	<b>1004626</b>
2700K	2400lm	36°	19	<b>1004627</b>
	2475lm	60°	22	<b>1004628</b>
	2430lm	24°	13	<b>1004634</b>
3000K	2340lm	36°	13	<b>1004635</b>
	2400lm	60°	22	<b>1004636</b>
	2675lm	24°	19	<b>1004642</b>
4000K	2620lm	36°	19	<b>1004643</b>
	2715lm	60°	22	<b>1004644</b>



	2440lm	24°	19	<b>1004342</b>
2700K	2400lm	36°	19	<b>1004343</b>
	2475lm	60°	22	<b>1004344</b>
	2430lm	24°	13	<b>1004350</b>
3000K	2340lm	36°	13	<b>1004351</b>
	2400lm	60°	22	<b>1004352</b>
	2675lm	24°	19	<b>1004358</b>
4000K	2620lm	36°	19	<b>1004359</b>
	2715lm	60°	22	<b>1004360</b>



	2440lm	24°	19	<b>1004630</b>
2700K	2400lm	36°	19	<b>1004631</b>
	2475lm	60°	22	<b>1004632</b>
	2430lm	24°	13	<b>1004638</b>
3000K	2340lm	36°	13	<b>1004639</b>
	2400lm	60°	22	<b>1004640</b>
	2675lm	24°	19	<b>1004646</b>
4000K	2620lm	36°	19	<b>1004647</b>
	2715lm	60°	22	<b>1004648</b>



# SLV NUMINOS® XL



## PD

### Produktangaben:

220-240V ~50/60Hz | 900mA

Systemleistung: 36W

Material: Aluminium / Polycarbonat (PC)

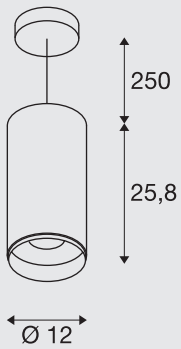
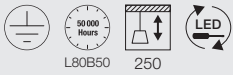

### Hinweis:

Zierring auch in Weiß erhältlich

Zierring XL

■ weiß

Art. Nr. 1006170



■ schwarz

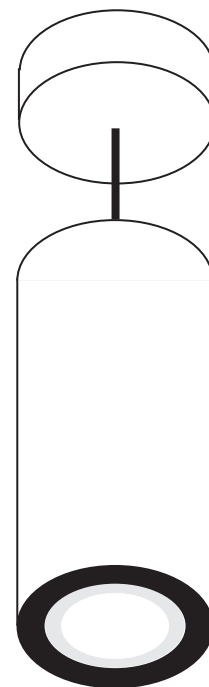

□ weiß



ART. NR.



	3290lm	24°	19	<b>1005705</b>
2700K	3250lm	36°	19	<b>1005706</b>
	2980lm	60°	25	<b>1005707</b>
	3530lm	24°	19	<b>1005711</b>
3000K	3490lm	36°	19	<b>1005712</b>
	3210lm	60°	25	<b>1005713</b>
	3800lm	24°	19	<b>1005717</b>
4000K	3760lm	36°	19	<b>1005718</b>
	3460lm	60°	25	<b>1005719</b>



	3290lm	24°	19	<b>1005777</b>
2700K	3250lm	36°	19	<b>1005778</b>
	2980lm	60°	25	<b>1005779</b>
	3530lm	24°	19	<b>1005783</b>
3000K	3490lm	36°	19	<b>1005784</b>
	3210lm	60°	25	<b>1005785</b>
	3800lm	24°	19	<b>1005789</b>
4000K	3760lm	36°	19	<b>1005790</b>
	3460lm	60°	25	<b>1005791</b>



	3290lm	24°	19	<b>1005708</b>
2700K	3250lm	36°	19	<b>1005709</b>
	2980lm	60°	25	<b>1005710</b>
	3530lm	24°	19	<b>1005714</b>
3000K	3490lm	36°	19	<b>1005715</b>
	3210lm	60°	25	<b>1005716</b>
	3800lm	24°	19	<b>1005720</b>
4000K	3760lm	36°	19	<b>1005721</b>
	3460lm	60°	25	<b>1005722</b>



	3290lm	24°	19	<b>1005780</b>
2700K	3250lm	36°	19	<b>1005781</b>
	2980lm	60°	25	<b>1005782</b>
	3530lm	24°	19	<b>1005786</b>
3000K	3490lm	36°	19	<b>1005787</b>
	3210lm	60°	25	<b>1005788</b>
	3800lm	24°	19	<b>1005792</b>
4000K	3760lm	36°	19	<b>1005793</b>
	3460lm	60°	25	<b>1005794</b>







---

Wer ein Projekt mit SLV NUMINOS® Downlights oder Spots verwirklicht hat, kann sich beruhigt zurücklehnen. Denn durch die Qualität der verbauten LED-Module und Treiber sind Langlebigkeit und Lichtqualität garantiert. Wann starten Sie Ihr Projekt mit dem SLV NUMINOS® Leuchtensystem?

# SYMBOLERKLÄRUNG



## Dimmbar mit ...

- C = Phasenabschnittsdimmer
- Dali = Dali Bussystem

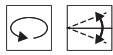

## Dreh- und Schwenkbarkeit in Grad:

- Drehbereich
- Schwenkbereich



## Der Halbstreuwinkel

beschreibt den Ausstrahlungswinkel in Grad. Je kleiner der Winkel desto stärker wird das Licht gebündelt.



## Netzkabellänge in cm



## Pendelkabellänge in cm



## Leuchten mit eingebauten LEDs

Die Lichtquelle dieser Leuchte darf nur vom Hersteller oder einem von ihm beauftragten Servicetechniker ersetzt werden.



## Der Lichtstromerhalt

Beschreibt um wie viel der Lichtstrom einer LED im angegebenen Zeitraum abnimmt.



## UGR = Unified Glare Rating

Je niedriger der UGR-Wert, desto geringer die psychologische Blendung.



## Farbtemperatur



## Lumen



## Steuerung



## Schutzklassen

- Schutzklasse I / Schutzleiter
- Schutzklasse II / Schutz durch doppelte oder verstärkte Isolierung
- Schutzklasse III / Schutz durch Kleinspannung



Der **IK-Stoßfestigkeitsgrad** ist ein Maß für die Widerstandsfähigkeit von Gehäusen elektrischer Betriebsmittel gegen mechanische Beanspruchung, insbesondere Stoßbeanspruchung.



## IP-Schutzart

Gibt die Eignung elektrischer Betriebsmittel für verschiedene Umgebungsbedingungen an.



## Unabhängiger Konverter

(Betriebsgerät auch zur Verwendung außerhalb von Leuchten)



## Kurzschlussfestes Sicherheitsbetriebsgerät



- Einsatz **ausschließlich** für Innenräume
- **Ungeeignet** für die Anwendung in Innenräumen



Kennzeichnet Produkte mit **eingebauten LEDs**



Kennzeichnet Leuchten aus einer **Leuchtenfamilie**



Ihren optionalen Treiber (On/Off, Phasendimmung, DALI) und passende Diffusoren können Sie über die **Farbkodierung** ganz einfach hinzufügen.

### Bitte beachten Sie:

Ein großer Teil der in diesem Katalog vorgestellten Produkte ist durch Warenzeichen, Geschmacksmuster, Gebrauchsmuster oder Patente geschützt. Ein Verstoß gegen diese Schutzrechte oder eine Verwendung von Text- und Layoutgestaltung sowie urheberrechtlich geschützten Bildern ohne unsere Genehmigung wird gerichtlich verfolgt. Die in diesem Katalog enthaltenen Abbildungen und Angaben dienen nur der Veranschaulichung und sind unverbindlich in Farbe, Form, Ausführung und technischen Daten. Bei sämtlichen Produktbeschreibungen/-angaben bleiben Änderungen und Irrtümer daher vorbehalten.

Alle Produkte unseres Sortiments unterliegen einer strengen Qualitätssicherung und erfüllen die allgemein gültigen Normen. Dieser Katalog beinhaltet ein allgemeines Sortiment und ist nicht landesspezifisch ausgelegt. Etwaige Abweichungen von landesspezifischen Vorgaben sind vor der Bestellung zu klären. SLV haftet nicht für gegebenenfalls abweichende technische Normen. Alle Gewichts- und Längenangaben sind in kg bzw. in cm angegeben, sofern nicht anders bezeichnet. Technische Änderungen vorbehalten!

Die Präsentation unserer Leuchten mit realistischen und beispielhaften Anwendungsfotos wird ermöglicht durch das freundliche Entgegenkommen und die Zustimmung der Eigentümer oder Gestalter der jeweils vordergründig in den Bildern zu sehenden Umgebungen. All jenen, die durch ihr Einverständnis zur Entstehung und Verwendung unserer Fotos beigetragen haben, sei an dieser Stelle nochmals herzlich gedankt!

Unser gesamtes Sortiment finden Sie auf unserer Internetseite [KS-Licht.de](http://KS-Licht.de) und im aktuellen Katalog BIG WHITE® 2022.

**Bildnachweise**  
SLV GmbH  
[www.gettyimages.de](http://www.gettyimages.de)

# Allgemeine Geschäftsbedingungen

Für alle gegenseitigen Ansprüche aus und im Zusammenhang mit einem Vertragsabschluss zwischen **gewerblich tätigen Kunden oder juristischen Personen** und KS Licht- und Elektrotechnik GmbH gelten unsere Allgemeinen Geschäftsbedingungen (AGB) in ihrer zum Zeitpunkt des jeweiligen Vertragsabschlusses gültigen Fassung. Es gilt deutsches Recht!

## Allgemeine Geschäftsbedingungen für Privatkunden

### 1. Geltungsbereich

Für alle Bestellungen über unseren Online-Shop gelten die nachfolgenden AGB. Unser Online-Shop richtet sich ausschließlich an Verbraucher. Verbraucher ist jede natürliche Person, die ein Rechtsgeschäft zu Zwecken abschließt, die überwiegend weder ihrer gewerblichen noch ihrer selbständigen beruflichen Tätigkeit zugerechnet werden können. Unternehmer ist eine natürliche oder juristische Person oder eine rechtsfähige Personengesellschaft, die bei Abschluss eines Rechtsgeschäfts in Ausübung ihrer gewerblichen oder selbständigen beruflichen Tätigkeit handelt.

### 2. Vertragspartner, Vertragsschluss, Korrekturmöglichkeiten

Der Kaufvertrag kommt zustande mit KS Licht- und Elektrotechnik GmbH.

Mit Einstellung der Produkte in den Online-Shop geben wir ein verbindliches Angebot zum Vertragsschluss über diese Artikel ab. Sie können unsere Produkte zunächst unverbindlich in den Warenkorb legen und Ihre Eingaben vor Absenden Ihrer verbindlichen Bestellung jederzeit korrigieren, indem Sie die hierfür im Bestellablauf vorgesehenen und erläuterten Korrekturmöglichkeiten nutzen. Der Vertrag kommt zustande, indem Sie durch Anklicken des Bestellbuttons das Angebot über die im Warenkorb enthaltenen Waren annehmen. Unmittelbar nach dem Absenden der Bestellung erhalten Sie noch einmal eine Bestätigung per E-Mail.

### 3. Vertragssprache, Vertragstextspeicherung

Die für den Vertragsschluss zur Verfügung stehende(n) Sprache(n): Deutsch, Englisch. Wir speichern den Vertragstext und senden Ihnen die Bestelldaten und unsere AGB in Textform zu. Den Vertragstext können Sie in unserem Kunden-Login einsehen.

### 4. Lieferbedingungen

Zuzüglich zu den angegebenen Produktpreisen können noch Versandkosten anfallen. Nähere Bestimmungen zu ggf. anfallenden Versandkosten erfahren Sie bei den Angeboten.

Sie haben grundsätzlich die Möglichkeit der Abholung bei KS Licht- und Elektrotechnik GmbH, Manderscheidtstr. 8 C, 45141 Essen, Deutschland zu den nachfolgend angegebenen Geschäftszeiten: Mo. - Do. 8.30-16.00 Uhr und Fr. 8.30-15.00 Uhr

### 5. Bezahlung

In unserem Shop stehen Ihnen grundsätzlich die folgenden Zahlungsarten zur Verfügung:

#### Vorkasse

Bei Auswahl der Zahlungsart Vorkasse nennen wir Ihnen unsere Bankverbindung in separater E-Mail und liefern die Ware nach Zahlungseingang.

#### Kreditkarte

Im Bestellprozess geben Sie Ihre Kreditkartendaten an. Ihre Karte wird unmittelbar nach Abgabe der Bestellung belastet.

#### PayPal, PayPal Express

Um den Rechnungsbetrag über den Zahlungsdienstleister PayPal (Europe) S.à r.l. et Cie, S.C.A, 22-24 Boulevard Royal, L-2449 Luxembourg („PayPal“) bezahlen zu können, müssen Sie bei PayPal registriert sein, sich mit Ihren Zugangsdaten legitimieren und die Zahlungsanweisung bestätigen. Die Zahlungsanweisung wird durch PayPal unmittelbar nach Abgabe der Bestellung durchgeführt. Weitere Hinweise erhalten Sie im Bestellvorgang.

PayPal kann registrierten und nach eigenen Kriterien ausgewählten PayPal-Kunden weitere Zahlungsmodalitäten im Kundenkonto anbieten. Auf das Anbieten dieser Modalitäten haben wir allerdings keinen Einfluss; weitere individuell angebotene Zahlungsmodalitäten betreffen Ihr Rechtsverhältnis mit PayPal. Weitere Informationen hierzu finden Sie in Ihrem PayPal-Konto.

#### PayPal

In Zusammenarbeit mit dem Zahlungsdienstleister PayPal (Europe) S.à r.l. et Cie, S.C.A, 22-24 Boulevard Royal, L-2449 Luxembourg („PayPal“) bieten wir Ihnen die nachfolgenden Zahlungsoptionen als PayPal Services an. Sofern nachfolgend nichts anderes geregelt ist, setzt die Zahlung über PayPal Plus keine Registrierung bei PayPal voraus. Weitere Hinweise erhalten Sie bei der jeweiligen Zahlungsoption und im Bestellvorgang.

#### PayPal

Um den Rechnungsbetrag über die Zahlungsoption PayPal bezahlen zu können, müssen Sie bei PayPal registriert sein, sich mit Ihren Zugangsdaten legitimieren und die Zahlungsanweisung bestätigen. Die Zahlungsanweisung wird durch PayPal unmittelbar nach Abgabe der Bestellung durchgeführt.

PayPal kann registrierten und nach eigenen Kriterien ausgewählten PayPal-Kunden weitere Zahlungsmodalitäten im Kundenkonto anbieten. Auf das Anbieten dieser Modalitäten haben wir allerdings keinen Einfluss; weitere individuell angebotene Zahlungsmodalitäten betreffen Ihr Rechtsverhältnis mit PayPal. Weitere Informationen hierzu finden Sie in Ihrem PayPal-Konto.

#### Kreditkarte über PayPal

Ihre Karte wird durch PayPal nach Versendung der Ware belastet.

#### Lastschrift über PayPal

Die Zahlung per Lastschrift über PayPal setzt eine Adress- und Bonitätsprüfung voraus und erfolgt direkt an PayPal. Mit Bestätigung der Zahlungsanweisung erteilen Sie PayPal ein Lastschriftmandat. Über das Datum der Kontobelastung werden Sie von PayPal informiert (sog. Prenotification). Die Kontobelastung erfolgt vor Versendung der Ware.

#### Kauf auf Rechnung über PayPal

Der Kauf auf Rechnung über PayPal setzt eine Adress- und Bonitätsprüfung voraus und erfolgt direkt an PayPal.

#### giropay / paydirekt

In Kooperation mit dem Zahlungsdienstleister paydirekt GmbH, Stephanstr. 14-16, 60313 Frankfurt a. M („giropay“ oder „paydirekt“) bieten wir die Zahlungsarten giropay und paydirekt an.

#### giropay

Um den Rechnungsbetrag über giropay bezahlen zu können, müssen Sie über ein für Online-Banking freigeschaltetes Bankkonto verfügen, sich entsprechend legitimieren und die Zahlungsanweisung bestätigen. Ihr Konto wird unmittelbar nach Abgabe der Bestellung belastet. Weitere Hinweise erhalten Sie im Bestellvorgang.

#### paydirekt

Um den Rechnungsbetrag über paydirekt bezahlen zu können, müssen Sie über ein für Online-Banking freigeschaltetes Bankkonto verfügen, bei paydirekt registriert sein, sich mit Ihren Zugangsdaten legitimieren und die Zahlungsanweisung bestätigen.

#### Barzahlung bei Abholung

Sie zahlen den Rechnungsbetrag bei der Abholung bar.

### 6. Eigentumsvorbehalt

Die Ware bleibt bis zur vollständigen Bezahlung unser Eigentum.

### 7. Transportschäden

Werden Waren mit offensichtlichen Transportschäden angeliefert, so reklamieren Sie solche Fehler bitte möglichst sofort beim Zusteller und nehmen Sie bitte unverzüglich Kontakt zu uns auf. Die Versäumung einer Reklamation oder Kontaktaufnahme hat für Ihre gesetzlichen Ansprüche und deren Durchsetzung, insbesondere Ihre Gewährleistungsrechte, keinerlei Konsequenzen. Sie helfen uns aber, unsere eigenen Ansprüche gegenüber dem Frachtführer bzw. der Transportversicherung geltend machen zu können.

### 8. Gewährleistung und Garantien

#### 8.1 Mängelhaftungsrecht

Es gilt das gesetzliche Mängelhaftungsrecht.

#### 8.2 Garantien und Kundendienst

Informationen zu gegebenenfalls geltenden zusätzlichen Garantien und deren genaue Bedingungen finden Sie jeweils beim Produkt und auf besonderen Informationsseiten im Online-Shop.

### 9. Verhaltenskodex

Folgenden Verhaltenskodizes haben wir uns unterworfen:

Trusted Shops ([https://www.trustedshops.com/tsdocument/TS\\_QUALITY\\_CRITERIA\\_de.pdf](https://www.trustedshops.com/tsdocument/TS_QUALITY_CRITERIA_de.pdf))

### 10. Streitbeilegung

Die Europäische Kommission stellt eine Plattform zur Online-Streitbeilegung (OS) bereit, die Sie hier finden. Wir sind bereit, an einem außergerichtlichen Schlichtungsverfahren vor einer Verbraucherschlichtungsstelle teilzunehmen.

Zuständig ist die Universalschlichtungsstelle des Bundes am Zentrum für Schlichtung e.V., Straßburger Straße 8, 77694 Kehl am Rhein, [www.verbraucher-schlichter.de](http://www.verbraucher-schlichter.de).

AGB erstellt mit dem Trusted Shops Rechtstexter

(02.02.2023)

## KS Licht- u. Elektrotechnik GmbH - für Sie vor Ort in Essen!



Link zum Multi-Brand Leuchten Onlineshop  
unter [www.KS-Licht.de](http://www.KS-Licht.de)

Nutzen Sie unseren KS Multi-BrandLeuchten Onlineshop unter [www.KS-Licht.de](http://www.KS-Licht.de) und profitieren Sie von folgenden Vorteilen und Funktionen:

- Vollsortiment ausgewählter Artikel für alle Anwendungen
- Hochmoderne, innovative LED Technik
- Energie- und kostensparende Beleuchtungslösungen
- Modernes Design
- Aktuelle Sonderangebote und Neuheiten
- Hohe Warenverfügbarkeit mit Onlineprüfung
- Schnelle Lieferung
- Schnellbestellformular zur schnellen Erfassung Ihres Auftrages
- Alle Kataloge zum Downloaden oder als Online-Blätterkatalog mit Produktlinks
- Einfache Produktsuche durch detaillierte Filterfunktionen
- Passende Produktempfehlungen für Leuchtmittel, Zubehör, Treiber, EVGs u. ä.
- Anzeige von Alternativprodukten und Produktfamilien/Varianten
- Onlinechat mit unseren Beratern für Ihre Fragen
- Restpostenangebote zu Tiefstpreisen

---

Die Lieferung erfolgt innerhalb Deutschland von unserem Lager frei Haus ab 79,00 EUR Bestellwert. Privatkunden erhalten bei Onlinebestellungen ein freiwilliges Rückgaberecht von 30 Tagen. Bitte beachten Sie unsere **TOP-Angebote**.

Für allgemeine Fragen, Lichtplanungen oder technische Details steht Ihnen unsere Verkaufsabteilung gerne zur Verfügung.

Weitere Informationen zu unserem Unternehmen und den vielen kostenfreien KS-Serviceleistungen erhalten Sie auf unserer Webseite [www.KS-Germany.com](http://www.KS-Germany.com).

### Öffnungszeiten:

Montag - Donnerstag      durchgehend von 08.00 Uhr bis 16.30 Uhr  
Freitag                      durchgehend von 08.00 Uhr bis 15.00 Uhr

**KS Licht- u. Elektrotechnik GmbH, Manderscheidtstr. 8c, 45141 Essen**



KS Licht- u. Elektrotechnik GmbH  
Manderscheidstr. 8c  
45141 Essen

Tel.: +49 (0)201-89924-0  
Fax: +49 (0)201-89924-124

Kostenlose Bestell-Hotline:  
**0800-KSLICHT** (0800-5754248)

Internet: [www.KS-Germany.com](http://www.KS-Germany.com)  
Email: [Verkauf@KS-Germany.com](mailto:Verkauf@KS-Germany.com)