

+SLV Profishop
EXPERIENCE LIGHT

powered by



BIG WHITE[®]

OUTDOOR 2026



+SLV
EXPERIENCE LIGHT



KS Profishop for SLV lighting: your reliable partner for SLV products for more than 30 year

PICK-UP CENTRE IN ESSEN

For over 30 years, KS Licht- und Elektrotechnik GmbH has been complementing SLV's products and services with a wide range of services. We maintain a collection centre for SLV products in the heart of the Ruhr area, where you can collect goods ordered from us at short notice.



EXPERIENCE SLV LIGHTS LIVE

We present a wide selection of SLV luminaires in our 300 m² showroom. Our professionally trained consultants and lighting designers are on hand to advise you personally. You can also use our showroom to demonstrate the functionality and effect of our luminaires to your customers. See the quality of our outdoor luminaires for yourself in our outdoor showroom.



FREE LIGHTING DESIGN

We work with you to develop practical lighting solutions tailored to your needs. Whether for business premises, sales rooms or private settings, our lighting designers always have the right concepts for a needs-based and energy-efficient solution. We would be happy to calculate the payback period for your new, energy-saving LED lighting.



KS MULTI-BRAND LIGHTING ONLINE SHOP

In our online business shop at www.profishop.online, you will find every-thing you need to support you in your daily work:

- Current special offers and new products
- Online availability check
- Find and order all spare parts conveniently
- Quick order form
- All catalogues available for download or as flip-through catalogues with product links
- Tender texts, light distribution curves/LDT plug-ins and quick calculation tables
- Configurators for luminaire systems



KS Licht- u. Elektrotechnik GmbH
Manderscheidstr. 8c
45141 Essen

Tel.: 0201-89924 - 0
Fax: 0201-899 24 - 124

Onlineshop: www.profishop.online
Internet: www.KS-Germany.com
Email: Verkauf@KS-Germany.com



Visit us on site or give us a call:
Monday - Thursday Continuously from 8 a.m. to 4.30 p.m.
Friday Continuously from 8 a.m. to 3 p.m.

Scan the link to our quick order form and receive up-to-date information on product availability!



www.profishop.online/quick-order-form

OUTDOOR

	Mobile lights and floor lamps	004
	Spotlights	119
	Ceiling lights	141
	Wall and ceiling lights	155
	Recessed lights	265
	Recessed floor lights	275

ACCESSORIES

	Lamps	315
	Accessory parts	327



LED
GRID SUN | 007



LED
GRID CUBE | 007



LED
ADEGAN | 009



LED
VINOLINA ONE | 011



LED
VINOLINA | 011



LED
VINOLINA TWO | 013



LED
TAHA | 015



SECKET
TUBE 32 | 017



SECKET
S-TUBE 75 | 017



SECKET
T-TUBE 70 | 019



SECKET
PHOTONI CYL | 021



SECKET
PHOTONI | 023



LED
S-CUBE | 024



LED
R-CUBE | 025



LED
I-RING 65 | 026



LED
LID I | 027



LED
QUAD PRO | 029

NEW



LED
M-POL | 030-039



LED
CONCRETE | 042-043

NEW



SECKET
CONCRETO | 045



LED
RASTERLYS 70 | 047

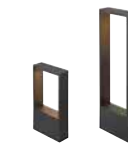

LED
FLATT II | 049

NEW



LED
FLATT | 050-051



LED
ESKINA FRAME | 053-055



LED
LOGS | 057



SECKET
GRAFIT | 059



SECKET
GRAFIT | 061



LED
QUADRULO | 063



SECKET
RUSTY® SLOT | 064-065



LED
SECKET
RUSTY® PATHLIGHT | 066-067

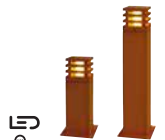

LED
SECKET
RUSTY® | 068-069



SECKET
RUSTY® CONE | 071



SECKET
RUSTY® | 072



SECKET
ARROCK GRANITE | 073



SECKET
ARROCK ARC | 074



LED
ARROCK STONE | 075



SECKET
ARROCK SLOT | 075



LED
L-LINE OUT | 076-077

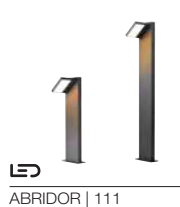



1008477



1008476

GRID SUN FL

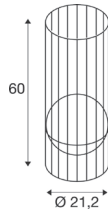

220-240 V ~50/60 Hz | 24 V
Total wattage: 8 W
Material: Steel/Plastic PC

- IP44 24 V plug-in power supply



500lm|2700 K

Options	Prod. no.
● black/opaque	1008476

GRID CUBE FL

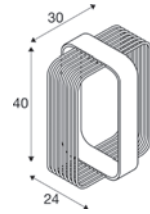

220-240 V ~50/60 Hz | 24 V
Total wattage: 8 W
Material: Steel

- IP44 24 V plug-in power supply



250lm|2700 K

Options	Prod. no.
● black	1008477



1008388

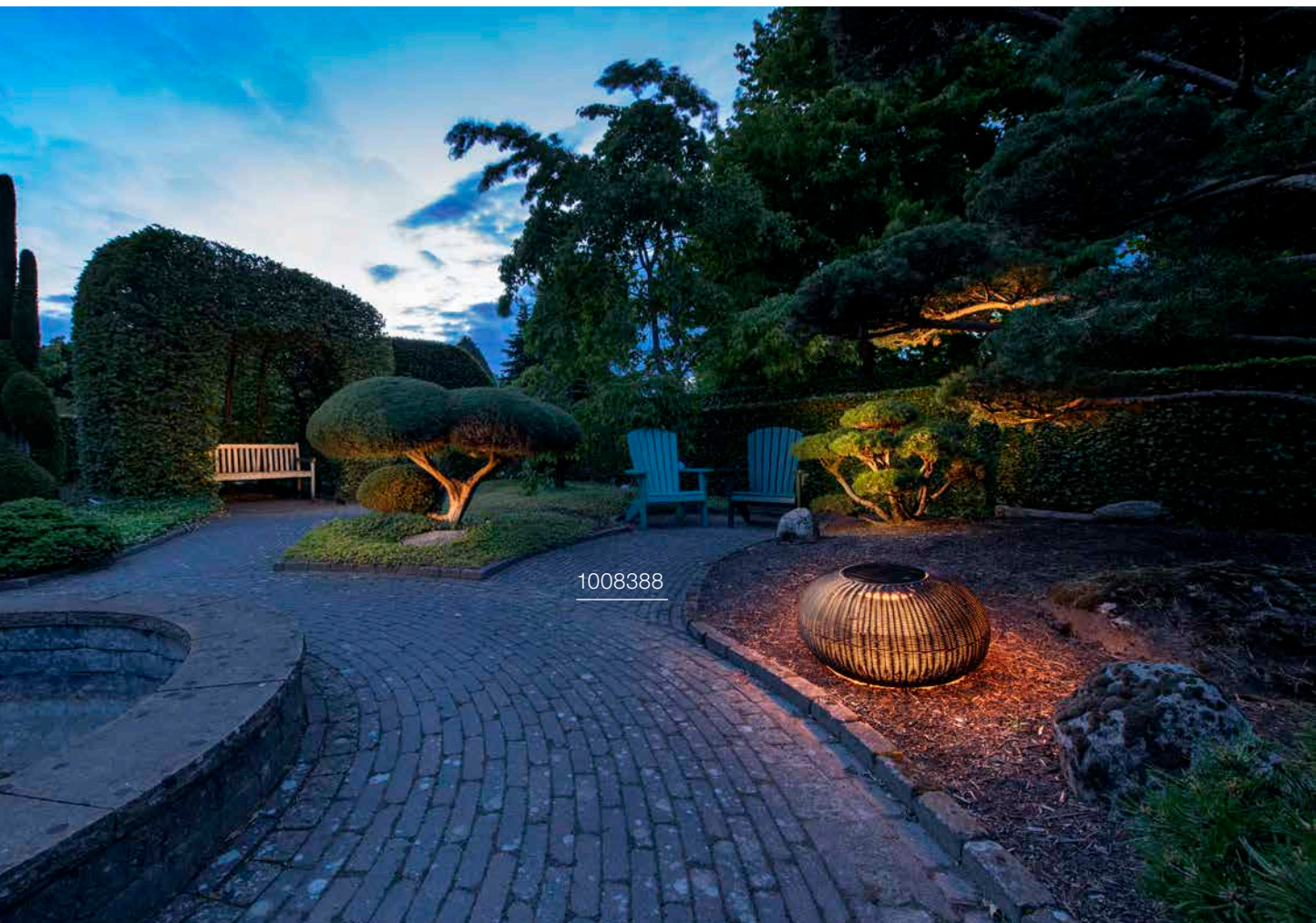

1008388



ADEGAN FL, Flat SOLAR

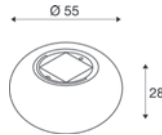

Power consumption: 4.3500
Material: PE/Steel/Plastic PC

- 2.5m USB-C charging cable included
- The light switches off while charging via USB cable
- The light can be dimmed in 3 stages (100/50/25%)



75 lm	2200 K	35 lm	20 lm
85 lm		40 lm	

Options	Prod. no.
● black 75 lm	1008388
●● brown/black 85 lm	1008389

ADEGAN FL, SOLAR

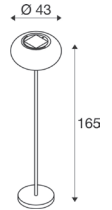

Power consumption: 4.3500
Material: PE/Steel

- 2.5m USB-C charging cable included
- The light switches off while charging via USB cable
- The light can be dimmed in 3 stages (100/50/25%)



85 lm	2200 K	40 lm	20 lm
100 lm		45 lm	

Options	Prod. no.
● black 85 lm	1008386
●● brown/black 100 lm	1008387



1007357



1007360



VINOLINA ONE TL, Battery

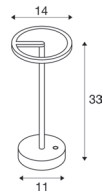

5 V
Total wattage: 2.5 W
Material: Aluminium

- Running time 12h
- Charging time 7h
- charging plate included
- power adapter not included
- USB-A



125lm|2700K

Options	Prod. no.
● black	1007359
○ white	1007357
● rust	1007358

VINOLINA TL, Battery

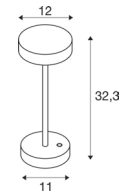

5 V
Total wattage: 2.2 W
Material: Aluminium

- Running time 12h
- Charging time 7h
- charging plate included
- power adapter not included
- USB-A



130lm|2700K | 130lm|3000K

Options	Prod. no.
● black	1007362
○ white	1007360
● rust	1007361

1007695





VINOLINA TWO

TL, Battery, DTW

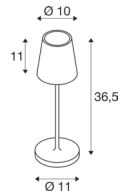

5 V
Total wattage: 2 W
Material: Aluminium/Plastic

- Running time 10h
- Charging time 5h
- Charging station for one light included
- USB-A



140lm|2200K | 170lm|2700K | 190lm|3000K

Options	Prod. no.
● black	1007693
○ white	1007692
● sand	1007697
● rust	1007695
● red	1007694
● sage green	1007696



Product	Prod. no.
Charging base	
● black	1007698

VINOLINA TWO

Charging base



L: 46.2 cm
W: 32.6 cm
H: 5 cm
Material: Plastic

- Charging base for max. 6
- Connection cable available separately

Options	Prod. no.
● black	1007698

VINOLINA TWO

IEC connection cable with safety plug



L: 180 cm

Options	Prod. no.
● black	1008029



1007380



1007380



TAHA

Light set, battery-powered

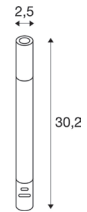

100-240 V ~50/60 Hz | 5 V

Total wattage: 5 W

Material: Aluminium/Plastic

- In addition to the light, the light set includes two different lampshades, an extension tube, USB-C charging cable, ground spike and a loop for hanging temporarily on branches and beams.
- 3 dimming levels
- IP44 plug-in power supply



200lm|2700 K

Options	Prod. no.
● black	1007380

1007651



1007652





S-TUBE 32

Pole, GU10

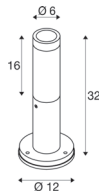

220-240 V ~50/60 Hz
Material: Aluminium

- open cable end
- streamlined design



Base: 1xGU10 max. Ø: 5.1 cm | L: 5.5 cm

Options	Prod. no.
● black	1007651



GU10 | 2 W | 36°
230 lm | 2700 K | EEC = E
3 kW/1000h

Prod. no.: 1007230

S-TUBE 75

Pole, GU10

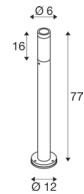

220-240 V ~50/60 Hz
Material: Aluminium

- open cable end
- streamlined design



Base: 1xGU10 max. Ø: 5.1 cm | L: 5.5 cm

Options	Prod. no.
● black	1007652



GU10 | 2 W | 36°
230 lm | 2700 K | EEC = E
3 kW/1000h

Prod. no.: 1007230



Product	Prod. no.
Connection box IP68, 3-pole	
● black	228730



Product	Prod. no.
Connection box IP68, 3-pole	
● black	228730

T-TUBE 70
Pole, GU10, single, Sensor

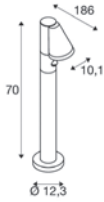

220-240 V ~50/60 Hz
Material: Aluminium

- Primary and replica functionality possible with accessories
- PIR sensor, adjustable range 10-2000lx and 5s-10min. Detection range up to 8 m depending on the mounting height of the light
- IP connection box



Base: 1xGU10 max. Ø: 5.1 cm | L: 5.5 cm

Options	Prod. no.
● black	1008014



GU10 | 6 W | 38°
450 lm | 2700 K | EEC = F
6 kW/1000h



Prod. no.: 1005077

T-TUBE 70
Pole, GU10, double, Sensor

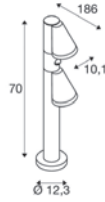

220-240 V ~50/60 Hz
Material: Aluminium

- Primary and replica functionality possible with accessories
- PIR sensor, adjustable range 10-2000lx and 5s-10min. Detection range up to 8 m depending on the mounting height of the light
- IP connection box



Base: 1xGU10 max. Ø: 5.1 cm | L: 5.5 cm

Options	Prod. no.
● black	1008015



GU10 | 6 W | 38°
450 lm | 2700 K | EEC = F
6 kW/1000h



Prod. no.: 1005077

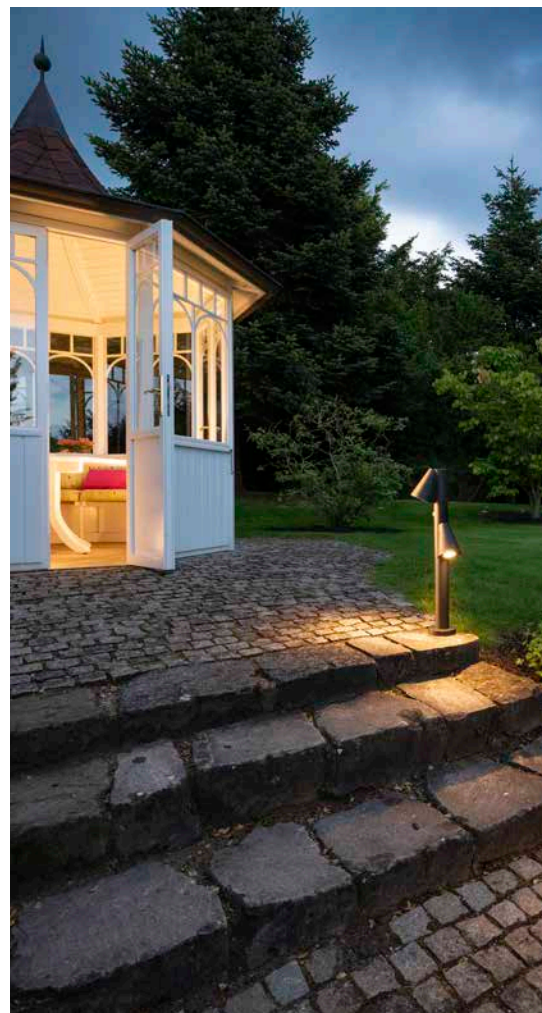



T-TUBE 70

Pole, GU10, single

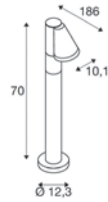

220-240 V ~50/60 Hz
Material: Aluminium

- IP connection box

T-TUBE 70

Pole, GU10, double

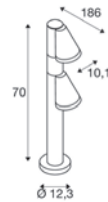

220-240 V ~50/60 Hz
Material: Aluminium

- IP connection box

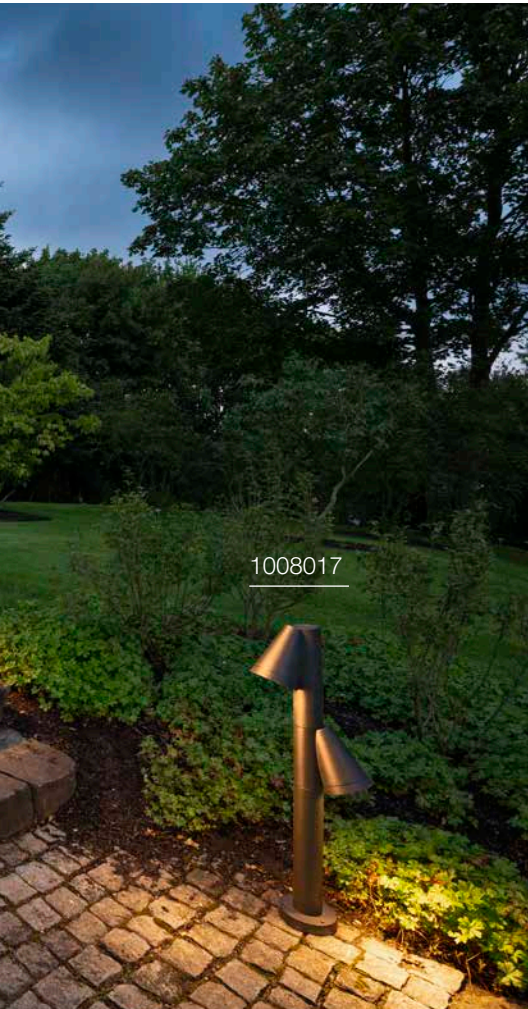

1008017



Base: 1xGU10 max. Ø: 5.1 cm | L: 5.5 cm

Options	Prod. no.
● black	1008016



GU10 | 6W | 38°
450 lm | 2700K | EEC = F
6 kW/1000h



Prod. no.: 1005077



Base: 1xGU10 max. Ø: 5.1 cm | L: 5.5 cm

Options	Prod. no.
● black	1008017



GU10 | 6W | 38°
450 lm | 2700K | EEC = F
6 kW/1000h



Prod. no.: 1005077



1008194

PHOTONI CYL 45

Pole, E27

PHOTONI CYL 75

Pole, E27

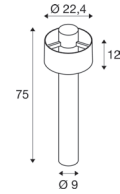
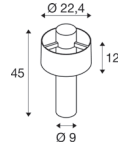

220-240 V ~50/60 Hz
Material: Aluminium

220-240 V ~50/60 Hz
Material: Aluminium

- IP connection box

- IP connection box



Base: 1xE27 max. Ø: 6cm | L: 11.6cm

Base: 1xE27 max. Ø: 6cm | L: 11.6cm

Options	Prod. no.
● black	1008195
● rust	1008196

Options	Prod. no.
● black	1008193
● rust	1008194



E27 | 8 W | 180°
720 lm | 2700 K | EEC = F
8 kW/1000h



E27 | 8 W | 180°
720 lm | 2700 K | EEC = F
8 kW/1000h

Prod. no.: **1005305**

Prod. no.: **1005305**



1007587

1007584

PHOTONI 45

Pole, E27

PHOTONI 75

Pole, E27

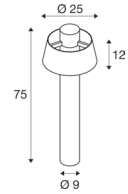
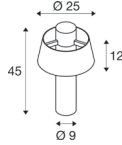

220-240 V ~50/60 Hz
Material: Aluminium

220-240 V ~50/60 Hz
Material: Aluminium

- Sea-air resistant
- IP connection box

- Sea-air resistant
- IP connection box



Base: 1xE27 max. Ø: 6 cm L: 11.6 cm

Base: 1xE27 max. Ø: 6 cm L: 11.6 cm

Options	Prod. no.
● black	1007587
● rust	1007583

Options	Prod. no.
● black	1007584
● rust	1007580



E27 | 8 W | 180°
720lm | 2700 K | EEC = F
8 kW/1000h



E27 | 8 W | 180°
720lm | 2700 K | EEC = F
8 kW/1000h

Prod. no.: **1005305**

Prod. no.: **1005305**



S-CUBE Pole, PHASE

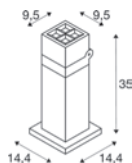

220-240 V ~50/60 Hz | 350 mA
Total wattage: 15 W
Material: Aluminium

- The light colour must be set prior to installation
- open cable end



1000 lm | 2700 K | 1200 lm | 3000 K

Options	Prod. no.
● anthracite	1007460



Product	Prod. no.
Connection box IP68, 3-pole	
● black	228730

S-CUBE 75 Pole, PHASE

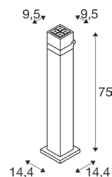

220-240 V ~50/60 Hz | 350 mA
Total wattage: 15 W
Material: Aluminium

- The light colour must be set prior to installation
- open cable end



1000 lm | 2700 K | 1200 lm | 3000 K

Options	Prod. no.
● anthracite	1007459



Product	Prod. no.
Connection box IP68, 3-pole	
● black	228730

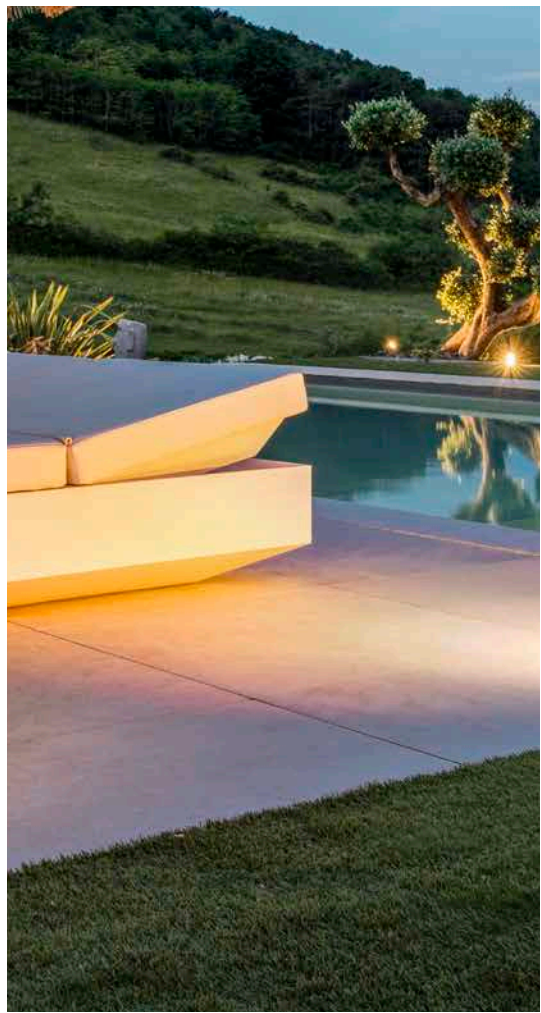
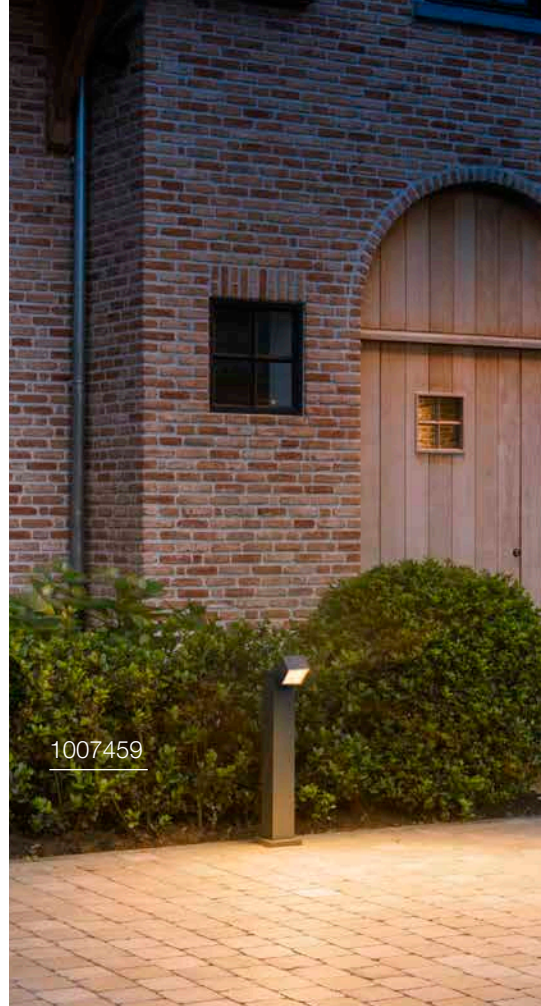



R-CUBE 35

Pole, PHASE

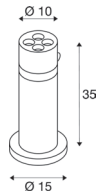

220-240 V ~50/60 Hz | 350 mA
Total wattage: 15 W
Material: Aluminium

- The light colour must be set prior to installation
- open cable end

R-CUBE 75

Pole, PHASE

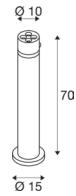

220-240 V ~50/60 Hz | 350 mA
Total wattage: 15 W
Material: Aluminium

- The light colour must be set prior to installation
- open cable end



800 lm | 2700 K | 800 lm | 3000 K

Options	Prod. no.
● anthracite	1007513



Product	Prod. no.
Connection box IP68, 3-pole	
● black	228730



800 lm | 2700 K | 800 lm | 3000 K

Options	Prod. no.
● anthracite	1007512



Product	Prod. no.
Connection box IP68, 3-pole	
● black	228730



1007513

I-RING 65

Pole

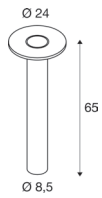

100-240 V ~50/60 Hz | 350 mA
 Total wattage: 9.2 W
 Material: Aluminium

- IP68 connection box



670lm|3000K

Options	Prod. no.
● anthracite	1007237



Product	Prod. no.
Screw set	
● Stainless steel	228753

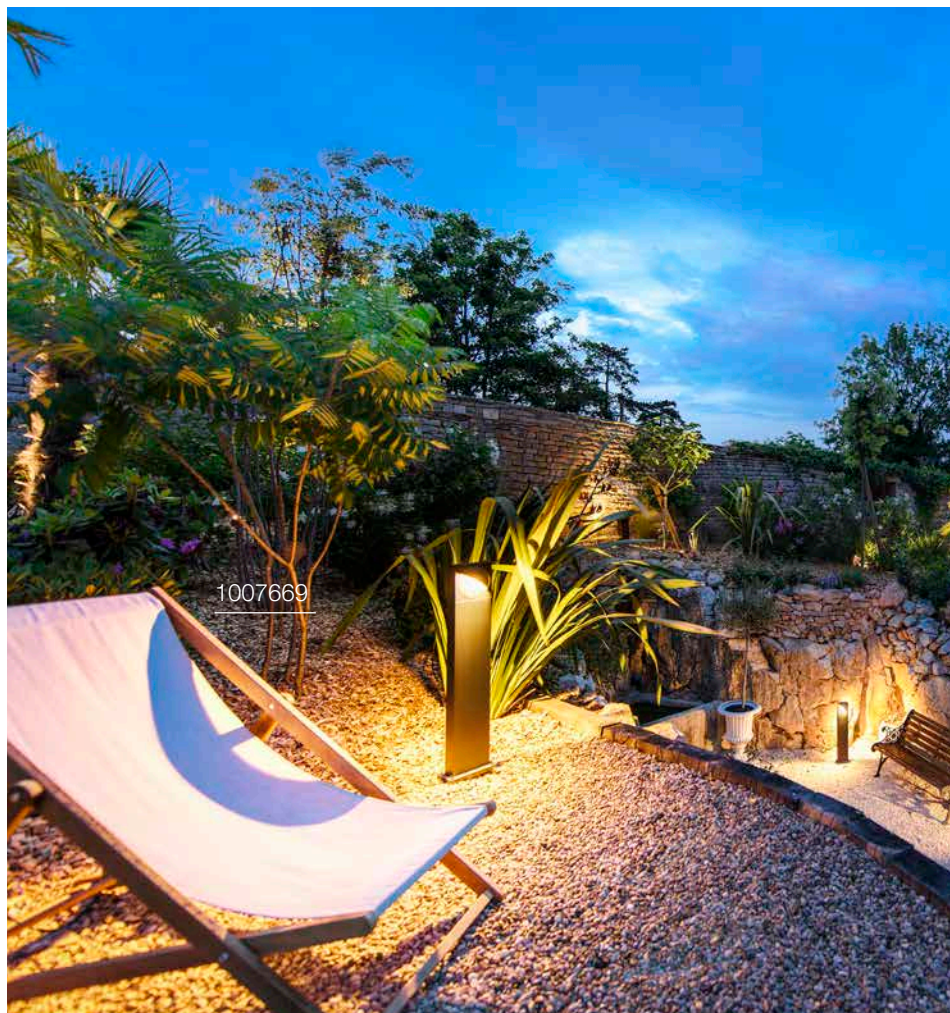



LID I 45

Pole, single, PHASE

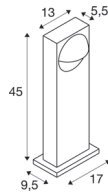

220-240 V ~50/60 Hz | 350 mA
Total wattage: 15 W
Material: Aluminium

- open cable end
- The light colour must be set prior to installation

LID I 75

Pole, double, PHASE

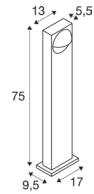

220-240 V ~50/60 Hz | 700 mA
Total wattage: 29 W
Material: Aluminium

- open cable end
- The light colour must be set prior to installation



900 lm | 2700 K | 1050 lm | 3000 K

Options	Prod. no.
● anthracite	1007670



Product	Prod. no.
Connection box IP68, 3-pole	
● black	228730



Direct 850 lm | 2700 K | 1000 lm | 3000 K

Options	Prod. no.
● anthracite	1007669



Product	Prod. no.
Connection box IP68, 3-pole	
● black	228730



QUAD PRO 60

Pole, DALI

QUAD PRO 90

Pole, DALI

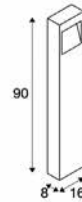
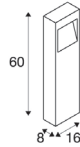

100-240 V ~50/60 Hz | 500 mA
Total wattage: 14 W
Material: Aluminium

100-240 V ~50/60 Hz | 500 mA
Total wattage: 14 W
Material: Aluminium

- asym. Light distribution for optimum illumination of paths
- ULOR <2% to avoid light pollution
- IP connection box

- asym. Light distribution for optimum illumination of paths
- ULOR <2% to avoid light pollution
- IP connection box



Asymetrical 450 lm | 2200 K
Asymetrical 500 lm | 2700 K

Asymetrical 450 lm | 2200 K
Asymetrical 500 lm | 2700 K

Options	Prod. no.
● anthracite 450 lm 2200 K	1010204
● anthracite 500 lm 2700 K	1010205

Options	Prod. no.
● anthracite 450 lm 2200 K	1010202
● anthracite 500 lm 2700 K	1010203

M-POL S
Polehead 360°, glare reduction

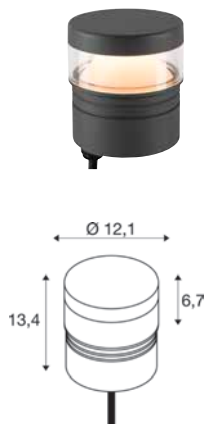

220-240 V ~50/60 Hz | 500 mA
Total wattage: 10 W
Material: Aluminium

- The light colour must be set prior to installation
- Sea-air resistant
- open cable end
- Matching accessories can be found on page 722-723



750lm|2700 K

Options	Prod. no.
● anthracite	1007232



Product	Prod. no.
T-connector box	
● black	228726
Connection box IP68, 3-pole	
● black	228730

M-POL S
Polehead 360°, glare reduction, DALI

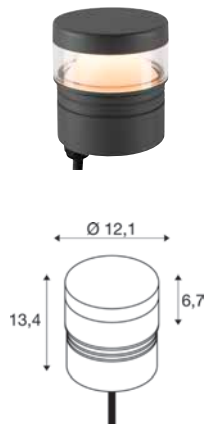

220-240 V ~50/60 Hz | 500 mA
Total wattage: 10 W
Material: Aluminium

- The light colour must be set prior to installation
- Sea-air resistant
- open cable end
- Matching accessories can be found on page 722-723



750lm|2700 K

Options	Prod. no.
● anthracite	1007233



Product	Prod. no.
Connection box	
● black	228725
IP68 connection box, 5-pin	
● black	1006453

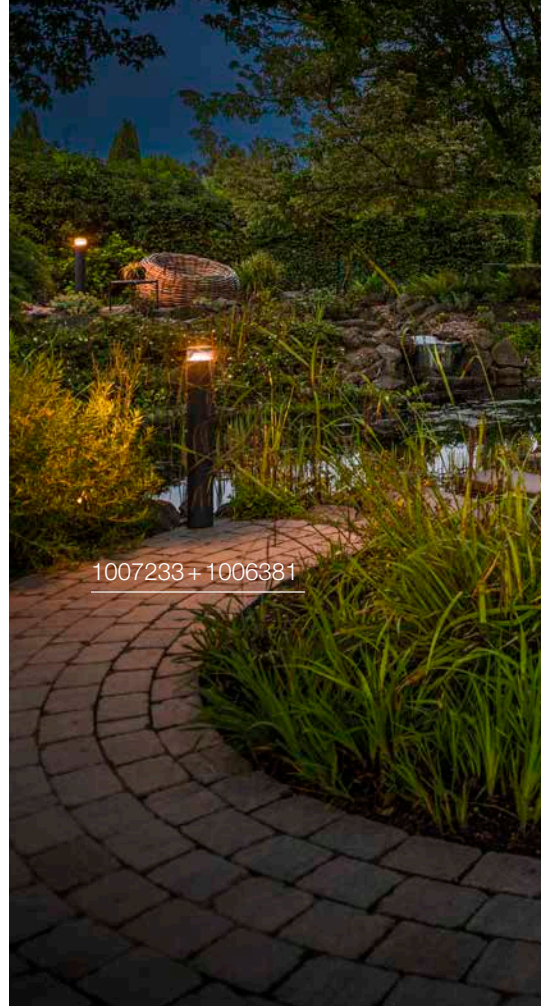

1007233 + 1006381

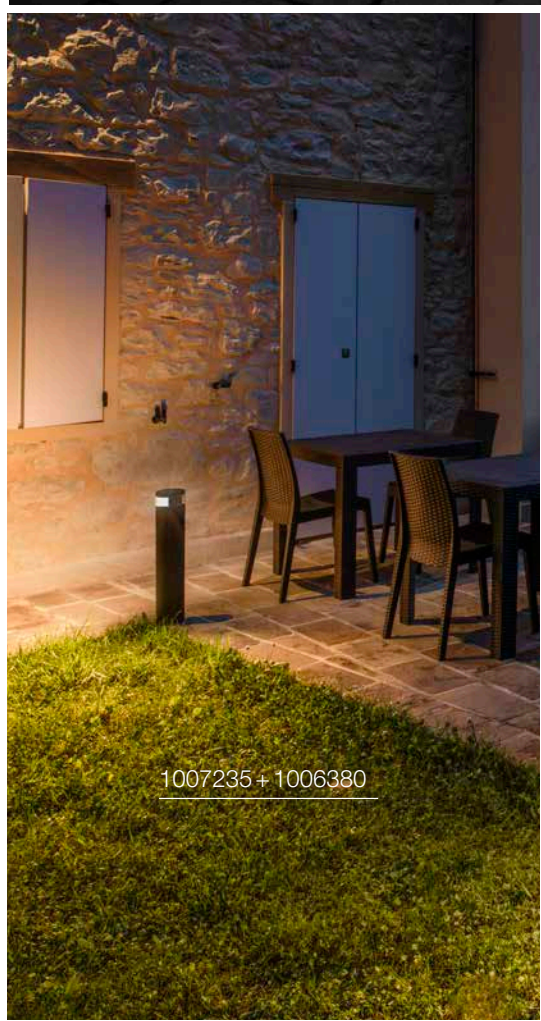

1007235 + 1006380



M-POL S

Polehead 180°, glare reduction

M-POL S

Polehead 180°, glare reduction, DALI

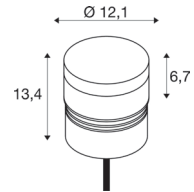
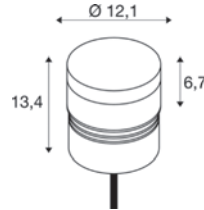

220-240 V ~50/60 Hz | 500 mA
Total wattage: 10 W
Material: Aluminium

220-240 V ~50/60 Hz | 500 mA
Total wattage: 10 W
Material: Aluminium

- The light colour must be set prior to installation
- Sea-air resistant
- open cable end
- Matching accessories can be found on page 722-723

- The light colour must be set prior to installation
- Sea-air resistant
- open cable end
- Matching accessories can be found on page 722-723



700lm|2700 K

700lm|2700 K

Options	Prod. no.
● anthracite	1007234

Options	Prod. no.
● anthracite	1007235



Product	Prod. no.
T-connector box	
● black	228726
Connection box IP68, 3-pole	
● black	228730

Product	Prod. no.
Connection box	
● black	228725
IP68 connection box, 5-pin	
● black	1006453



1006389 + 1006381

M-POL S Polehead

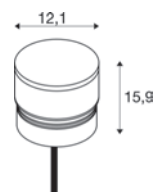

220-240 V ~50/60 Hz | 500 mA
Total wattage: 11 W
Material: Aluminium

- The light colour must be set prior to installation
- Sea-air resistant
- open cable end
- Matching accessories can be found on page 722-723



1006389 + 1006379



Indirect 470lm|2700 K | 510lm|3000 K

Options	Prod. no.
● anthracite	1006383



Product	Prod. no.
T-connector box	
● black	228726
Connection box IP68, 3-pole	
● black	228730

M-POL S Polehead, DALI

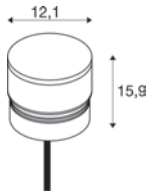

220-240 V ~50/60 Hz | 500 mA
Total wattage: 19 W
Material: Aluminium

- The light colour must be set prior to installation
- Sea-air resistant
- open cable end
- Matching accessories can be found on page 722-723



Indirect 890 lm | 2700 K | 950 lm | 3000 K

Options	Prod. no.
● anthracite	1006389



Product	Prod. no.
Connection box	
● black	228725
IP68 connection box, 5-pin	
● black	1006453

M-POL S Polehead, Shader

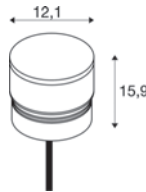

220-240 V ~50/60 Hz | 500 mA
Total wattage: 11 W
Material: Aluminium

- The light colour must be set prior to installation
- Sea-air resistant
- open cable end
- Matching accessories can be found on page 722-723



Indirect 285 lm | 2700 K | 310 lm | 3000 K

Options	Prod. no.
● anthracite	1006387



Product	Prod. no.
T-connector box	
● black	228726
Connection box IP68, 3-pole	
● black	228730

M-POL S Polehead, Shader, DALI

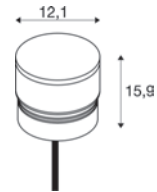

220-240 V ~50/60 Hz | 500 mA
Total wattage: 19 W
Material: Aluminium

- The light colour must be set prior to installation
- Sea-air resistant
- open cable end
- Matching accessories can be found on page 722-723



Indirect 520 lm | 2700 K | 550 lm | 3000 K

Options	Prod. no.
● anthracite	1006393



Product	Prod. no.
Connection box	
● black	228725
IP68 connection box, 5-pin	
● black	1006453

M-POL S

Polehead, Louver

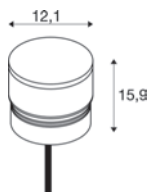

220-240 V ~50/60 Hz | 500 mA
 Total wattage: 11 W
 Material: Aluminium

- The light colour must be set prior to installation
- Sea-air resistant
- open cable end
- Matching accessories can be found on page 722-723



Indirect 145 lm | 2700 K | 155 lm | 3000 K

Options

Prod. no.

- anthracite 1006385



Product

Prod. no.

- T-connector box
- black 228726
- Connection box IP68, 3-pole
- black 228730

M-POL S

Polehead, Louver, DALI

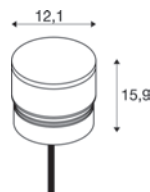

220-240 V ~50/60 Hz | 500 mA
 Total wattage: 19 W
 Material: Aluminium

- The light colour must be set prior to installation
- Sea-air resistant
- open cable end
- Matching accessories can be found on page 722-723



Indirect 260 lm | 2700 K | 270 lm | 3000 K

Options

Prod. no.

- anthracite 1006391



Product

Prod. no.

- Connection box
- black 228725
- IP68 connection box, 5-pin
- black 1006453

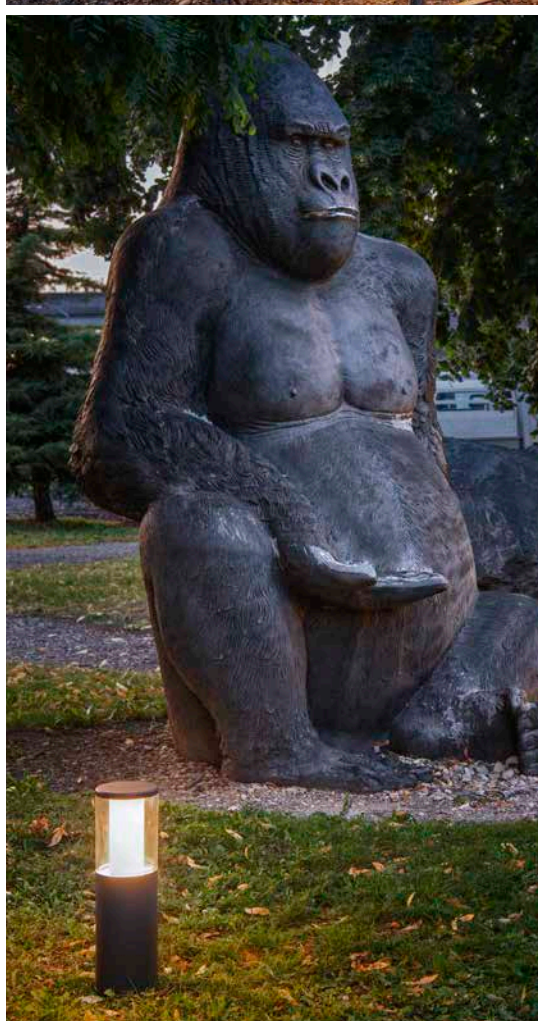



1006391 + 1006381



1006384 + 1006379

M-POL M Polehead

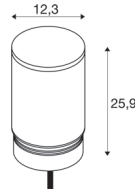

220-240 V ~50/60 Hz | 500 mA
Total wattage: 11 W
Material: Aluminium

- The light colour must be set prior to installation
- Sea-air resistant
- open cable end
- Matching accessories can be found on page 722-723



Indirect 590 lm | 2700 K | 660 lm | 3000 K

Options	Prod. no.
● anthracite	1006384



Product	Prod. no.
T-connector box	
● black	228726
Connection box IP68, 3-pole	
● black	228730

M-POL M Polehead, DALI

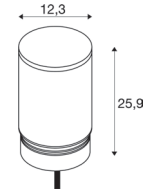

220-240 V ~50/60 Hz | 500 mA
Total wattage: 19 W
Material: Aluminium

- The light colour must be set prior to installation
- Sea-air resistant
- open cable end
- Matching accessories can be found on page 722-723



Indirect 1150 lm | 2700 K | 1230 lm | 3000 K

Options	Prod. no.
● anthracite	1006390



Product	Prod. no.
Connection box	
● black	228725
IP68 connection box, 5-pin	
● black	1006453



1006388 + 1006381

M-POL M Polehead, Shader

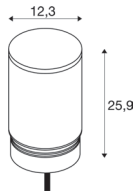

220-240 V ~50/60 Hz | 500 mA
Total wattage: 11 W
Material: Aluminium

- The light colour must be set prior to installation
- Sea-air resistant
- open cable end
- Matching accessories can be found on page 722-723



Indirect 420 lm | 2700 K | 460 lm | 3000 K

Options	Prod. no.
● anthracite	1006388



Product	Prod. no.
T-connector box	
● black	228726
Connection box IP68, 3-pole	
● black	228730

M-POL M Polehead, Shader, DALI

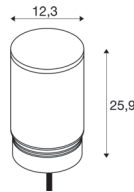

220-240 V ~50/60 Hz | 500 mA
Total wattage: 19 W
Material: Aluminium

- The light colour must be set prior to installation
- Sea-air resistant
- open cable end
- Matching accessories can be found on page 722-723



Indirect 820 lm | 2700 K | 870 lm | 3000 K

Options	Prod. no.
● anthracite	1006394



Product	Prod. no.
Connection box	
● black	228725
IP68 connection box, 5-pin	
● black	1006453

M-POL M Polehead, Louver

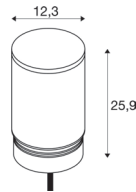

220-240 V ~50/60 Hz | 500 mA
Total wattage: 11 W
Material: Aluminium

- The light colour must be set prior to installation
- Sea-air resistant
- open cable end
- Matching accessories can be found on page 722-723



Indirect 190 lm | 2700 K | 210 lm | 3000 K

Options	Prod. no.
● anthracite	1006386



Product	Prod. no.
T-connector box	
● black	228726
Connection box IP68, 3-pole	
● black	228730

M-POL M Polehead, Louver, DALI

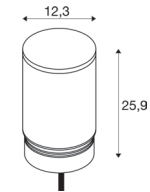

220-240 V ~50/60 Hz | 500 mA
Total wattage: 19 W
Material: Aluminium

- The light colour must be set prior to installation
- Sea-air resistant
- open cable end
- Matching accessories can be found on page 722-723



Indirect 350 lm | 2700 K | 370 lm | 3000 K

Options	Prod. no.
● anthracite	1006392



Product	Prod. no.
Connection box	
● black	228725
IP68 connection box, 5-pin	
● black	1006453

1006392 + 1006381





1008474

M-POL Cover

Ø: 12,4



Ø: 12 cm
H: 2.2 cm
Material: Aluminium

M-POL Pole 60, Socket

Ø: 12,4



53,4



Ø: 12.4 cm
H: 53,4 cm
Material: Aluminium

Options	Prod. no.
● anthracite	1008475

Options	Prod. no.
● anthracite	1008474



Product	Prod. no.
T-connector box	
● black	228726
Connection box IP68, 3-pole	
● black	228730
Ground anchor set	
● Stainless steel	1006382
Connection box, 5 poles, IP68	
● black	1006453
Cover	
● anthracite	1008475



M-POL 30 Pole



Ø: 12.4 cm
H: 23.4 cm
Material: Aluminium

- Sea-air resistant

Options	Prod. no.
● anthracite	1006379



Product	Prod. no.
Ground anchor set	
● Stainless steel	1006382

M-POL 60 Pole

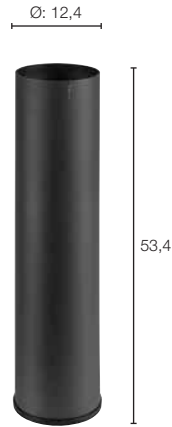

Ø: 12.4 cm
H: 53.4 cm
Material: Aluminium

- Sea-air resistant

Options	Prod. no.
● anthracite	1006380



Product	Prod. no.
Ground anchor set	
● Stainless steel	1006382

M-POL 90 Pole

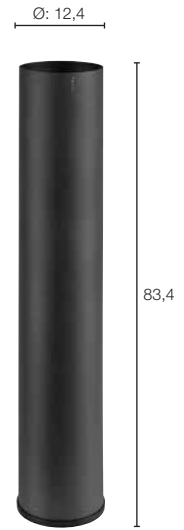

Ø: 12.4 cm
H: 83.4 cm
Material: Aluminium

- Sea-air resistant

Options	Prod. no.
● anthracite	1006381



Product	Prod. no.
Ground anchor set	
● Stainless steel	1006382

DESIGN YOUR M-POL SYSTEM

The right bollard lights in a few steps – made possible with the M-POL system. It combines three sizes and eight lamp heads with five light properties and two colour temperatures. Whether in high or flat form, with shaders for less light on one side, homogeneous and diffuse radiance or glare-free thanks to integrated louvres. Whether 2700 or 3000 Kelvin, controllable as an On/Off version or DALI. Configure your chosen M-POL bollard lights and showcase every outdoor ambience in its best light.

CHOOSE YOUR PREFERRED ...

- 1 bollard (30, 60, 90)
- 2 Lamp head (On/Off, DALI)
- 3 Lamp head size (high, flat)
- 4 Light property (Clear, Shader, Louver)
- 5 Colour temperature (2700 K, 3000 K)



DONE!

LAMP HEADS

M-POL S

Ø: 12,3 cm, H: 15,9 cm

M-POL M

Ø: 12,3 cm, H: 25,9 cm

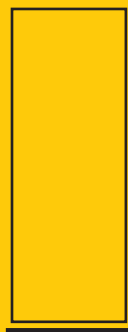
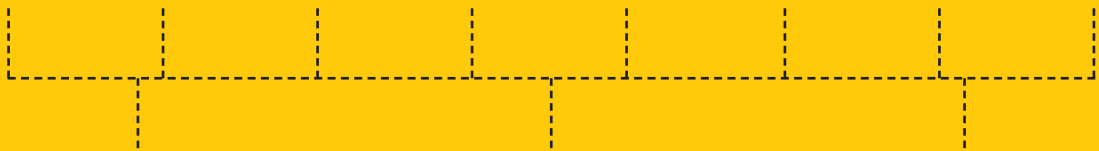
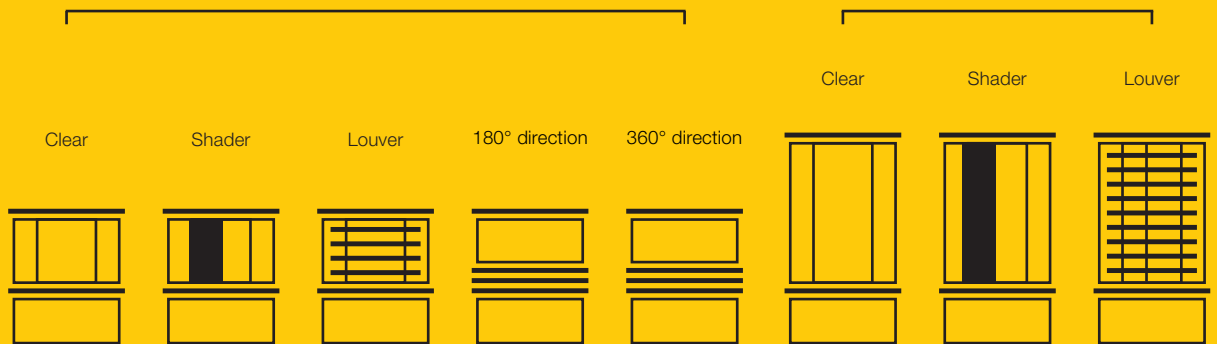

M-POL 30

Ø: 12,4 cm, H: 23,4 cm



M-POL 60

Ø: 12,4 cm, H: 53,4 cm



M-POL 90

Ø: 12,4 cm, H: 83,4 cm

BOLLARD

CONCRETE 35

Pole, PHASE

NEW

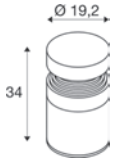

220-240 V ~50/60 Hz | 350 mA
 Total wattage: 15 W
 Material: concrete

- Bayonet lock enables easy assembly
- IP connection box



1008839



Down 600lm|2700 K

Options	Prod. no.
● grey	1008838 ●





CONCRETE 55 Pole, PHASE

NEW

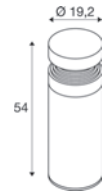

220-240 V ~50/60 Hz | 350 mA

Total wattage: 15 W

Material: concrete

- Bayonet lock enables easy assembly
- IP connection box

1008838



Down

600lm|2700K

Options

Prod. no.

● grey

1008839 ●

1008838



1006408



CONCRETO FL, round, QPAR 51

CONCRETO FL, square, QPAR51

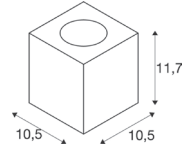
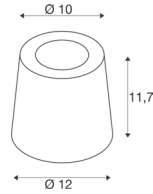

220-240 V ~50/60 Hz
Material: Concrete/Aluminium

220-240 V ~50/60 Hz
Material: Concrete/Aluminium

- IP44 safety plug

- IP44 safety plug



Base: 1xGU10 max. Ø: 5.1 cm | L: 6 cm

Base: 1xGU10 max. Ø: 5.1 cm | L: 6 cm

Options	Prod. no.
● grey/black	1006408

Options	Prod. no.
● grey/black	1006409



GU10 | 2W | 36°
230lm | 2700K | EEC = E
3kW/1000h

Prod. no.: 1007230



GU10 | 2W | 36°
230lm | 2700K | EEC = E
3kW/1000h

Prod. no.: 1007230



1008385



RASTERLYS 70

Pole, PHASE

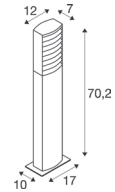

220-240 V ~0/50/60 Hz | 700 mA
Total wattage: 27 W
Material: Aluminium

- The light colour must be set prior to installation
- Suitable for DC operation
- open cable end



2x350 lm | 2700 K | 2x375 lm | 3000 K

Options	Prod. no.
● anthracite	1008385



Product	Prod. no.
T-connector box	
● black	228726
Connection box IP68, 3-pole	
● black	228730



FLATT II 36

Pole, PHASE

FLATT II 62

Pole, PHASE

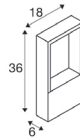

220-240 V ~50/60 Hz | 240 mA
Total wattage: 10 W
Material: Aluminium

220-240 V ~50/60 Hz | 240 mA
Total wattage: 10 W
Material: Aluminium

- open cable end

- open cable end



650lm|2700 K

650lm|2700 K

Options	Prod. no.
● black	1010104 ●
●● anthracite/brown	1010103 ●

Options	Prod. no.
● black	1010106 ●
●● anthracite/brown	1010105 ●



Product	Prod. no.
T-connector box	
● black	228726
Connection box IP68, 3-pole	
● black	228730

Product	Prod. no.
T-connector box	
● black	228726
Connection box IP68, 3-pole	
● black	228730



1002957

FLATT 65 Pole

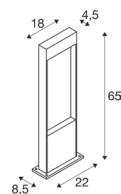

100-240 V ~50/60 Hz | 350 mA

Total wattage: 10 W

Material: Aluminium

- The light colour must be set prior to installation
- open cable end



400 lm | 3000 K | 4000 K

Options	Prod. no.
● anthracite	1002956
● brown/anthracite	1002957



Product	Prod. no.
Connection box IP68, 3-pole	
● black	228730



FLATT 100 Pole

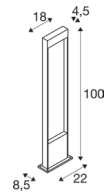

100-240 V ~50/60 Hz | 350 mA
Total wattage: 10 W
Material: Aluminium

- The light colour must be set prior to installation
- open cable end



400 lm | 3000 K | 4000 K

Options	Prod. no.
● anthracite	1002958
● brown/anthracite	1002959



Product	Prod. no.
Connection box IP68, 3-pole	
● black	228730

1002958

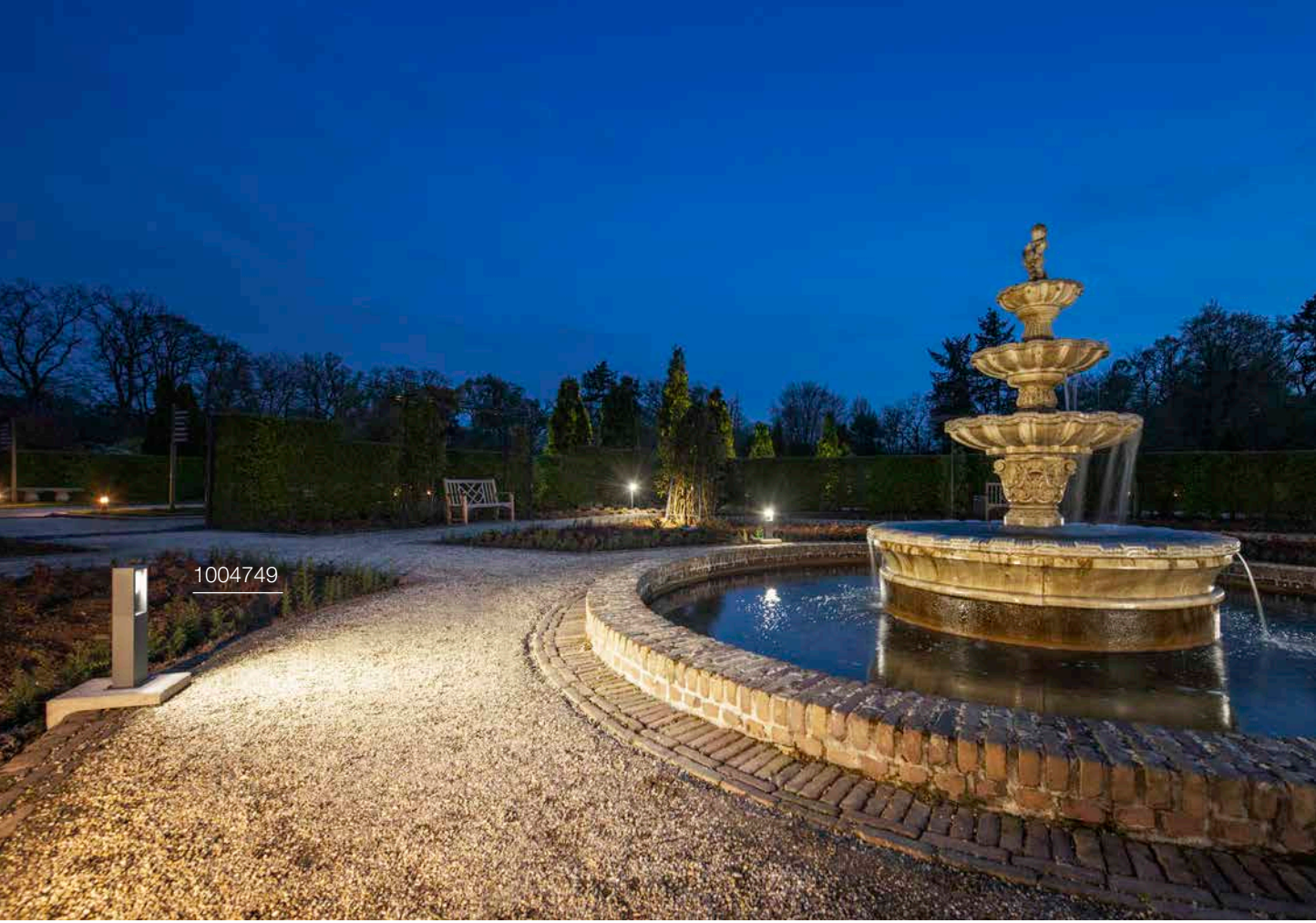

ESKINA FRAME 45

Pole, single

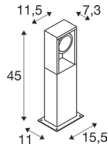

220-240 V ~50/60 Hz | 350 mA
Total wattage: 15 W
Material: Aluminium

- The light colour must be set prior to installation
- open cable end



Spot 1100 lm | 3000 K | 1200 lm | 4000 K

Options	Prod. no.
● anthracite	1004749



Product	Prod. no.
Connection box IP68, 3-pole	
● black	228730

ESKINA FRAME 78

Pole, single

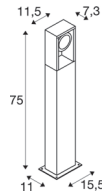

220-240 V ~50/60 Hz | 350 mA
Total wattage: 15 W
Material: Aluminium

- The light colour must be set prior to installation
- open cable end



Spot 1100 lm | 3000 K | 1200 lm | 4000 K

Options	Prod. no.
● anthracite	1004750



Product	Prod. no.
Connection box IP68, 3-pole	
● black	228730

ESKINA FRAME 78

Pole, double

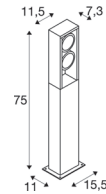

220-240 V ~50/60 Hz | 700 mA
Total wattage: 27 W
Material: Aluminium

- The light colour must be set prior to installation
- open cable end



Spot 1 1100 lm | 3000 K | 1200 lm | 4000 K

Options	Prod. no.
● anthracite	1004751



Product	Prod. no.
Connection box IP68, 3-pole	
● black	228730



1005439



ESKINA FRAME 125

Pole, double

ESKINA FRAME 175

Pole, double

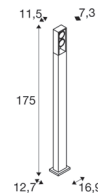
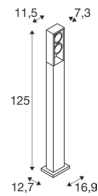

220-240 V ~50/60 Hz | 700 mA
Total wattage: 27 W
Material: Aluminium

220-240 V ~50/60 Hz | 700 mA
Total wattage: 27 W
Material: Aluminium

- The light colour must be set prior to installation
- open cable end

- The light colour must be set prior to installation
- open cable end



Spot 1+2 1100 lm|3000 K 1200 lm|4000 K

Spot 1 1100 lm|3000 K 1200 lm|4000 K

Options	Prod. no.
● anthracite	1005439

Options	Prod. no.
● anthracite	1005440



Product	Prod. no.
Connection box IP68, 3-pole	
● black	228730

Product	Prod. no.
Connection box IP68, 3-pole	
● black	228730





232115

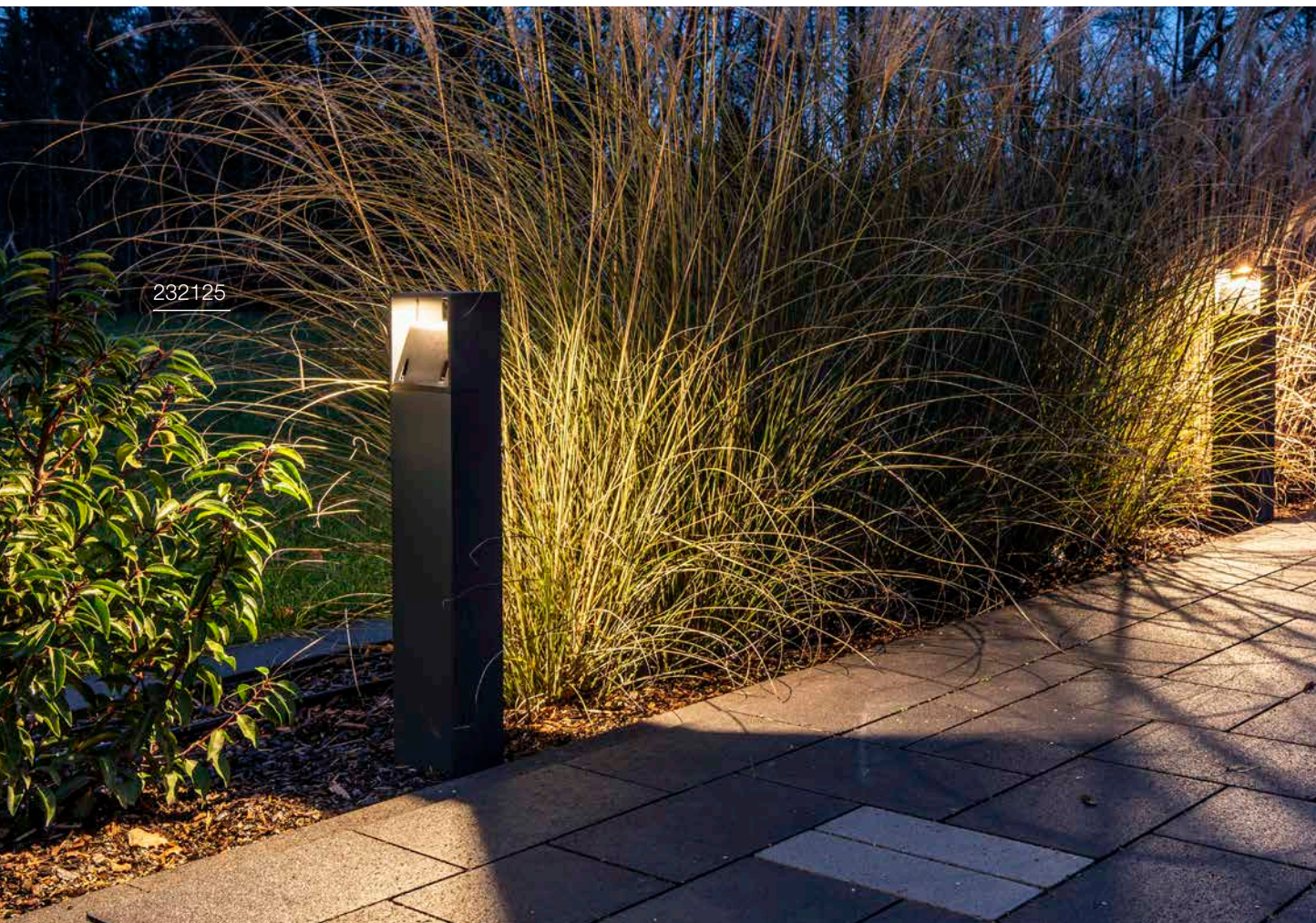

232125

LOGS 40 Pole

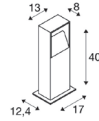

220-240 V ~50/60 Hz | 500 mA
Total wattage: 9.5 W
Material: Aluminium

- open cable end



570lm|3000 K

Options	Prod. no.
● anthracite	232115



Product	Prod. no.
Connection box IP68, 3-pole	
● black	228730
Screw set	
● Stainless steel	228754
Ground spike	
● grey	231230
Concrete anchor	
● grey	232119

LOGS 70 Pole

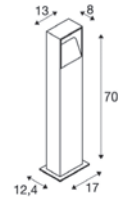

220-240 V ~50/60 Hz | 500 mA
Total wattage: 9.5 W
Material: Aluminium

- open cable end



570lm|3000 K

Options	Prod. no.
● anthracite	232125



Product	Prod. no.
Connection box IP68, 3-pole	
● black	228730
Screw set	
● Stainless steel	228754
Ground spike	
● grey	231230
Concrete anchor	
● grey	232119

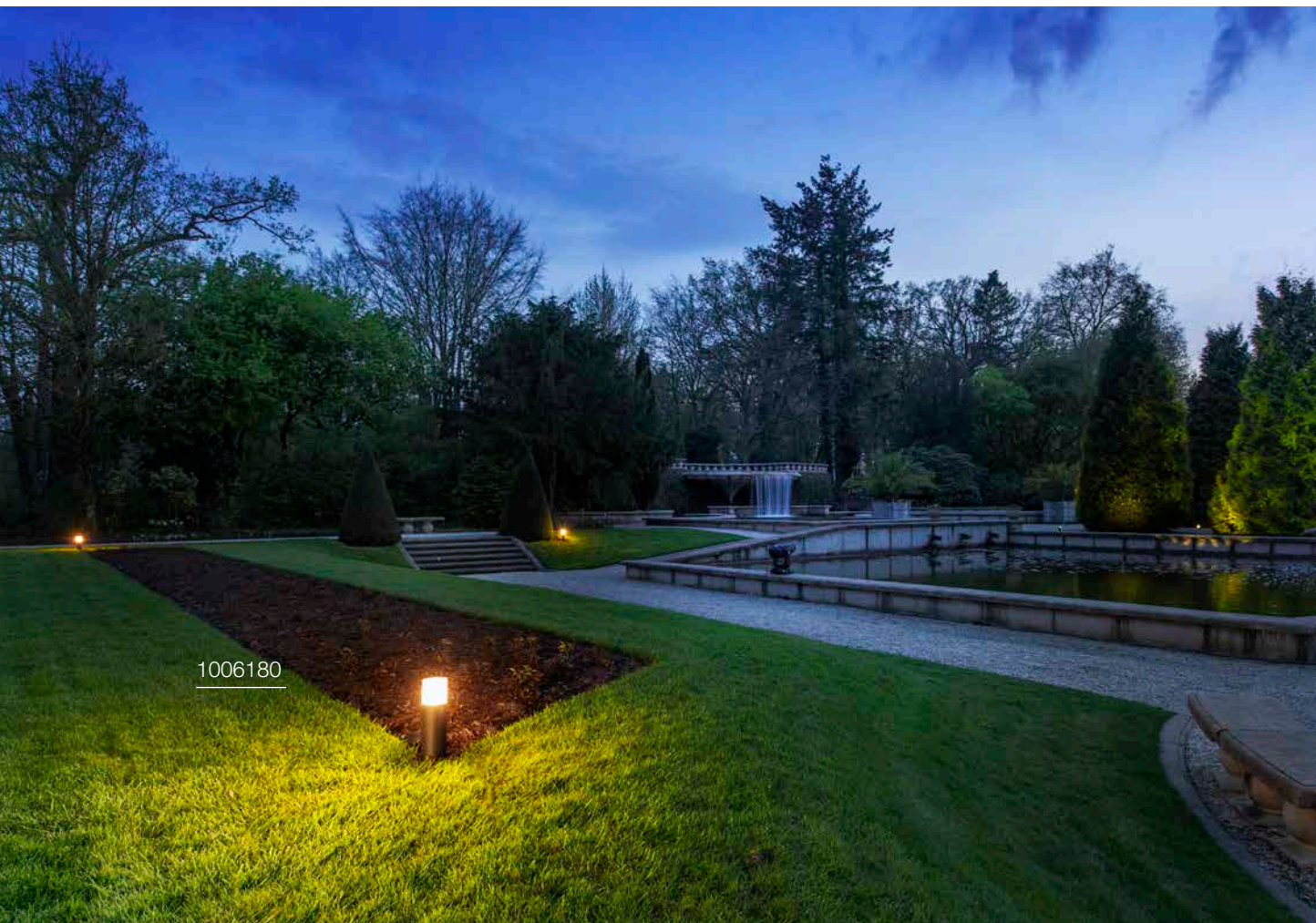

GRAFIT 30

Pole, round, E27

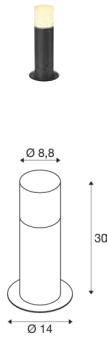

220-240 V ~50/60 Hz
Material: Aluminium/Acrylic

- open cable end



Base: 1xE27 max. Ø: 6 cm | L: 11.5 cm

Options	Prod. no.
● anthracite	1006180



E27 | 8 W | 320°
800 lm | 2700 K | EEC = F
8 kW/1000h



Prod. no.: 1005303



Product	Prod. no.
Connection box IP68, 3-pole	
● black	228730

GRAFIT 60

Pole, round, E27



220-240 V ~50/60 Hz
Material: Aluminium/Acrylic

- open cable end



Base: 1xE27 max. Ø: 6 cm | L: 11.5 cm

Options	Prod. no.
● anthracite	1006181



E27 | 8 W | 320°
800 lm | 2700 K | EEC = F
8 kW/1000h



Prod. no.: 1005303



Product	Prod. no.
Connection box IP68, 3-pole	
● black	228730

GRAFIT 90

Pole, round, E27



220-240 V ~50/60 Hz
Material: Aluminium/Acrylic

- open cable end



Base: 1xE27 max. Ø: 6 cm | L: 11.5 cm

Options	Prod. no.
● anthracite	1006182



E27 | 8 W | 240°
880 lm | 3000 K | EEC = E
8 kW/1000h



Prod. no.: 1005289



Product	Prod. no.
Connection box IP68, 3-pole	
● black	228730



231225



1006184

GRAFIT 30

Pole, E27

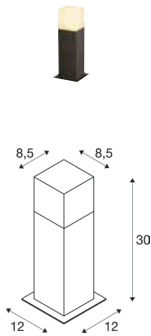

220-240 V ~50/60 Hz
Material: Aluminium/Plastic

- open cable end



Base: 1xE27 max. Ø: 6 cm | L: 11.5 cm

Options	Prod. no.
● anthracite	231215



E27 | 8 W | 320°
800 lm | 2700 K | EEC = F
8 kW/1000h



Prod. no.: 1005303



Product	Prod. no.
Connection box IP68, 3-pole	
● black	228730
Screw set	
● Stainless steel	228754
Ground spike	
● grey	231230

GRAFIT 60

Pole, E27

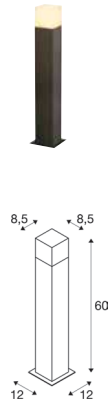

220-240 V ~50/60 Hz
Material: Aluminium/Plastic

- open cable end



Base: 1xE27 max. Ø: 6 cm | L: 11.5 cm

Options	Prod. no.
● anthracite	231225



E27 | 8 W | 240°
880 lm | 3000 K | EEC = E
8 kW/1000h



Prod. no.: 1005289



Product	Prod. no.
Connection box IP68, 3-pole	
● black	228730
Screw set	
● Stainless steel	228754
Ground spike	
● grey	231230

GRAFIT 90

Pole, E27



220-240 V ~50/60 Hz
Material: Aluminium/Acrylic

- open cable end



Base: 1xE27 max. Ø: 6 cm | L: 11.5 cm

Options	Prod. no.
● anthracite	1006184



E27 | 8 W | 240°
880 lm | 3000 K | EEC = E
8 kW/1000h



Prod. no.: 1005289



Product	Prod. no.
Connection box IP68, 3-pole	
● black	228730
Ground spike	
● grey	231230



1005442



QUADRULO FL

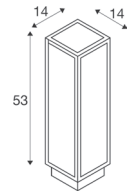

100-277 V ~50/60 Hz | 480 mA
Total wattage: 7 W
Material: Aluminium/Acrylic

- IP connection box



340lm|3000 K

Options	Prod. no.
● anthracite	1005442

RUSTY® SLOT 50 Pole

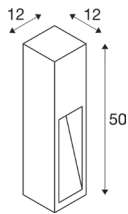

220-240 V ~50/60 Hz
 Total wattage: 9 W
 Material: FeCSi Steel/Polycarbonate (PC)

- open cable end



30 lm | 3000 K

Options	Prod. no.
● rust	233447



Product	Prod. no.
Connection box IP68, 3-pole	
● black	228730
Ground spike	
● grey	231230

RUSTY® SLOT 80 Pole

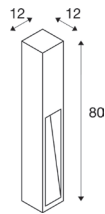

220-240 V ~50/60 Hz
 Total wattage: 9 W
 Material: FeCSi Steel/Polycarbonate (PC)

- open cable end



30 lm | 3000 K

Options	Prod. no.
● rust	233457



Product	Prod. no.
Connection box IP68, 3-pole	
● black	228730
Ground spike	
● grey	231230

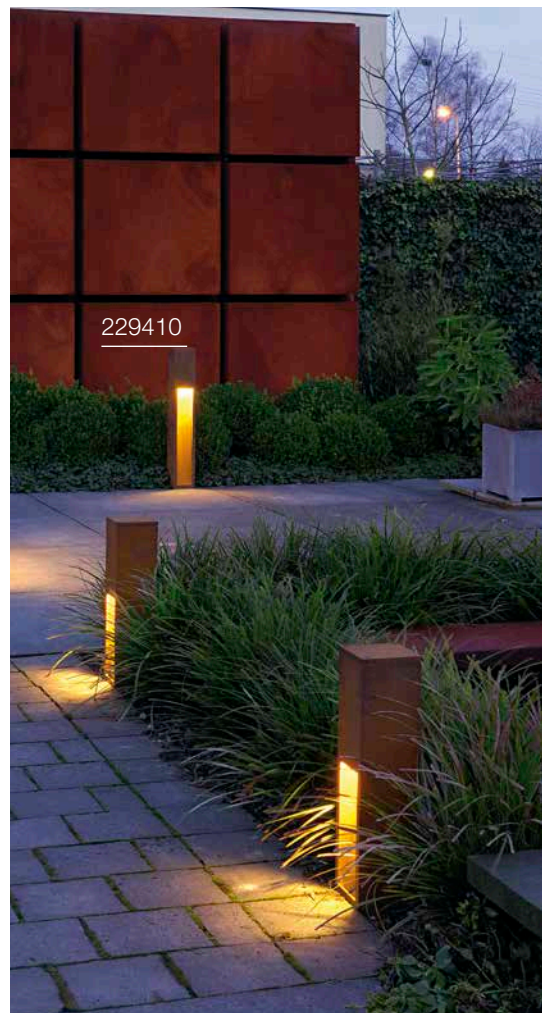
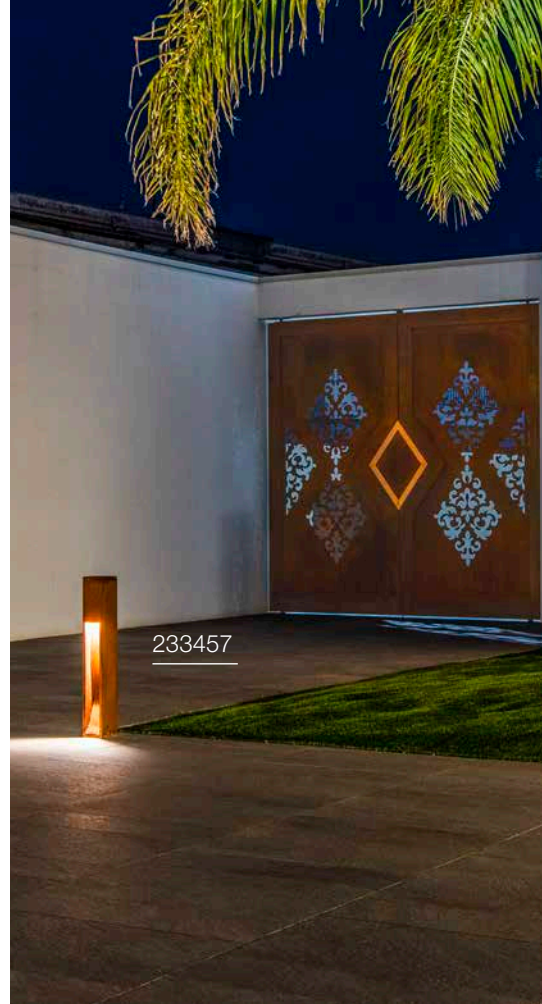



RUSTY® SLOTT 50

Pole, E27

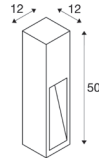

220-240 V ~50/60 Hz
Material: FeCSi Steel/Polycarbonate (PC)

- open cable end



Base: 1xE27 max. Ø: 4.8 cm | L: 13.9 cm

Options	Prod. no.
● rust	229410



E27 | 8 W | 240°
880 lm | 3000 K | EEC = E
8 kW/1000h



Prod. no.: 1005289



Product	Prod. no.
Connection box IP68, 3-pole	
● black	228730
Ground spike	
● grey	231230

RUSTY® SLOTT 80

Pole, E27

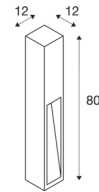

220-240 V ~50/60 Hz
Material: FeCSi Steel/Polycarbonate (PC)

- open cable end



Base: 1xE27 max. Ø: 4.8 cm | L: 13.9 cm

Options	Prod. no.
● rust	229411



E27 | 8 W | 240°
880 lm | 3000 K | EEC = E
8 kW/1000h



Prod. no.: 1005289



Product	Prod. no.
Connection box IP68, 3-pole	
● black	228730
Ground spike	
● grey	231230



229411

RUSTY® PATHLIGHT

Pole, TCR-TSE

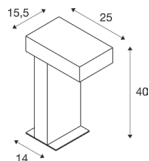

220-240 V ~50/60 Hz
Material: FeCSi Steel/Polycarbonate (PC)

- open cable end



Base: 1xG53 max. Ø: 7.5 cm | L: 2.7 cm

Options	Prod. no.
● rust	230090



GX53 | 6 W | 120°
490 lm | 2700 K | EEC = G
7 kW/1000h



Prod. no.: 1005272



Product	Prod. no.
Connection box IP68, 3-pole	
● black	228730
Ground spike	
● grey	229422

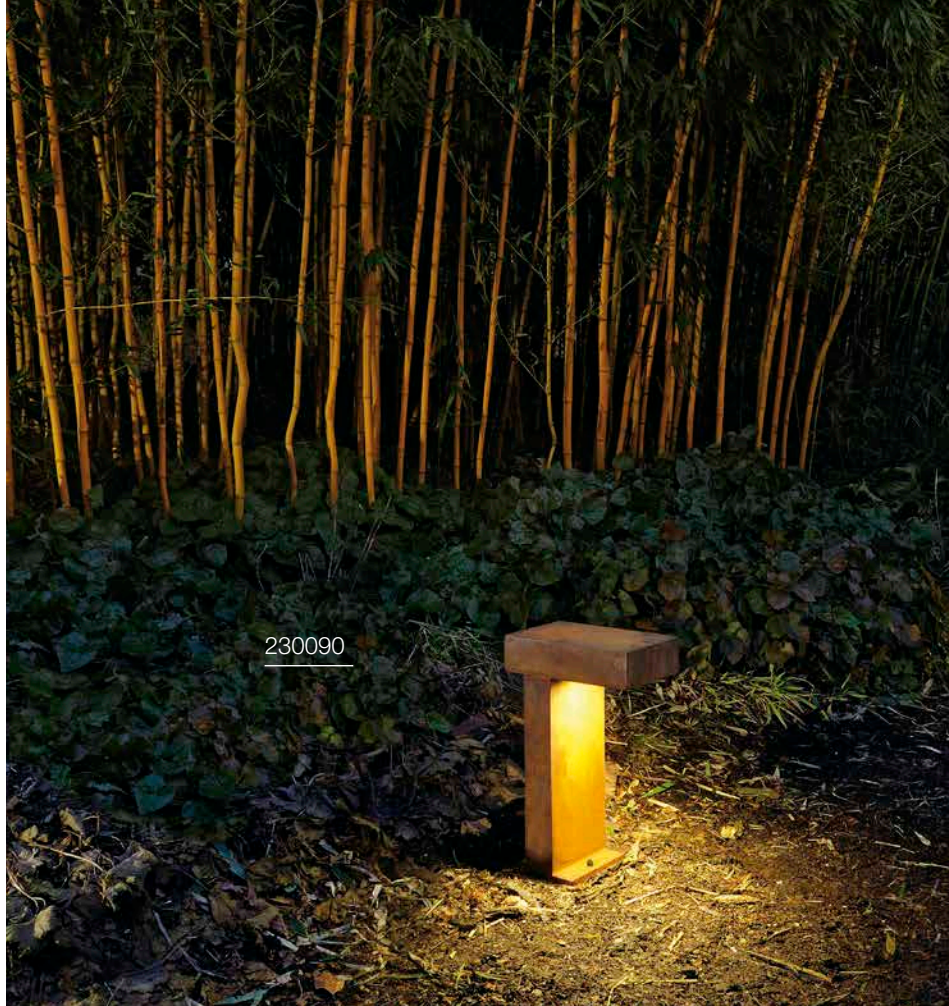



RUSTY® PATHLIGHT 40 Pole

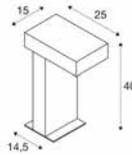

220-240 V ~50/60 Hz
Total wattage: 8.8 W
Material: Steel/Acrylic

- open cable end



470 lm|3000 K

Options	Prod. no.
● rust	1006346

RUSTY® PATHLIGHT 70 Pole

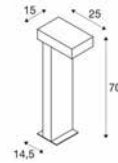

220-240 V ~50/60 Hz
Total wattage: 8.8 W
Material: Steel/Acrylic

- open cable end



470 lm|3000 K

Options	Prod. no.
● rust	1006347



1006347



Product	Prod. no.
Connection box IP68, 3-pole	
● black	228730
Ground spike	
● grey	229422



Product	Prod. no.
Connection box IP68, 3-pole	
● black	228730
Ground spike	
● grey	229422



233437

RUSTY® 40 Pole

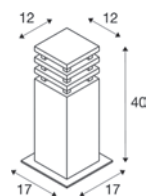

220-240 V ~50/60 Hz

Total wattage: 9 W

Material: FeCSi Steel/Polycarbonate (PC)

- open cable end



90 lm|3000 K

Options	Prod. no.
● rust	233427



229420



Product	Prod. no.
Connection box IP68, 3-pole	
● black	228730
Ground spike	
● grey	229422

RUSTY® 70

Pole

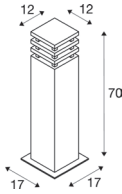

220-240 V ~50/60 Hz
Total wattage: 9 W
Material: FeCSi Steel/Polycarbonate (PC)

- open cable end



90lm|3000K

Options	Prod. no.
● rust	233437

RUSTY® 40

Pole, E27

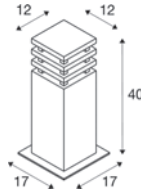

220-240 V ~50/60 Hz
Material: FeCSi Steel/Polycarbonate (PC)

- open cable end



Base: 1xE27 max. Ø: 4.8 cm | L: 13.9 cm

Options	Prod. no.
● rust	229420



E27 | 8 W | 240°
880 lm | 3000 K | EEC = E
8 kW/1000h



Prod. no.: 1005289



Product	Prod. no.
Connection box IP68, 3-pole	
● black	228730
Ground spike	
● grey	229422

RUSTY® 70

Pole, E27

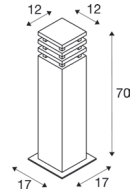

220-240 V ~50/60 Hz
Material: FeCSi Steel/Polycarbonate (PC)

- open cable end



Base: 1xE27 max. Ø: 4.8 cm | L: 13.9 cm

Options	Prod. no.
● rust	229421



E27 | 8 W | 240°
880 lm | 3000 K | EEC = E
8 kW/1000h



Prod. no.: 1005289



Product	Prod. no.
Connection box IP68, 3-pole	
● black	228730
Ground spike	
● grey	229422



229432

229430



229431

RUSTY® CONE 24 FL, E14

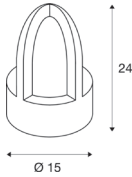

220-240 V ~50/60 Hz
Material: FeCSi Steel/Glass

- open cable end



Base: 1xE14 max. Ø: 4.8 cm | L: 13.9 cm

Options	Prod. no.
● rust	229430



E14 | 4 W | 320°
380 lm | 2700 K | EEC = F
5 kW/1000h

Prod. no.: 1005284



RUSTY® CONE 40 Pole, E27

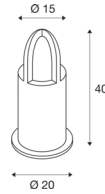

220-240 V ~50/60 Hz
Material: FeCSi Steel/Glass

- open cable end



Base: 1xE27 max. Ø: 4.8 cm | L: 13.9 cm

Options	Prod. no.
● rust	229431



E27 | 8 W | 240°
880 lm | 3000 K | EEC = E
8 kW/1000h

Prod. no.: 1005289



Product	Prod. no.
Connection box IP68, 3-pole	
● black	228730
Ground spike	
● grey	229423

RUSTY® CONE 70 Pole, E27

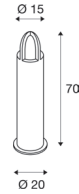

220-240 V ~50/60 Hz
Material: FeCSi Steel/Polycarbonate (PC)

- open cable end



Base: 1xE27 max. Ø: 4.8 cm | L: 13.9 cm

Options	Prod. no.
● rust	229432



E27 | 8 W | 240°
880 lm | 3000 K | EEC = E
8 kW/1000h

Prod. no.: 1005289



Product	Prod. no.
Connection box IP68, 3-pole	
● black	228730
Ground spike	
● grey	229423

RUSTY® 40
Pole, E27

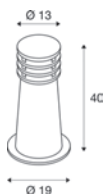

220-240 V ~50/60 Hz
Material: FeCSi Steel/Polycarbonate (PC)

- open cable end



Base: 1xE27 max. Ø: 4.8 cm L: 13.9 cm

Options	Prod. no.
● rust	229020



E27 | 8 W | 240°
880 lm | 3000 K | EEC = E
8 kW/1000h



Prod. no.: 1005289



Product	Prod. no.
Connection box IP68, 3-pole	
● black	228730
Ground spike	
● Stainless steel	229022

RUSTY® 70
Pole, E27



220-240 V ~50/60 Hz
Material: FeCSi Steel/Polycarbonate (PC)

- open cable end



Base: 1xE27 max. Ø: 4.8 cm L: 13.9 cm

Options	Prod. no.
● rust	229021



E27 | 8 W | 240°
880 lm | 3000 K | EEC = E
8 kW/1000h



Prod. no.: 1005289



Product	Prod. no.
Connection box IP68, 3-pole	
● black	228730
Ground spike	
● Stainless steel	229022



229020

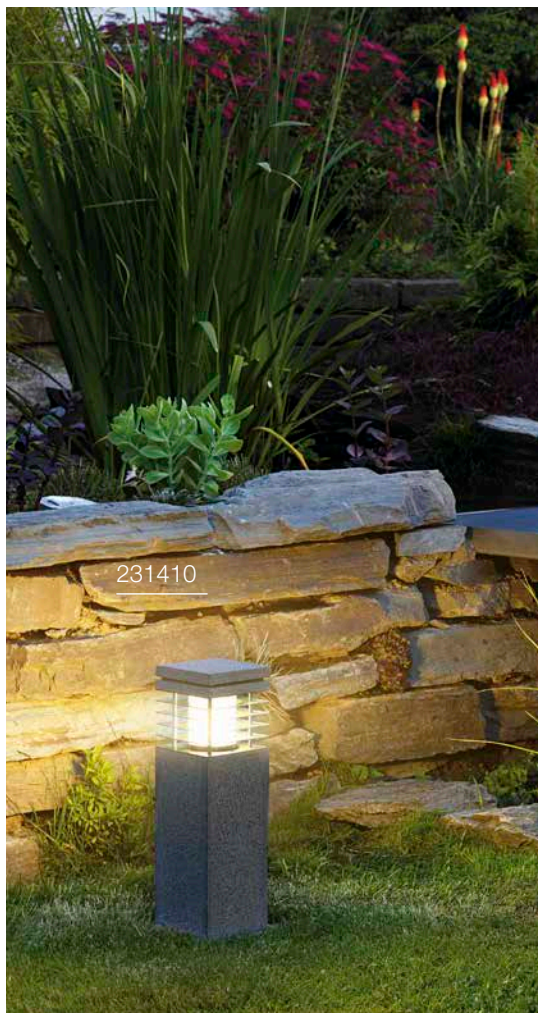

231410

ARROCK GRANITE 40

Pole, square, E27

ARROCK GRANITE 70

Pole, square, E27



229021

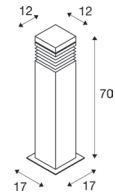
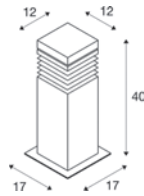

220-240 V ~50/60 Hz
Material: Granite/Stainless steel 304

220-240 V ~50/60 Hz
Material: Granite/Stainless steel 304

- open cable end

- open cable end



Base: 1xE27 max. Ø: 5.2 cm | L: 11.5 cm

Base: 1xE27 max. Ø: 5.2 cm | L: 11.5 cm

Options	Prod. no.
●● grey/chrome	231410

Options	Prod. no.
●● grey/chrome	231411



E27 | 8 W | 240°
880 lm | 3000 K | EEC = E
8 kW/1000h



Prod. no.: 1005289



E27 | 8 W | 240°
880 lm | 3000 K | EEC = E
8 kW/1000h



Prod. no.: 1005289



Product	Prod. no.
Connection box IP68, 3-pole	
● black	228730
Ground spike	
● grey	229422



Product	Prod. no.
Connection box IP68, 3-pole	
● black	228730
Ground spike	
● grey	229422



ARROCK ARC

Pole, QPAR51

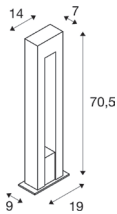

220-240 V ~50/60 Hz
Material: Granite/Stainless steel 304



Base: 1xGU10 max. Ø: 5.1 cm | L: 7.6 cm

Options	Prod. no.
●● grey/chrome	231420



GU10 | 6 W | 38°
450 lm | 2700 K | EEC = F
6 kW/1000h



Prod. no.: 1005077



Product	Prod. no.
Ground spike	
● grey	231233



231420



231371



231440

ARROCK STONE 50 Pole

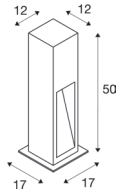

220-240 V ~50/60 Hz | 700 mA
Total wattage: 9 W
Material: Basalt/Stainless steel 304

- IP connection box
- open cable end



330 lm | 3000 K

Options	Prod. no.
● grey	231370

ARROCK STONE 75 Pole

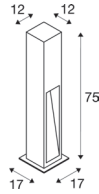

220-240 V ~50/60 Hz | 700 mA
Total wattage: 9 W
Material: Basalt/Stainless steel 304

- IP connection box
- open cable end



330 lm | 3000 K

Options	Prod. no.
● grey	231371

ARROCK SLOT Pole, QPAR51

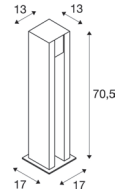

220-240 V ~50/60 Hz
Material: Granite/Stainless steel 304

- open cable end



Base: 1xGU10

Options	Prod. no.
●● grey/chrome	231440



GU10 | 6 W | 38°
450 lm | 2700 K | EEC = F
6 kW/10000h



Prod. no.: 1005077



Product	Prod. no.
Ground spike	
● grey	231235



Product	Prod. no.
Ground spike	
● grey	231235



Product	Prod. no.
Connection box IP68, 3-pole	
● black	228730
Ground spike	
● grey	231235



L-LINE OUT 30 FL, vertical

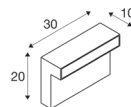

220-240 V ~50/60 Hz | 500 mA
 Total wattage: 11.5W
 Material: Aluminium/Polycarbonate (PC)

- The light colour must be set prior to installation
- open cable end



800lm|3000 K | 810lm|4000 K

Options	Prod. no.
● anthracite	1003536



Product	Prod. no.
Connection box IP68, 3-pole	
● black	228730

L-LINE OUT 60

FL, vertical

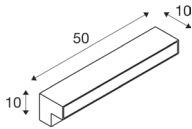

220-240 V ~50/60 Hz | 500 mA
Total wattage: 11.5 W
Material: Aluminium/Polycarbonate (PC)

- The light colour must be set prior to installation
- open cable end



780 lm | 3000 K | 800 lm | 4000 K

Options	Prod. no.
● anthracite	1003535



Product	Prod. no.
Connection box IP68, 3-pole	
● black	228730

L-LINE OUT 50

Pole, horizontal

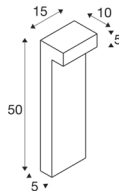

220-240 V ~50/60 Hz | 350 mA
Total wattage: 7 W
Material: Aluminium/Polycarbonate (PC)

- The light colour must be set prior to installation
- open cable end



490 lm | 3000 K | 530 lm | 4000 K

Options	Prod. no.
● anthracite	1003537



Product	Prod. no.
Connection box IP68, 3-pole	
● black	228730

L-LINE OUT 80

Pole, horizontal

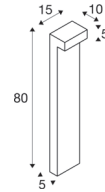

220-240 V ~50/60 Hz | 350 mA
Total wattage: 7 W
Material: Aluminium/Polycarbonate (PC)

- The light colour must be set prior to installation
- open cable end



490 lm | 3000 K | 530 lm | 4000 K

Options	Prod. no.
● anthracite	1003538



Product	Prod. no.
Connection box IP68, 3-pole	
● black	228730



TAHA II 45 Pole, PHASE

TAHA II 70 Pole, Sensor

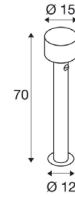
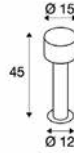

220-240 V ~50/60 Hz | 240 mA
Total wattage: 10 W
Material: Aluminium

- IP connection box



100-240 V ~50/60 Hz | 240 mA
Total wattage: 10 W
Material: Aluminium

- Primary and replica functionality. Option to control additional lights without a sensor
- IP connection box



450lm|2200 K | 500lm|2700 K

Options	Prod. no.
● black	1010197 ●
● black	1010198 ●
● black	1010199 ●



450lm|2200 K | 500lm|2700 K

Options	Prod. no.
● black	1010200 ●
● black	1010201 ●



1004680



OVALISK 75 Pole

OVALISK 100 Pole

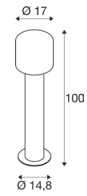
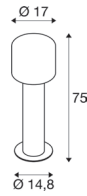

220-240 V ~50/60 Hz | 500 mA
Total wattage: 6 W
Material: Aluminium/Glass

220-240 V ~50/60 Hz | 500 mA
Total wattage: 6 W
Material: Aluminium/Glass

- The light colour must be set prior to installation
- open cable end

- The light colour must be set prior to installation
- open cable end



580 lm | 3000 K | 630 lm | 4000 K



580 lm | 3000 K | 630 lm | 4000 K

Options	Prod. no.
● anthracite	1004680

Options	Prod. no.
● anthracite	1004681



Product	Prod. no.
Concrete anchor	
○ silver	228712
Ground spike	
● grey	228722
Connection box IP68, 3-pole	
● black	228730



Product	Prod. no.
Concrete anchor	
○ silver	228712
Ground spike	
● grey	228722
Connection box IP68, 3-pole	
● black	228730



1001999

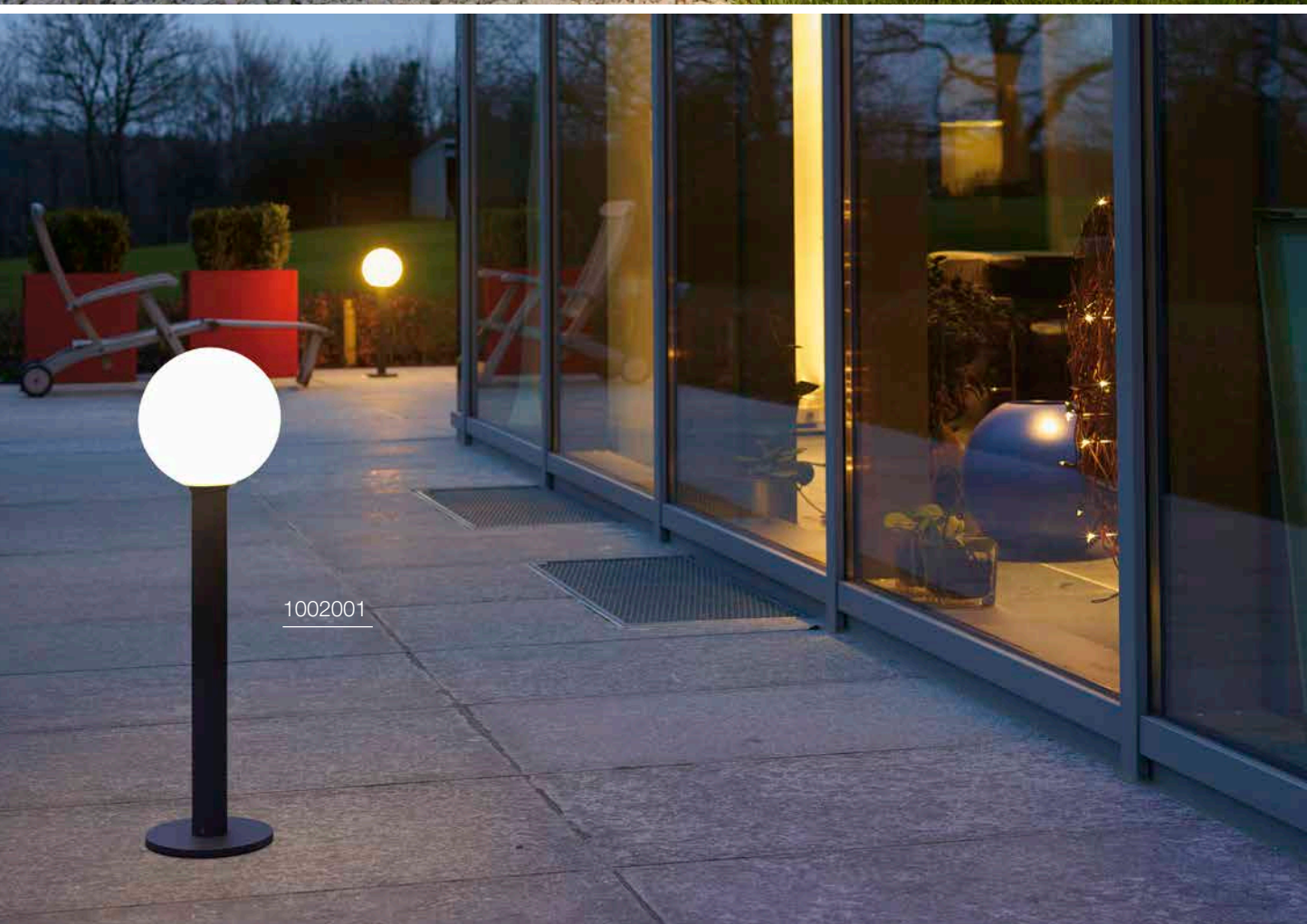

1002001

GLOO PURE 27

Pole, E27

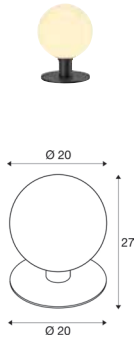

220-240 V ~50/60 Hz
Material: Aluminium/Glass

- open cable end



Base: 1xE27 max. Ø: 4.8 cm | L: 18 cm

Options	Prod. no.
● anthracite	1001999



E27 | 8 W | 240°
880 lm | 3000 K | EEC = E
8 kW/1000h



Prod. no.: 1005289



Product	Prod. no.
Connection box IP68, 3-pole	
● black	228730
Ground spike	
● grey	231234

GLOO PURE 44

Pole, E27

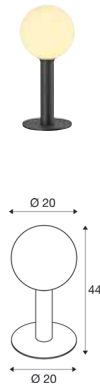

220-240 V ~50/60 Hz
Material: Aluminium/Glass

- open cable end



Base: 1xE27 max. Ø: 4.8 cm | L: 18 cm

Options	Prod. no.
● anthracite	1002000



E27 | 14 W | 240°
1520 lm | 3000 K | EEC = E
14 kW/1000h



Prod. no.: 1005307



Product	Prod. no.
Connection box IP68, 3-pole	
● black	228730
Ground spike	
● grey	231234

GLOO PURE 70

Pole, E27



220-240 V ~50/60 Hz
Material: Aluminium/Glass

- open cable end



Base: 1xE27 max. Ø: 4.8 cm | L: 18 cm

Options	Prod. no.
● anthracite	1002001



E27 | 8 W | 240°
880 lm | 3000 K | EEC = E
8 kW/1000h



Prod. no.: 1005289



Product	Prod. no.
Connection box IP68, 3-pole	
● black	228730
Ground spike	
● grey	231234



227221

ROTOBALL 25 FL, E27

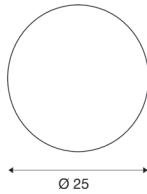

220-240 V ~50/60 Hz
Material: Steel/Polyethylene (PE)

- IP44 safety plug



Base: 1xE27

Options	Prod. no.
<input type="radio"/> white	227219



E27 | 13 W | 220°
1300lm | 2700 K | EEC = F
14 kW/1000h



Prod. no.: 1005302

ROTOBALL 40 FL, E27

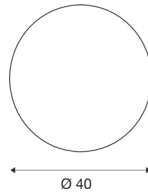

220-240 V ~50/60 Hz
Material: Steel/Polyethylene (PE)

- IP44 safety plug



Base: 1xE27 max. Ø: 9.5 cm

Options	Prod. no.
<input type="radio"/> white	227220



E27 | 13 W | 220°
1300lm | 2700 K | EEC = F
14 kW/1000h



Prod. no.: 1005302

ROTOBALL 50 FL, E27

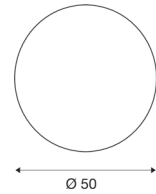

220-240 V ~50/60 Hz
Material: Steel/Polyethylene (PE)

- IP44 safety plug



Base: 1xE27 max. Ø: 9.5 cm

Options	Prod. no.
<input type="radio"/> white	227221



E27 | 13 W | 220°
1300lm | 2700 K | EEC = F
14 kW/1000h



Prod. no.: 1005302



232075

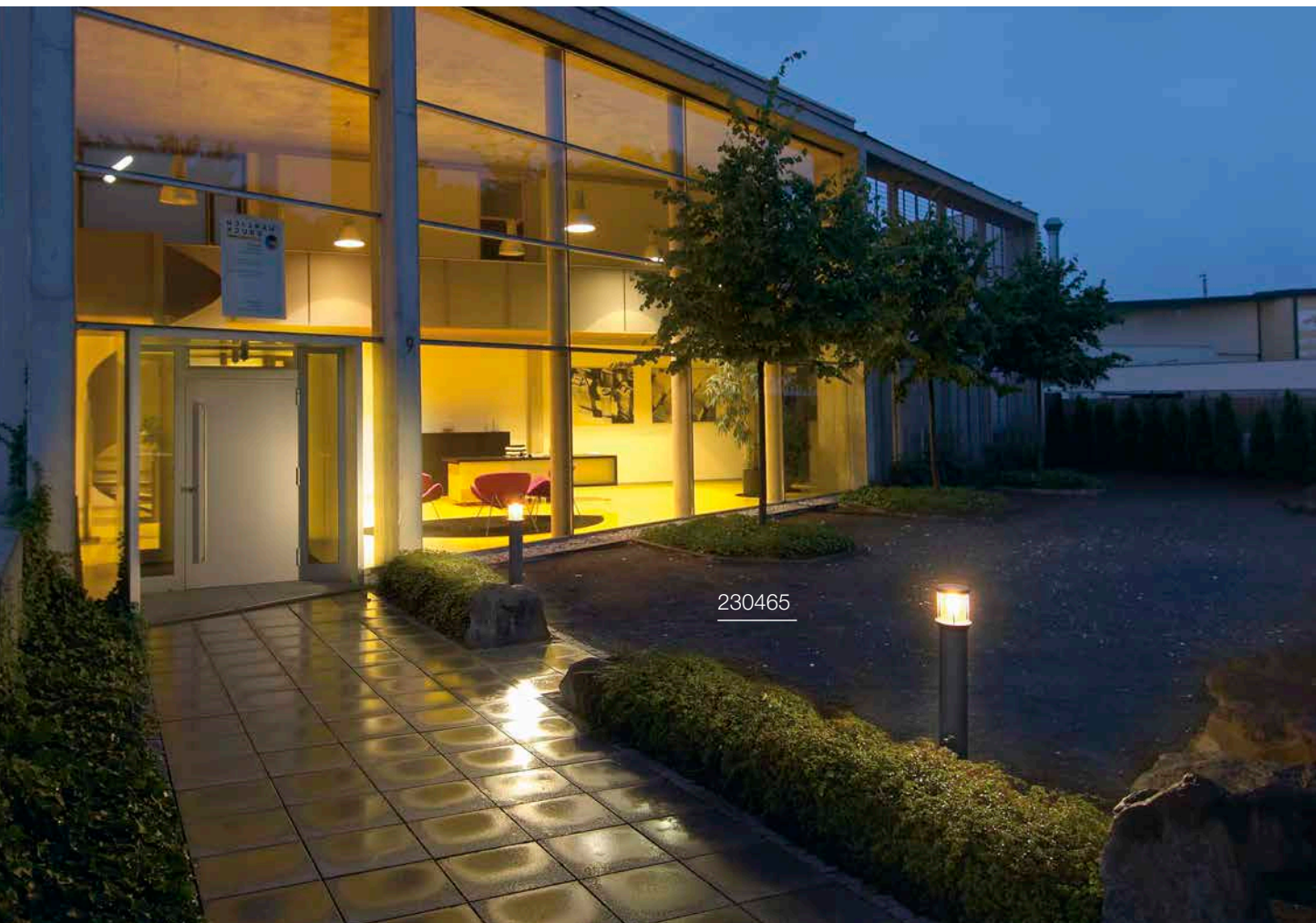

230465

PHOTONIA

Pole, E27



220-240 V ~50/60 Hz
Material: Aluminium/Glass

- open cable end



Base: 1xE27 max. Ø: 9 cm | L: 15 cm

Options	Prod. no.
● anthracite	232075



E27 | 8 W | 320°
800 lm | 2700 K | EEC = F
8 kW/1000h



Prod. no.: **1005303**



Product	Prod. no.
Connection box IP68, 3-pole	
● black	228730
Concrete anchor	
● Stainless steel	232085

OTOS GLAS

Pole, E27

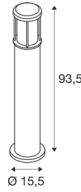

220-240 V ~50/60 Hz
Material: Aluminium/Glass

- Concrete anchor included



Base: 1xE27 max. Ø: 6.5 cm | L: 14.5 cm

Options	Prod. no.
● anthracite	230465



E27 | 13 W | 220°
1300 lm | 2700 K | EEC = F
14 kW/1000h



Prod. no.: **1005302**



Product	Prod. no.
Connection box IP68, 3-pole	
● black	228730
Screw set	
● Stainless steel	228753

CUBIX
FL, QPAR51

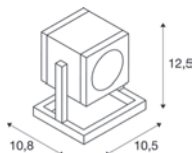

220-240 V ~50/60 Hz
Material: Aluminium/Glass

- IP44 safety plug



Base: 1xGU10

Options	Prod. no.
● anthracite	132835

GU10 | 6 W | 38°
450lm | 2700 K | EEC = F
6 kW/1000h

Prod. no.: 1005077



CONE
FL, E27

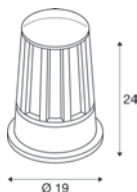

220-240 V ~50/60 Hz
Material: Aluminium/Glass



Base: 1xE27

L: 15 cm

Options	Prod. no.
● anthracite	230435

E27 | 13 W | 220°
1300lm | 2700 K | EEC = F
14 kW/1000h

Prod. no.: 1005302

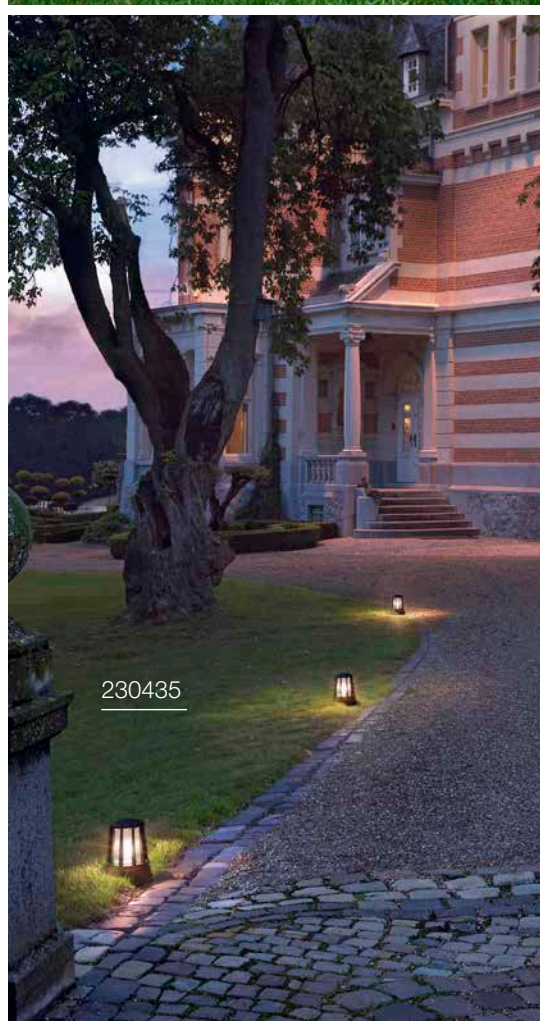
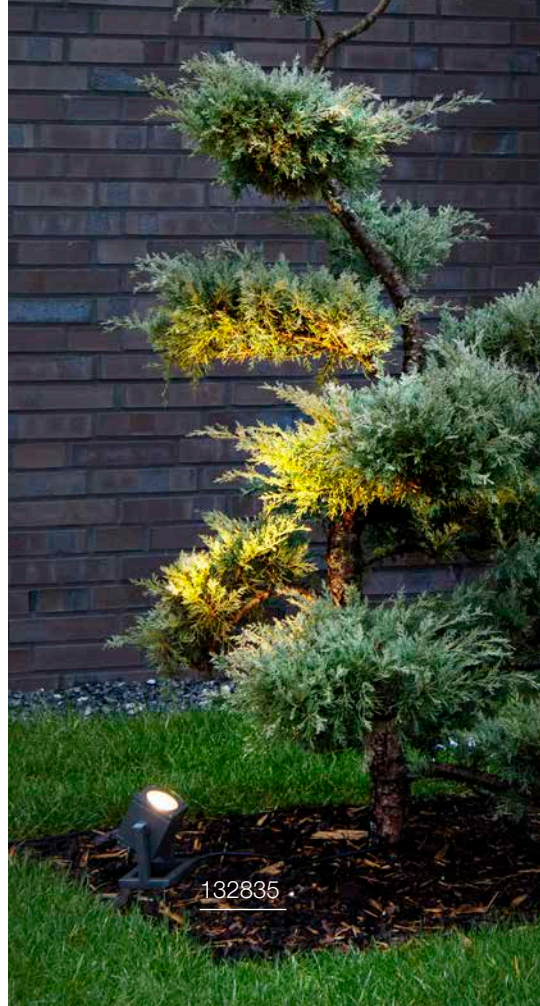



1000821

MOLAT PD, E27

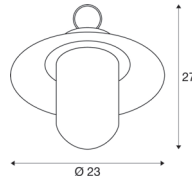

220-240 V ~50/60 Hz
Material: Aluminium/Glass

- Suspension chain included
- IP44 safety plug



Base: 1xE27 max. Ø: 6.5 cm L: 14.5 cm

Options	Prod. no.
● anthracite	1000821



E27 | 8 W | 320°
800 lm | 2700 K | EEC = F
8 kW/1000h

Prod. no.: 1005268



Product	Prod. no.
Ceiling rosette	
● anthracite	1000398

MOLAT 100 Pole, E27

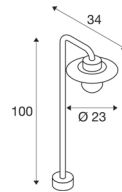

220-240 V ~50/60 Hz
Material: Aluminium/Glass

- open cable end



Base: 1xE27 max. Ø: 6.5 cm L: 14.5 cm

Options	Prod. no.
● anthracite	1000822



E27 | 8 W | 320°
700 lm | 2500 K | EEC = F
8 kW/1000h

Prod. no.: 1005265



Product	Prod. no.
Ground spike	
● grey	230060



1000822

LISENNE 40

Pole, E27

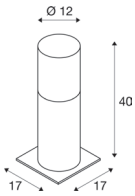

220-240 V ~50/60 Hz
Material: Basalt/Glass

- open cable end



Base: 1xE27 max. Ø: 5.9 cm L: 15 cm

Options	Prod. no.
● grey	1000665



E27 | 8W | 320°
800lm | 2700K | EEC = F
8kW/1000h



Prod. no.: 1005268



Product	Prod. no.
Ground spike	
● grey	229422



1000665





LISENNE 70

Pole, E27

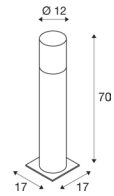

220-240 V ~50/60 Hz
Material: Basalt/Glass

- open cable end



Base: 1xE27 max. Ø: 5.9 cm L: 15 cm

Options	Prod. no.
● grey	1000666



E27 | 8 W | 320°
800 lm | 2700 K | EEC = F
8 kW/1000h



Prod. no.: 1005268



Product	Prod. no.
Ground spike	
● grey	229422



1000666



228935



228925



ALPHA MUSHROOM 45

Pole, E27

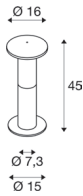

220-240 V ~50/60 Hz
Material: Aluminium/Polycarbonate (PC)

- open cable end



Base: 1xE27 max. Ø: 5.2 cm | L: 16 cm

Options	Prod. no.
● anthracite	228935



E27 | 14 W | 240°
1520 lm | 3000 K | EEC = E
14 kW/1000h



Prod. no.: 1005307



Product	Prod. no.
Concrete anchor	
○ silver	228712
Ground spike	
● grey	228722
Connection box IP68, 3-pole	
● black	228730
Screw set	
● Stainless steel	228752

ALPHA MUSHROOM 75

Pole, E27

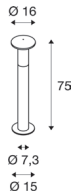
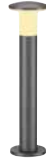

220-240 V ~50/60 Hz
Material: Aluminium/Polycarbonate (PC)

- open cable end



Base: 1xE27 max. Ø: 5.2 cm | L: 16 cm

Options	Prod. no.
● anthracite	228945



E27 | 14 W | 240°
1520 lm | 3000 K | EEC = E
14 kW/1000h



Prod. no.: 1005307



Product	Prod. no.
Concrete anchor	
○ silver	228712
Ground spike	
● grey	228722
Connection box IP68, 3-pole	
● black	228730
Screw set	
● Stainless steel	228752

ALPHA CONE 100

Pole, E27

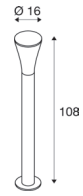

220-240 V ~50/60 Hz
Material: Aluminium/Polycarbonate (PC)

- open cable end



Base: 1xE27 max. Ø: 5.2 cm | L: 17.5 cm

Options	Prod. no.
● anthracite	228925



E27 | 8 W | 240°
880 lm | 3000 K | EEC = E
8 kW/1000h



Prod. no.: 1005289



Product	Prod. no.
Concrete anchor	
○ silver	228712
Ground spike	
● grey	228722
Connection box IP68, 3-pole	
● black	228730
Screw set	
● Stainless steel	228752

APONI 90
Pole, PHASE

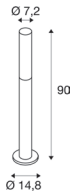

220-240 V ~50/60 Hz | 500 mA
Total wattage: 6.3 W
Material: Aluminium

- open cable end



520 lm | 3000 K

Options	Prod. no.
● anthracite	1000682



Product	Prod. no.
Connection box IP68, 3-pole	
● black	228730

APONI 120
Pole, PHASE

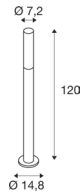

220-240 V ~50/60 Hz | 500 mA
Total wattage: 6.3 W
Material: Aluminium

- open cable end



520 lm | 3000 K

Options	Prod. no.
● anthracite	1000683



Product	Prod. no.
Connection box IP68, 3-pole	
● black	228730

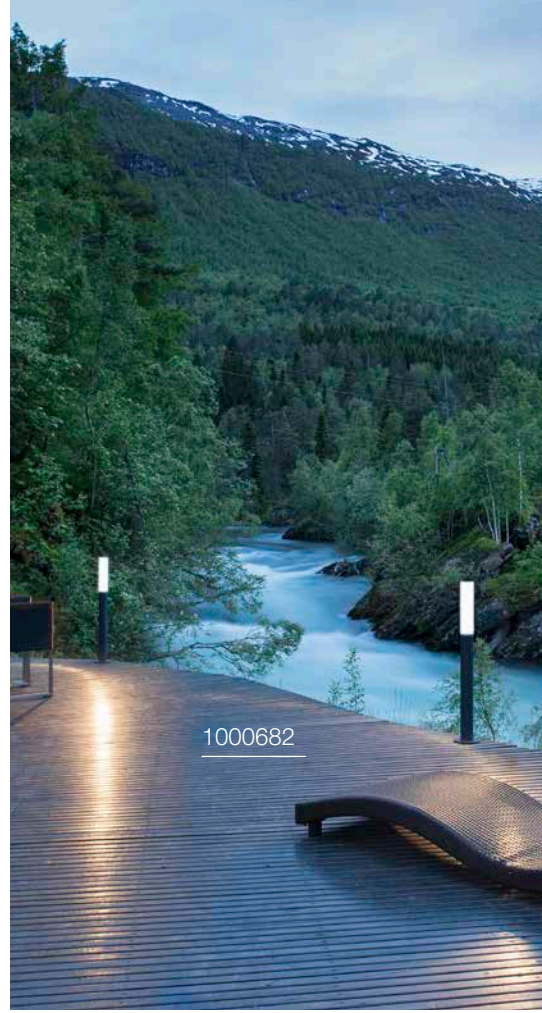



TRUST 30 Pole

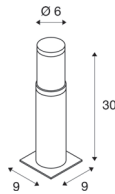

220-240 V ~50/60 Hz
Total wattage: 9 W
Material: Stainless steel 316

- open cable end



400lm|3000 K

Options	Prod. no.
● Stainless steel	228100



Product	Prod. no.
Ground spike	
● black	227922
Ring-shaped grid	
● Stainless steel	228130
Connection box IP68, 3-pole	
● black	228730
Spiral-shaped grid	
● black	1000449

TRUST 60 Pole

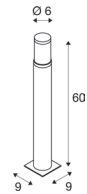

220-240 V ~50/60 Hz
Total wattage: 9 W
Material: Stainless steel 316

- open cable end



400lm|3000 K

Options	Prod. no.
● Stainless steel	228110



Product	Prod. no.
Ground spike	
● black	227922
Ring-shaped grid	
● Stainless steel	228130
Connection box IP68, 3-pole	
● black	228730
Spiral-shaped grid	
● black	1000449



228110

BIG NAILS 50

Pole, E27



220-240 V ~50/60 Hz
Material: Stainless steel 304/
Polycarbonate (PC)

- open cable end



Base: 1xE27 max. Ø: 4.5 cm | L: 17 cm

Options	Prod. no.
● Stainless steel	229162



E27 | 8 W | 240°
880 lm | 3000 K | EEC = E
8 kW/1000h



Prod. no.: **1005289**



Product	Prod. no.
Ground spike	
● black	227922

BIG NAILS 80

Pole, E27



220-240 V ~50/60 Hz
Material: Stainless steel 304/
Polycarbonate (PC)

- open cable end



Base: 1xE27 max. Ø: 4.5 cm | L: 17 cm

Options	Prod. no.
● Stainless steel	229172



E27 | 8 W | 240°
880 lm | 3000 K | EEC = E
8 kW/1000h



Prod. no.: **1005289**



Product	Prod. no.
Ground spike	
● black	227922

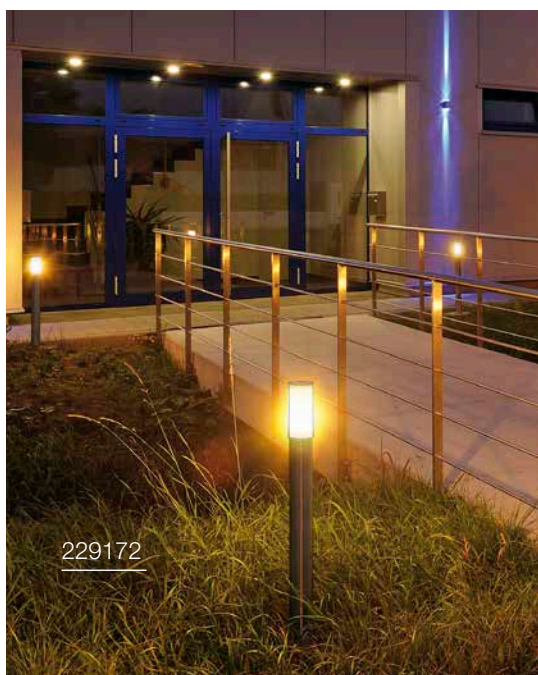

ROX ACRYL 30

Pole, E27

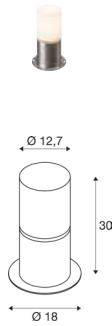

220-240 V ~50/60 Hz
Material: Stainless steel 304

- open cable end



Base: 1xE27 max. Ø: 6 cm | L: 15 cm

Options	Prod. no.
● Stainless steel	1001488



E27 | 4 W | 280°
830 lm | 2700 K | EEC = A
4 kW/1000h

Prod. no.: 1008641



Product	Prod. no.
T-connector box	
● black	228726
Ground spike	
● grey	231234
Concrete anchor	
● Stainless steel	1001494

ROX ACRYL 60

Pole, E27



220-240 V ~50/60 Hz
Material: Stainless steel 304

- open cable end



Base: 1xE27 max. Ø: 6 cm | L: 15 cm

Options	Prod. no.
● Stainless steel	1001489



E27 | 13 W | 220°
1300 lm | 2700 K | EEC = F
14 kW/1000h

Prod. no.: 1005302



Product	Prod. no.
T-connector box	
● black	228726
Ground spike	
● grey	231234
Concrete anchor	
● Stainless steel	1001494

ROX ACRYL 90

Pole, E27

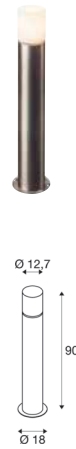

220-240 V ~50/60 Hz
Material: Stainless steel 304

- open cable end



Base: 1xE27 max. Ø: 6 cm | L: 15 cm

Options	Prod. no.
● Stainless steel	1001490



E27 | 8 W | 320°
800 lm | 2700 K | EEC = F
8 kW/1000h

Prod. no.: 1005303



Product	Prod. no.
T-connector box	
● black	228726
Ground spike	
● grey	231234
Concrete anchor	
● Stainless steel	1001494



230066



230069

VAP SLIM 30

Pole, E27

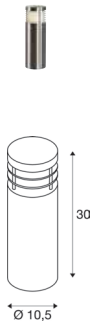

220-240 V ~50/60 Hz
Material: Stainless steel 304

- open cable end



Base: 1xE27 max. Ø: 5.1 cm | L: 12.6 cm

Options	Prod. no.
● Stainless steel	230063



E27 | 8 W | 240°
880 lm | 3000 K | EEC = E
8 kW/1000h



Prod. no.: **1005289**



Product	Prod. no.
Ground spike	
● grey	230060
Concrete anchor	
● Stainless steel	230061

VAP SLIM 60

Pole, E27



220-240 V ~50/60 Hz
Material: Stainless steel 304

- open cable end



Base: 1xE27 max. Ø: 5.1 cm | L: 12.6 cm

Options	Prod. no.
● Stainless steel	230066



E27 | 8 W | 240°
880 lm | 3000 K | EEC = E
8 kW/1000h



Prod. no.: **1005289**



Product	Prod. no.
Ground spike	
● grey	230060
Concrete anchor	
● Stainless steel	230061

VAP SLIM 90

Pole, E27



220-240 V ~50/60 Hz
Material: Stainless steel 304

- open cable end



Base: 1xE27 max. Ø: 5.1 cm | L: 12.6 cm

Options	Prod. no.
● Stainless steel	230069



E27 | 8 W | 240°
880 lm | 3000 K | EEC = E
8 kW/1000h



Prod. no.: **1005289**



Product	Prod. no.
Ground spike	
● grey	230060
Concrete anchor	
● Stainless steel	230061

C-POL 90
Pole, E27

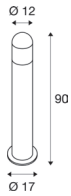

220-240 V ~50/60 Hz
Material: Aluminium/Polycarbonate (PC)

- open cable end



Base: 1xE27 max. Ø: 5.2 cm | L: 17.3 cm

Options	Prod. no.
● anthracite	231475



E27 | 8 W | 240°
880 lm | 3000 K | EEC = E
8 kW/1000h



Prod. no.: **1005289**



Product	Prod. no.
Connection box IP68, 3-pole	
● black	228730

F-POL 85
Pole, E27

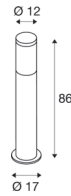

220-240 V ~50/60 Hz
Material: Aluminium/Polycarbonate (PC)

- open cable end



Base: 1xE27 max. Ø: 5.1 cm | L: 14.8 cm

Options	Prod. no.
● anthracite	231595



E27 | 8 W | 240°
880 lm | 3000 K | EEC = E
8 kW/1000h



Prod. no.: **1005289**



Product	Prod. no.
Connection box IP68, 3-pole	
● black	228730

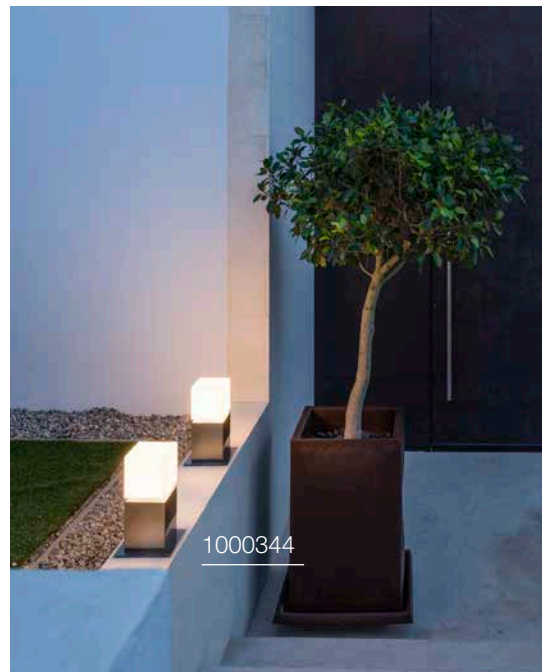
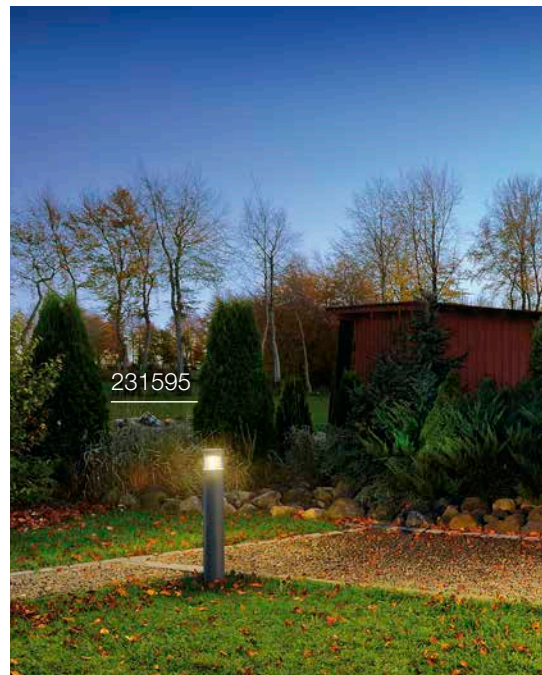
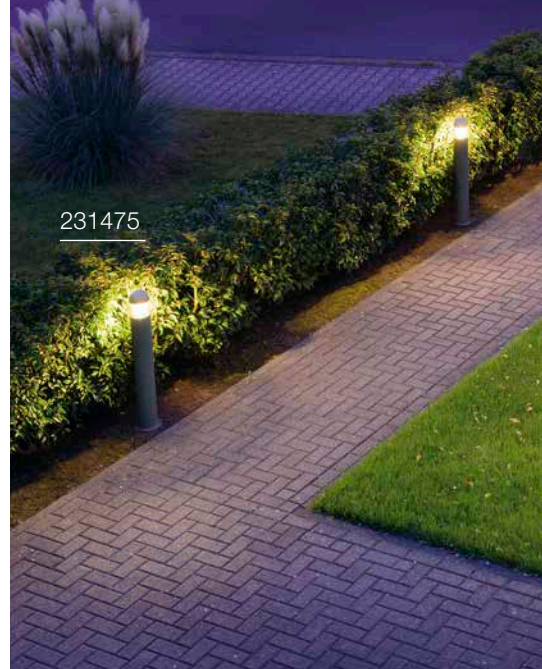

SQUARE POLE 30

Pole, E27

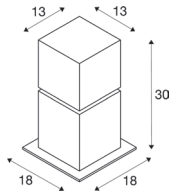

220-240 V ~50/60 Hz
Material: Stainless steel 304

- open cable end



Base: 1xE27 max. Ø: 6 cm | L: 15 cm

Options	Prod. no.
● Stainless steel	1000344



E27 | 8 W | 320°
800 lm | 2700 K | EEC = F
8 kW/1000h



Prod. no.: 1005303



Product	Prod. no.
Connection box IP68, 3-pole	
● black	228730
Ground spike	
● grey	231234
Concrete anchor	
● Stainless steel	1000343

SQUARE POLE 60

Pole, E27

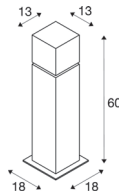

220-240 V ~50/60 Hz
Material: Stainless steel 304

- open cable end



Base: 1xE27 max. Ø: 6 cm | L: 15 cm

Options	Prod. no.
● Stainless steel	1000345



E27 | 4 W | 280°
830 lm | 2700 K | EEC = A
4 kW/1000h



Prod. no.: 1008641



Product	Prod. no.
Connection box IP68, 3-pole	
● black	228730
Ground spike	
● grey	231234
Concrete anchor	
● Stainless steel	1000343

SQUARE POLE 90

Pole, E27

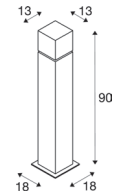

220-240 V ~50/60 Hz
Material: Stainless steel 304

- open cable end



Base: 1xE27 max. Ø: 6 cm | L: 15 cm

Options	Prod. no.
● Stainless steel	1000346



E27 | 13 W | 220°
1300 lm | 2700 K | EEC = F
14 kW/1000h



Prod. no.: 1005302



Product	Prod. no.
Connection box IP68, 3-pole	
● black	228730
Ground spike	
● grey	231234
Concrete anchor	
● Stainless steel	1000343



231455



SLOTS 45 Pole

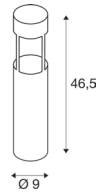

220-240 V ~50/60 Hz
Total wattage: 4.5 W
Material: Aluminium

- Concrete anchor included
- open cable end



200lm|3000 K

Options	Prod. no.
● anthracite	231815
● rust	231817

SLOTS 65 Pole

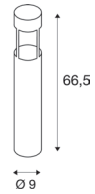

220-240 V ~50/60 Hz
Total wattage: 4.5 W
Material: Aluminium

- Concrete anchor included
- open cable end



200lm|3000 K

Options	Prod. no.
● anthracite	231455
● rust	231457

H-POL 30 Pole

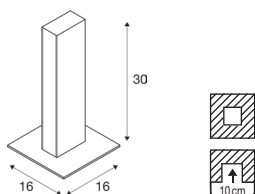

100-277 V ~50/60 Hz | 480 mA

Total wattage: 9.7 W

Material: Aluminium/Plastic

- This product is intended for in-floor installation
- A larger recessed fixing kit is available for optional installation in the floor, with installation dimensions L: 14 cm W: 14 cm D: 16 cm



350lm|3000 K

Options

Prod. no.

- anthracite

232155



Product

Prod. no.

Recessed fixing kit 14x14 cm

- black

232195

H-POL 60 Pole

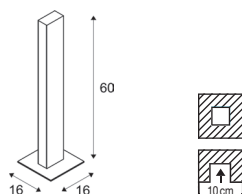

100-277 V ~50/60 Hz | 500 mA

Total wattage: 18 W

Material: Aluminium/Plastic

- This product is intended for in-floor installation
- A larger recessed fixing kit is available for optional installation in the floor, with installation dimensions L: 14 cm W: 14 cm D: 16 cm



700lm|3000 K

Options

Prod. no.

- anthracite

232165



Product

Prod. no.

Recessed fixing kit 14x14 cm

- black

232195

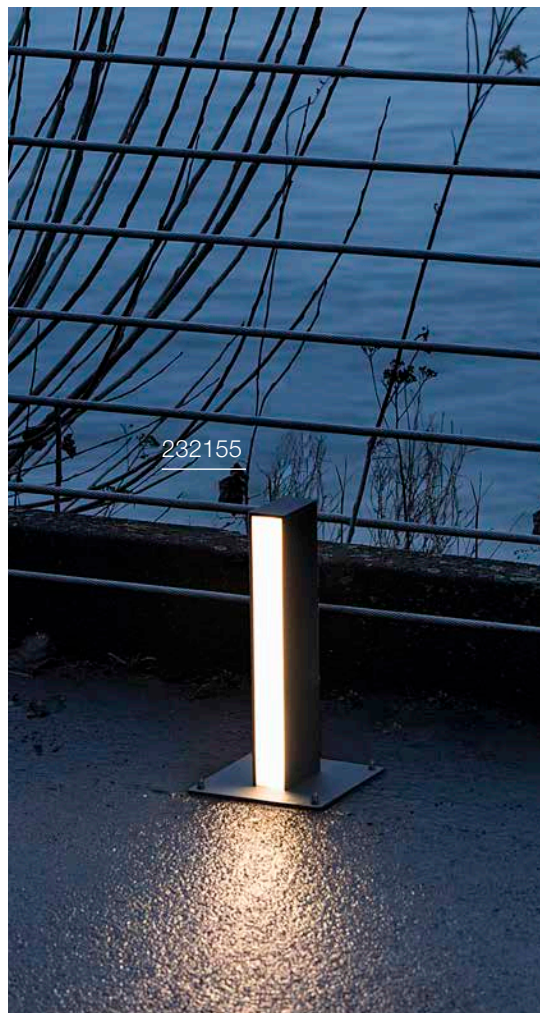

232155



H-POL TWIN 60 Pole



232165

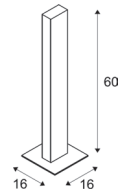

220-240 V ~50/60 Hz | 1000 mA

Total wattage: 35 W

Material: Aluminium/Plastic

- This product is intended for in-floor installation
- A larger recessed fixing kit is available for optional installation in the floor, with installation dimensions L: 14 cm W: 14 cm D: 16 cm



Direct

700lm|3000 K

Options	Prod. no.
● anthracite	232185



Product	Prod. no.
Recessed fixing kit 14x14 cm	
● black	232195



232135

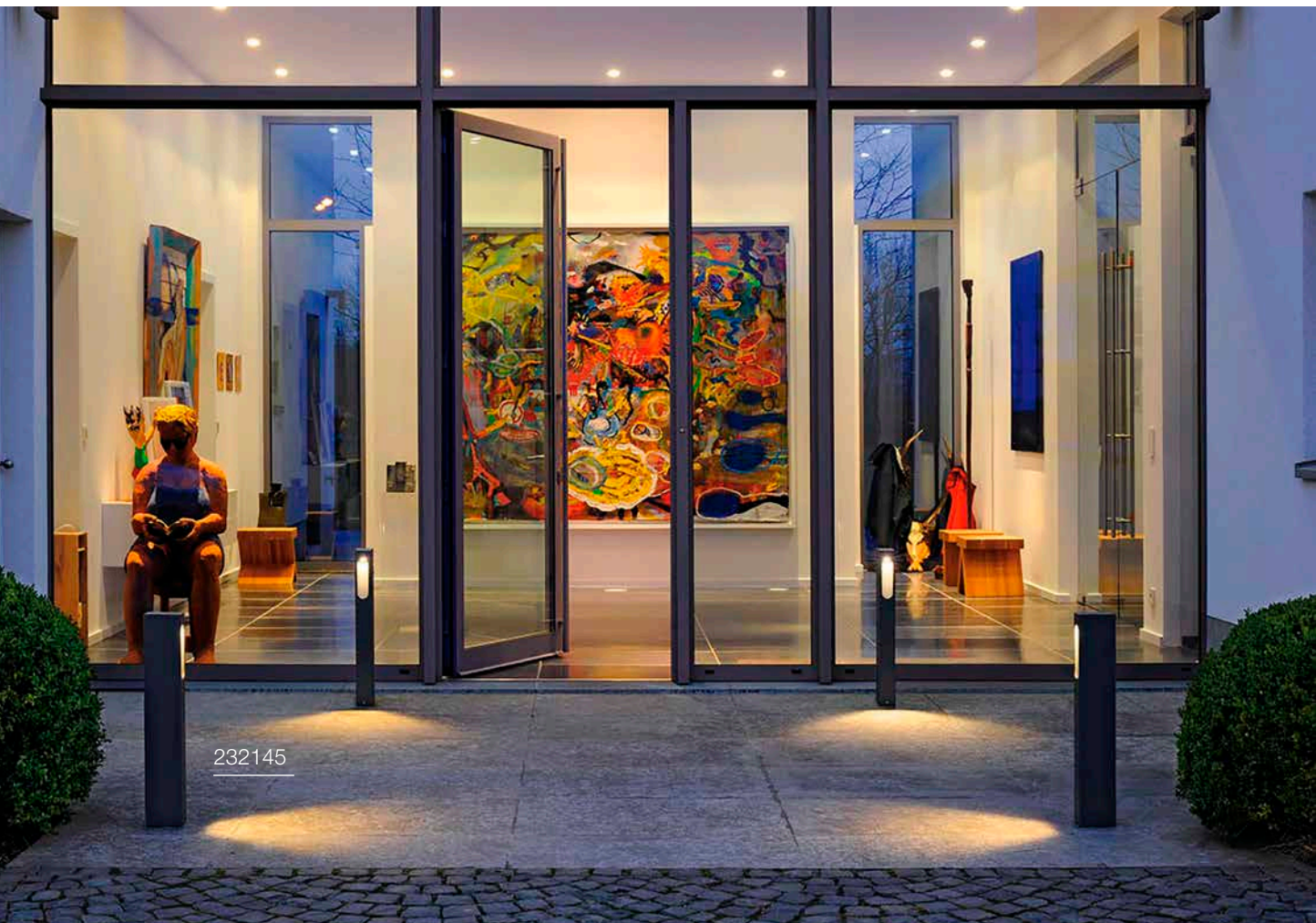

232145

SLOTBOX 40 Pole

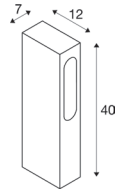

100-277 V ~50/60 Hz | 700 mA
Total wattage: 8 W
Material: Aluminium

- open cable end



160lm|3000 K

Options	Prod. no.
● anthracite	232135



Product	Prod. no.
Connection box IP68, 3-pole	
● black	228730

SLOTBOX 70 Pole

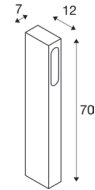

100-277 V ~50/60 Hz | 700 mA
Total wattage: 8.7 W
Material: Aluminium

- open cable end



160lm|3000 K

Options	Prod. no.
● anthracite	232145



Product	Prod. no.
Connection box IP68, 3-pole	
● black	228730



1008727

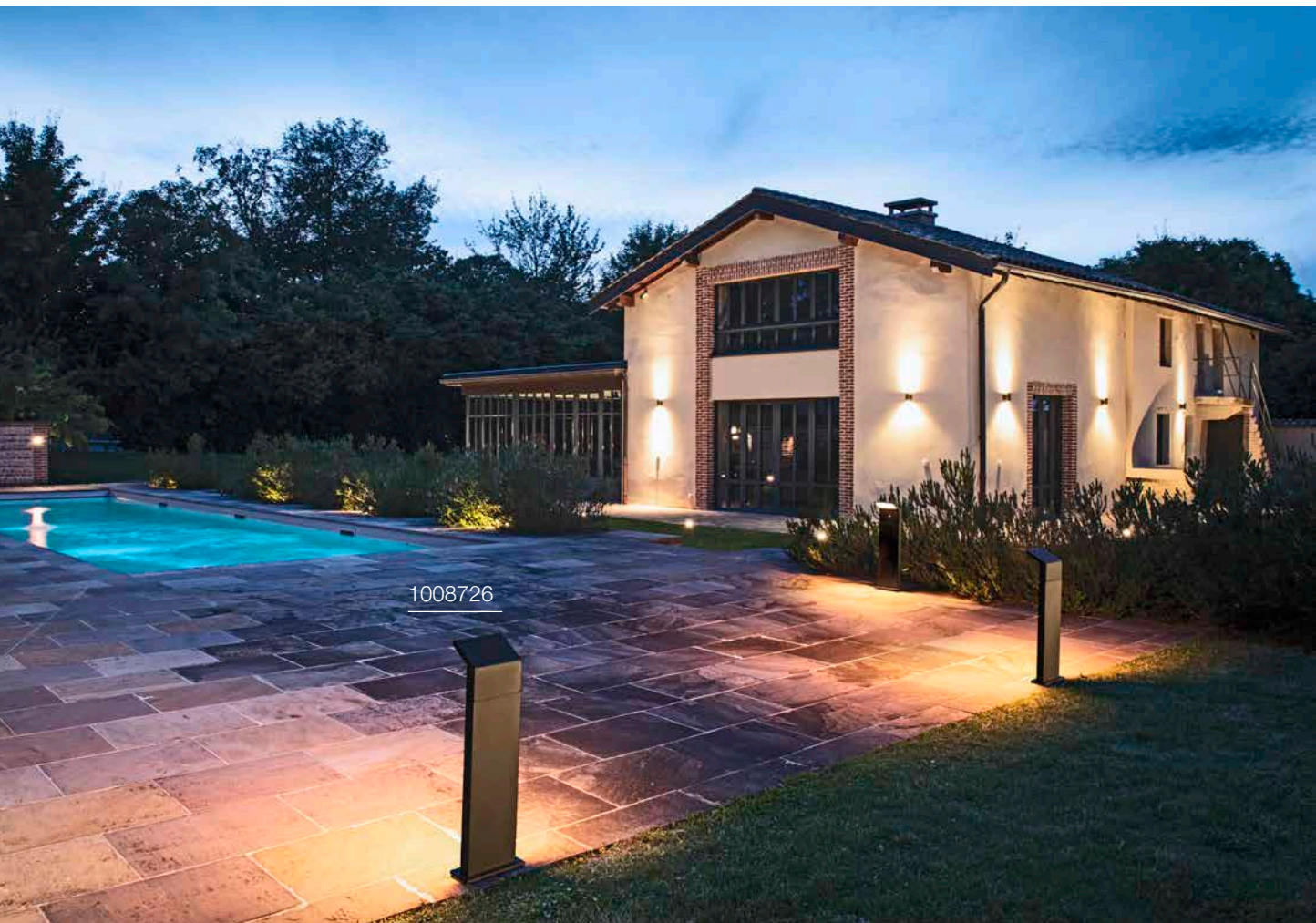

1008726



ORDI II 45 Pole, PHASE

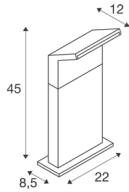

220-240 V ~50/60 Hz | 240 mA
Total wattage: 9.5 W
Material: Aluminium

- The light colour must be set prior to installation
- IP connection box



700 lm | 2200 K | 850 lm | 3000 K

Options	Prod. no.
● black	1008725

ORDI II 70 Pole, PHASE

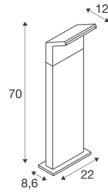

220-240 V ~50/60 Hz | 240 mA
Total wattage: 9.5 W
Material: Aluminium

- The light colour must be set prior to installation
- IP connection box



700 lm | 2200 K | 850 lm | 3000 K

Options	Prod. no.
● black	1008726

ORDI II 70 Pole, Sensor

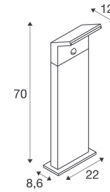

100-240 V ~50/60 Hz | 240 mA
Total wattage: 9.5 W
Material: Aluminium

- The light colour must be set prior to installation
- Primary and replica functionality
- IP connection box



700 lm | 2200 K | 850 lm | 3000 K

Options	Prod. no.
● black	1008727

ABRIDOR HYBRID 60 Pole

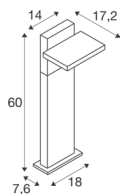

100-240 V ~50/60 Hz | 380 mA
 Total wattage: 6.8 W
 Material: Aluminium

- Solar and 230V operation possible
- 3 different modes
- Battery charging via solar
- IP68 connection box



600lm|2200K | 650lm|2700K

Options

Prod. no.

- anthracite

1008543

ABRIDOR HYBRID 100 Pole

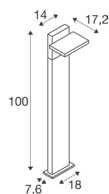

100-240 V ~50/60 Hz | 380 mA
 Total wattage: 6.8 W
 Material: Aluminium

- Solar and 230V operation possible
- 3 different modes
- Battery charging via solar
- IP68 connection box



600lm|2200K | 650lm|2700K

Options

Prod. no.

- anthracite

1008544



1002991



1008543



ABRIDOR 60 Pole

ABRIDOR 100 Pole

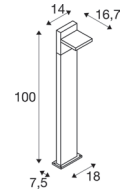
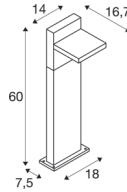

100-240 V ~50/60 Hz | 300 mA
Total wattage: 12 W
Material: Aluminium

100-240 V ~50/60 Hz | 300 mA
Total wattage: 12 W
Material: Aluminium

- open cable end

- The light colour must be set prior to installation
- open cable end



950 lm | 3000 K | 980 lm | 4000 K



950 lm | 3000 K | 980 lm | 4000 K

Options	Prod. no.
● anthracite	1002991

Options	Prod. no.
● anthracite	1002992



IPERI 50 Pole

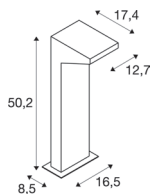

220-240 V ~50/60 Hz
Total wattage: 4.5 W
Material: Aluminium/Plastic

- open cable end



400lm | 4000 K

Options	Prod. no.
● anthracite	231305



Product	Prod. no.
Ground spike	
● grey	231231

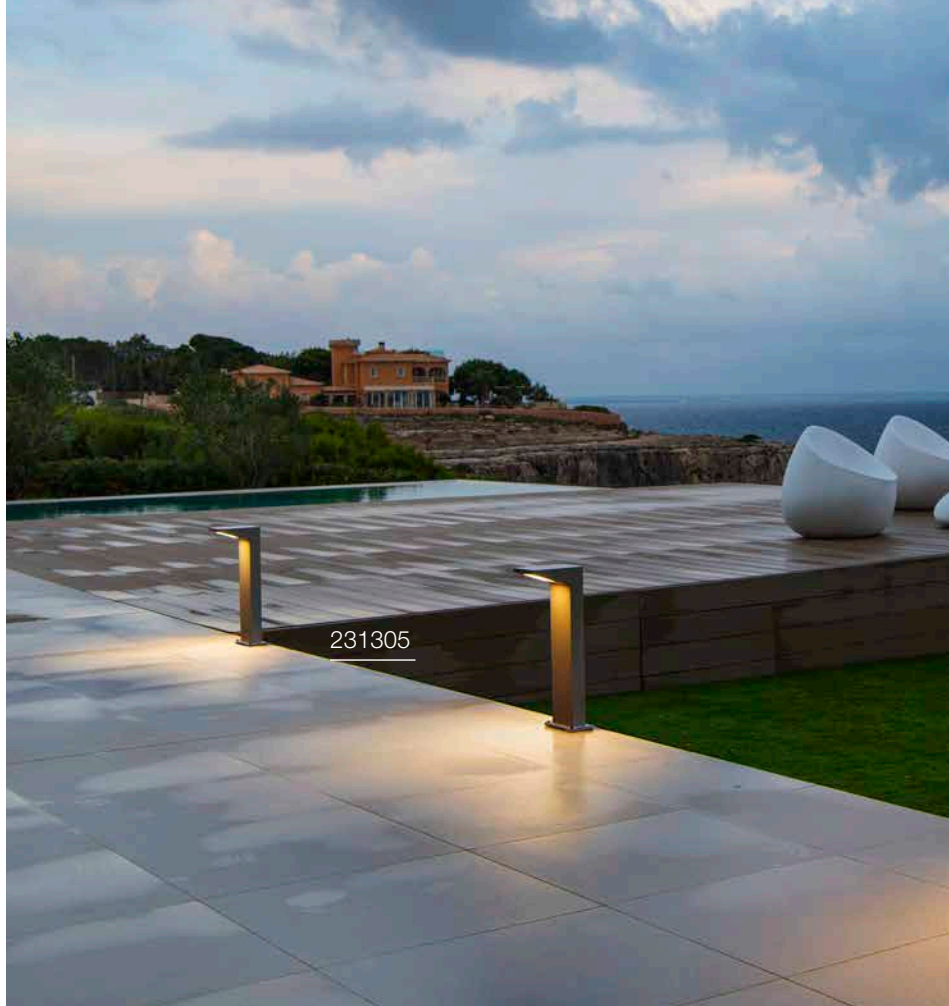



QUADRASYL 75

Pole, TCR-TSE

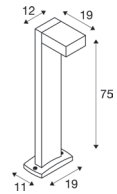

220-240 V ~50/60 Hz
Material: Aluminium

- Concrete anchor included
- open cable end



Base: 1xG53 max. Ø: 7.5 cm L: 2.7 cm

Options	Prod. no.
● anthracite	232295
● grey	232294



GX53 | 6 W | 120°
490 lm | 2700 K | EEC = G
7 kW/1000h



Prod. no.: 1005272



Product	Prod. no.
T-connector box	
● black	228726



QUAD Pole

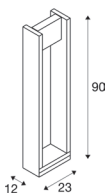

100-277 V ~50/60 Hz | 500 mA

Total wattage: 18 W

Material: Aluminium/Glass

- open cable end



1550lm|3000K

Options	Prod. no.
● anthracite	1003001



Product	Prod. no.
Connection box IP68, 3-pole	
● black	228730

BOOKAT Pole

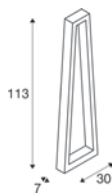

100-277 V ~50/60 Hz | 700 mA

Total wattage: 15 W

Material: Aluminium/Polycarbonate (PC)

- IP connection box included
- The light colour must be set prior to installation
- IP connection box



1240lm|3000K | 1300lm|4000K

Options	Prod. no.
● anthracite	1005441

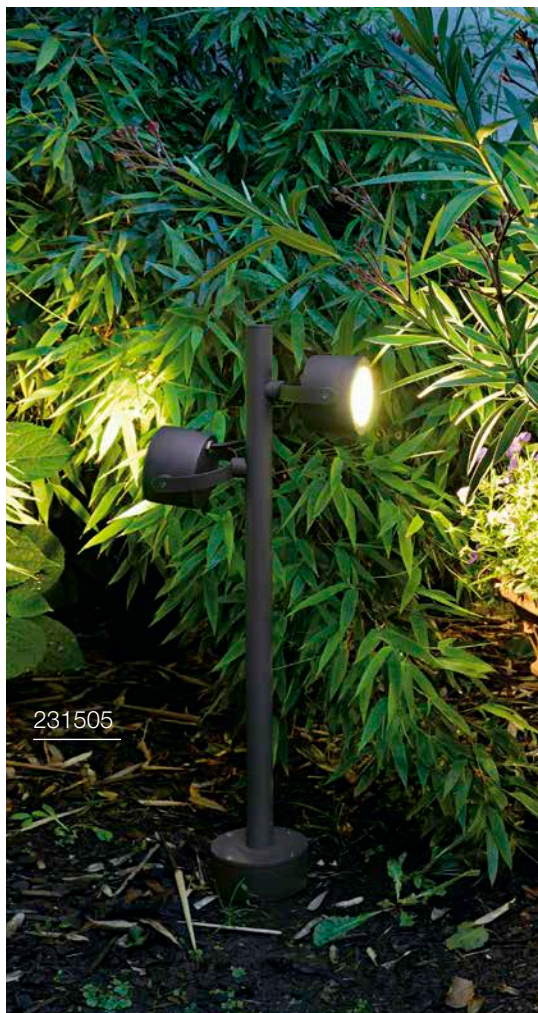



MYRA SPOT

Double, GU10

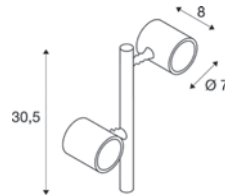

220-240 V ~50/60 Hz
Material: Aluminium

- The height of the light can be increased by a maximum of 2 extension rods.
- open cable end

SITRA 360

Pole, TCR-TSE

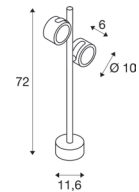

220-240 V ~50/60 Hz
Material: Aluminium/Glass



Base: 2xGU10 max. Ø: 5.1 cm | L: 5.7 cm

Options	Prod. no.
● anthracite	233185



GU10 | 6 W | 38°
450 lm | 2700 K | EEC = F
6 kW/1000h



Prod. no.: 1005077



Base: 2xG53 max. Ø: 7.5 cm | L: 3.5 cm

Options	Prod. no.
● anthracite	231505



GX53 | 6 W | 120°
490 lm | 2700 K | EEC = G
7 kW/1000h



Prod. no.: 1005272



Product	Prod. no.
Concrete anchor	
○ silver	228712
Screw set	
● Stainless steel	228752
Pedestal	
● anthracite	233145
Extension rod 30 cm	
● anthracite	233165



Product	Prod. no.
Ground spike	
● grey	230060
Ground spike	
● Stainless steel	1000736



1002871

THEO PATHLIGHT 73

Pole, double

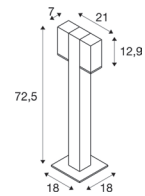

220-240 V ~50/60 Hz
Material: Aluminium

- open cable end



Base: 2xGU10

Options	Prod. no.
● anthracite	1002871



Product	Prod. no.
Connection box IP68, 3-pole	
● black	228730



1007869



LED
SYNA WIDE | 120



LED
SYNA SHADE | 121



LED
SYNA PLANT | 123



LED
SYNA GARDEN | 123



LED
SYNA | 123



LED
GALEN 60 | 124



LED
GALEN 120 | 124



LED
GALEN PRO | 125



LED
HELIA SPOT | 126-127



LED
FLAC BEAM | 127



SECKET
SAMRINA | 127



SECKET
NAUTILUS 10 | 128-129



SECKET
BIG NAUTILUS | 129



LED
NAUTILUS 10 | 130



SECKET
NAUTILUS | 133



LED
SECKET
NAUTILUS 10 SPOT | 133



LED
DASAR® PROJECTOR
| 133



LED
DASAR® 920 | 133



LED
HELIA SLIM | 135



SECKET
THEO BRACKET | 137



LED
LED SPIKE | 137



SECKET
SITRA 360 SPIKE | 139



SECKET

SYNA WIDE SP

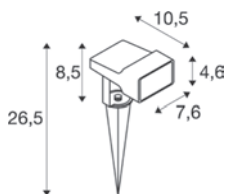

220-240 V ~50/60 Hz | 500 mA
 Total wattage: 5.5 W
 Material: aluminium

- IP44 safety plug



500 lm | 2200 K | 650 lm | 3000 K

Options	Prod. no.
● black 500 lm 2200 K	1008478
● black 650 lm 3000 K	1008479





SYNA SHADE SP, GU10

NEW

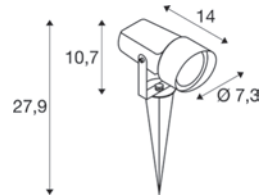

220-240 V ~50/60 Hz
Material: aluminium

- IP44 safety plug

1008480



1008479



Base: 1xGU10 max. Ø: 5 cm | L: 5.3 cm

Options	Prod. no.
● black	1008480 ●



GU10 | 2W | 36°
230lm | 2700K | EEC = E
3kW/1000h



Prod. no.: 1007230



227505

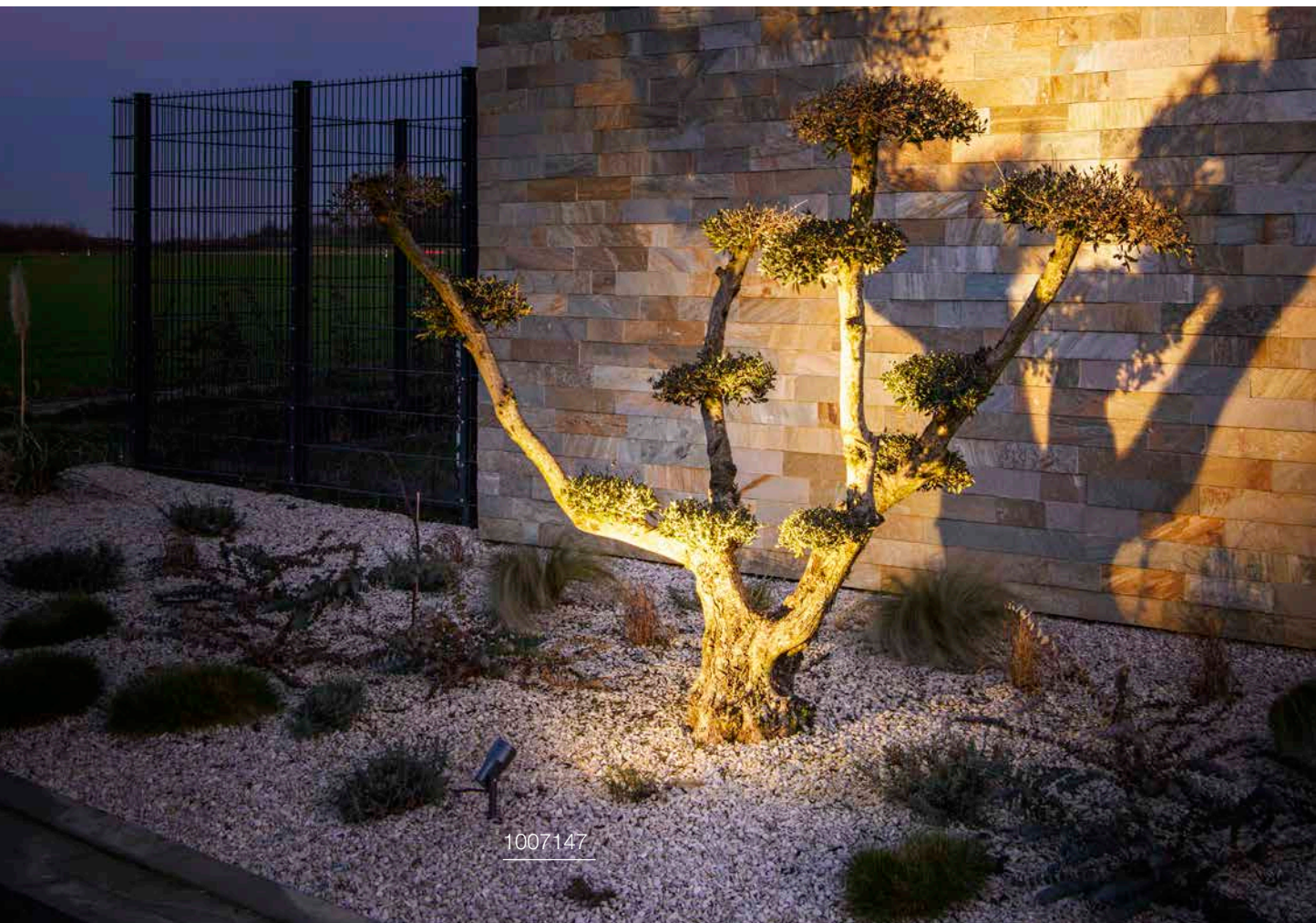

1007147



SYNA PLANT SP

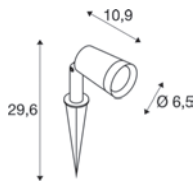

220-240 V ~50/60 Hz | 250 mA
Total wattage: 6 W
Material: aluminium

- IP44 safety plug



540lm|3000K

Options

- black

Prod. no.

1007146

SYNA GARDEN SP

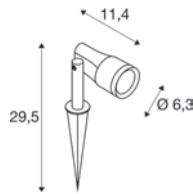

220-240 V ~50/60 Hz | 250 mA
Total wattage: 6 W
Material: aluminium

- IP44 safety plug



540lm|3000K

Options

- black

Prod. no.

1007147

SYNA SP

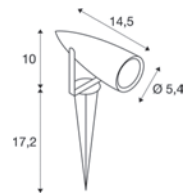

220-240 V ~50/60 Hz
Total wattage: 9 W
Material: aluminium

- IP44 safety plug



470lm|3000K

Options

- anthracite

Prod. no.

227505

GALEN 60 SP

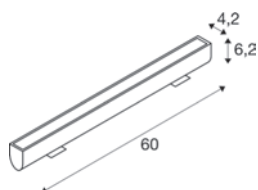

220-240 V ~50/60 Hz | 450 mA
Total wattage: 18 W
Material: aluminium



1570 lm | 3000 K | 1570 lm | 4000 K

Options	Prod. no.
● anthracite	1003447



Product	Prod. no.
5 m connection cable with open cable end	
● black	231960
Connection cable 1.0m	
● black	231961

GALEN 120 SP

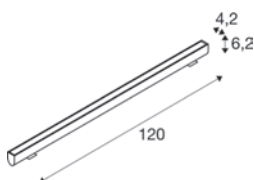

220-240 V ~50/60 Hz | 900 mA
Total wattage: 34 W
Material: aluminium

- IP67 plug-in system



3000 lm | 3000 K | 3100 lm | 4000 K

Options	Prod. no.
● anthracite	1003448



Product	Prod. no.
5 m connection cable with open cable end	
● black	231960
Connection cable 1.0m	
● black	231961





GALEN Pro 60 WL, DALI

GALEN Pro 120 WL, DALI

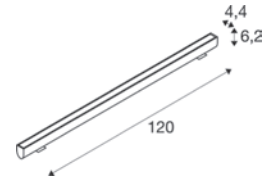
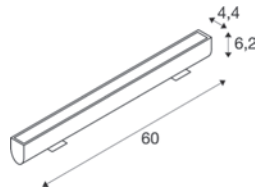

220-240 V ~0/50/60 Hz | 305 mA
Total wattage: 20 W
Material: aluminium/glass

220-240 V ~0/50/60 Hz | 335 mA
Total wattage: 40 W
Material: aluminium/glass

- Asym. light distribution for optimum illumination of paths
- IP connection box

- Asym. light distribution for optimum illumination of paths
- IP connection box



Asymetrical 2300lm|3000 K



Asymetrical 5150lm|3000 K

Options	Prod. no.
● anthracite	1009107 ●

Options	Prod. no.
● anthracite	1009108 ●



Product	Prod. no.
Wall bracket	
● grey	234354



Product	Prod. no.
Wall bracket	
● grey	234354

1003448



231072

HELIA SPOT S

SP, single

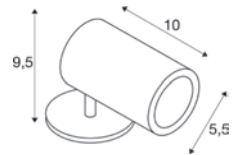

220-240 V ~50/60 Hz | 500 mA

Total wattage: 6.5 W

Material: aluminium

- IP44 safety plug



228555



440 lm | 3000 K

Options	Prod. no.
● anthracite	1000735



Product	Prod. no.
Ground spike	
● stainless steel	1000736



HELIA SPOT L

SP, single, PHASE

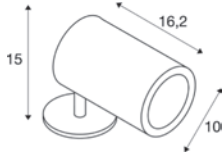

220-240 V ~50/60 Hz | 700 mA
 Total wattage: 15 W
 Material: aluminium

- IP44 safety plug



1340lm|3000K

Options	Prod. no.
● anthracite	228555



Product	Prod. no.
Ground spike	
● stainless steel	228560

FLAC BEAM

SP

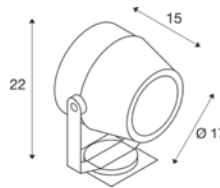

220-240 V ~50/60 Hz
 Total wattage: 27 W
 Material: aluminium

- IP44 safety plug



1600lm|3000K

Options	Prod. no.
● grey	231072

SAMRINA

SP, single, GU10

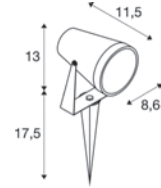

220-240 V ~50/60 Hz
 Material: plastic

- Contains recycled material
- IP44 safety plug



Base: GU10 max. Ø: 6 cm | L: 6 cm

Options	Prod. no.
● black	1004757



GU10 | 6 W | 38°
 450 lm | 2700 K | EEC = F
 6 kW/1000 h



Prod. no.: 1005077

NAUTILUS 10

SP, round, QPAR51

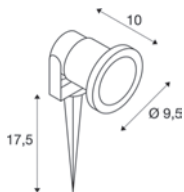

220-240 V ~50/60 Hz
Material: aluminium

- IP44 safety plug



Base: 1xGU10

L: 5.7 cm

Options

Prod. no.

- grey

227418



GU10 | 6W | 38°
450lm | 2700K | EEC = F
6 kW/1000h



Prod. no.: 1005077

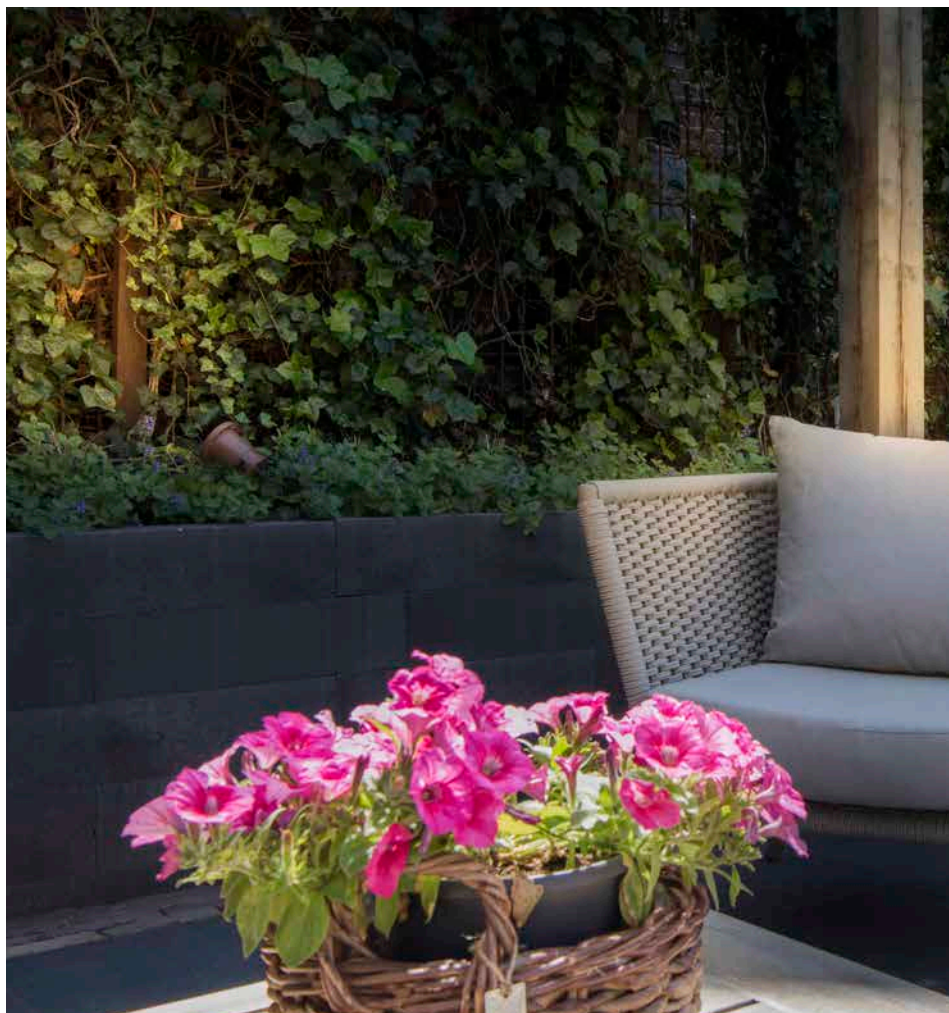



BIG NAUTILUS

SP, round, QPAR51

NAUTILUS 10

SP, round, QPAR51

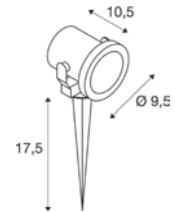
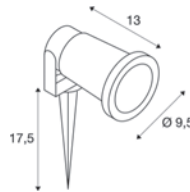

220-240 V ~50/60 Hz
Material: aluminium

220-240 V ~50/60 Hz
Material: stainless steel 316

- Earth spike made from recycled plastic
- IP44 safety plug

- IP44 safety plug



Base: GU10 max. Ø: 5.1 cm | L: 8.3 cm

Base: 1xGU10 max. Ø: 5.1 cm | L: 5.7 cm

Options	Prod. no.
● black	227410
● rust	1001964
● green	1001965

Options	Prod. no.
● stainless steel	229740



GU10 | 6 W | 38°
450 lm | 2700 K | EEC = F
6 kW/1000 h



Prod. no.: 1005077



GU10 | 6 W | 38°
450 lm | 2700 K | EEC = F
6 kW/1000 h



Prod. no.: 1005077

1001964



231035

NAUTILUS 10

SP, square

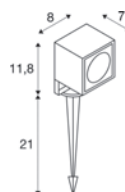

100-277 V ~50/60 Hz | 700 mA

Total wattage: 8.5 W

Material: aluminium/glass

- IP44 safety plug



660lm|3000K

Options	Prod. no.
● anthracite	231035



1001962



NAUTILUS SP, QR-C51

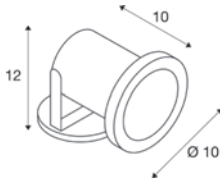

12 V 50/60 Hz
Material: stainless steel 304/glass

- open cable end



Base: 1xGX5.3

Options	Prod. no.
● stainless steel	229090



GU5.3 | 6 W | 36°
450 lm | 2700 K | EEC = G
6 kW/1000 h

Prod. no.: **1001574**



NAUTILUS 10 SPOT SP, QPAR51

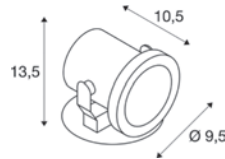

220-240 V ~50/60 Hz
Material: stainless steel 316

- open cable end



Base: 1xGU10 max. Ø: 5.1 cm | L: 6 cm

Options	Prod. no.
● stainless steel	229741



GU10 | 6 W | 38°
450 lm | 2700 K | EEC = F
6 kW/1000 h

Prod. no.: **1005077**



Product	Prod. no.
Connection box IP68, 3-pole	
● black	228730

NAUTILUS 10 SPOT SP, LED

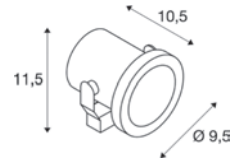

220-240 V ~50/60 Hz
Total wattage: 9 W
Material: stainless steel 316

- IP44 safety plug



520 lm | 3000 K

Options	Prod. no.
● stainless steel	1001962



Product	Prod. no.
Plastic ground spike	
● black	900011
Mounting plate	
● stainless steel	1001963



233570





DASAR® PROJECTOR SP, 12/24V

DASAR® 920 SP, 230V

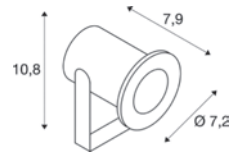
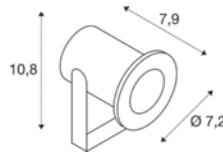

12-24 V
Total wattage: 6.5 W
Material: stainless steel 316/glass

220-240 V ~50/60 Hz | 400 mA
Total wattage: 4.6 W
Material: stainless steel 316/glass

- open cable end

- IP44 safety plug



520lm|3000 K

300lm|3000 K

Options	Prod. no.
● stainless steel	233570

Options	Prod. no.
● stainless steel	233571



Product	Prod. no.
Stainless steel 316 ground spike	
● stainless steel	233580
Stainless steel 316 mounting plate	
● stainless steel	233582
Plastic ground spike	
● black	900011
LED power supply, 15W 12V	
○ white	1005444
LED power supply, 15 W 24V	
○ white	1005445

Product	Prod. no.
Stainless steel 316 ground spike	
● stainless steel	233580
Stainless steel 316 mounting plate	
● stainless steel	233582
Plastic ground spike	
● black	900011



1007868

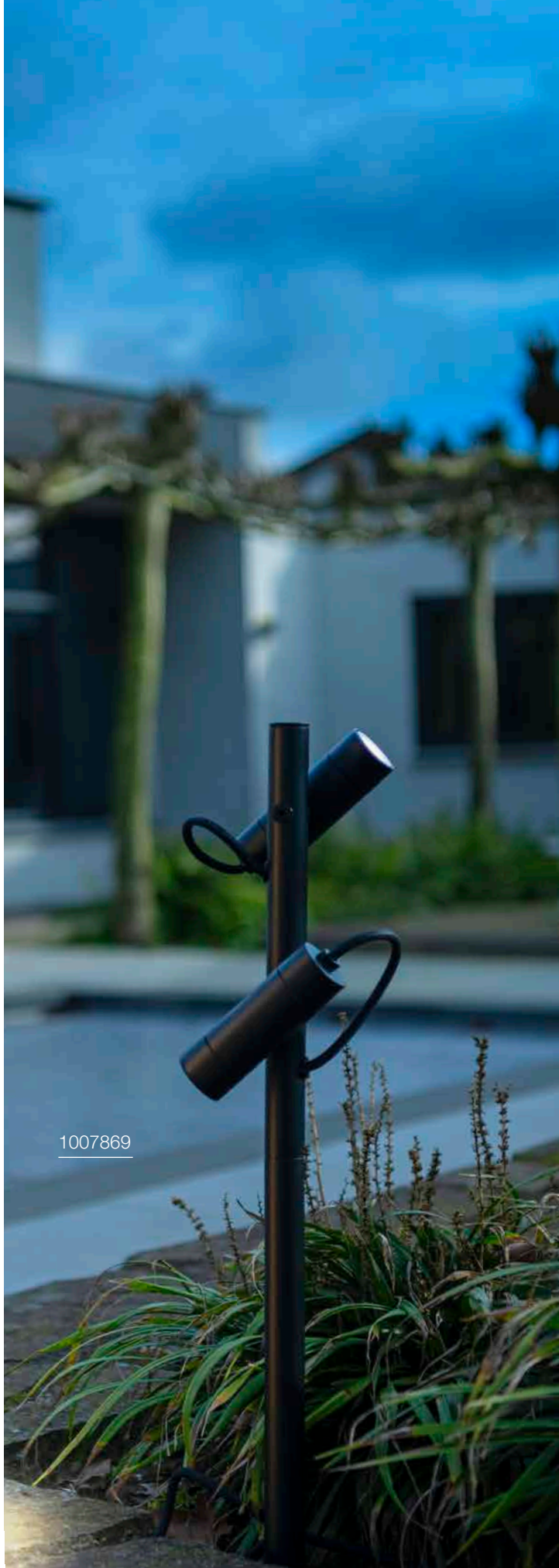

1007869



HELIA SLIM

Pole, single

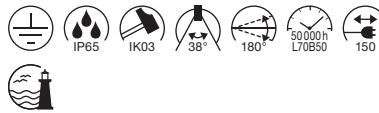
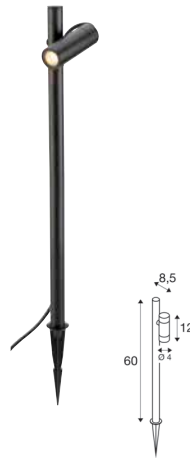

220-240 V ~50/60 Hz | 500 mA
 Total wattage: 6 W
 Material: aluminium

- IP44 safety plug



450lm|3000 K

Options	Prod. no.
● black	1007868

HELIA SLIM

Pole, double



220-240 V ~50/60 Hz | 500 mA
 Total wattage: 12 W
 Material: aluminium

- IP44 safety plug



Down

450lm|3000 K

Options	Prod. no.
● black	1007869



1004652

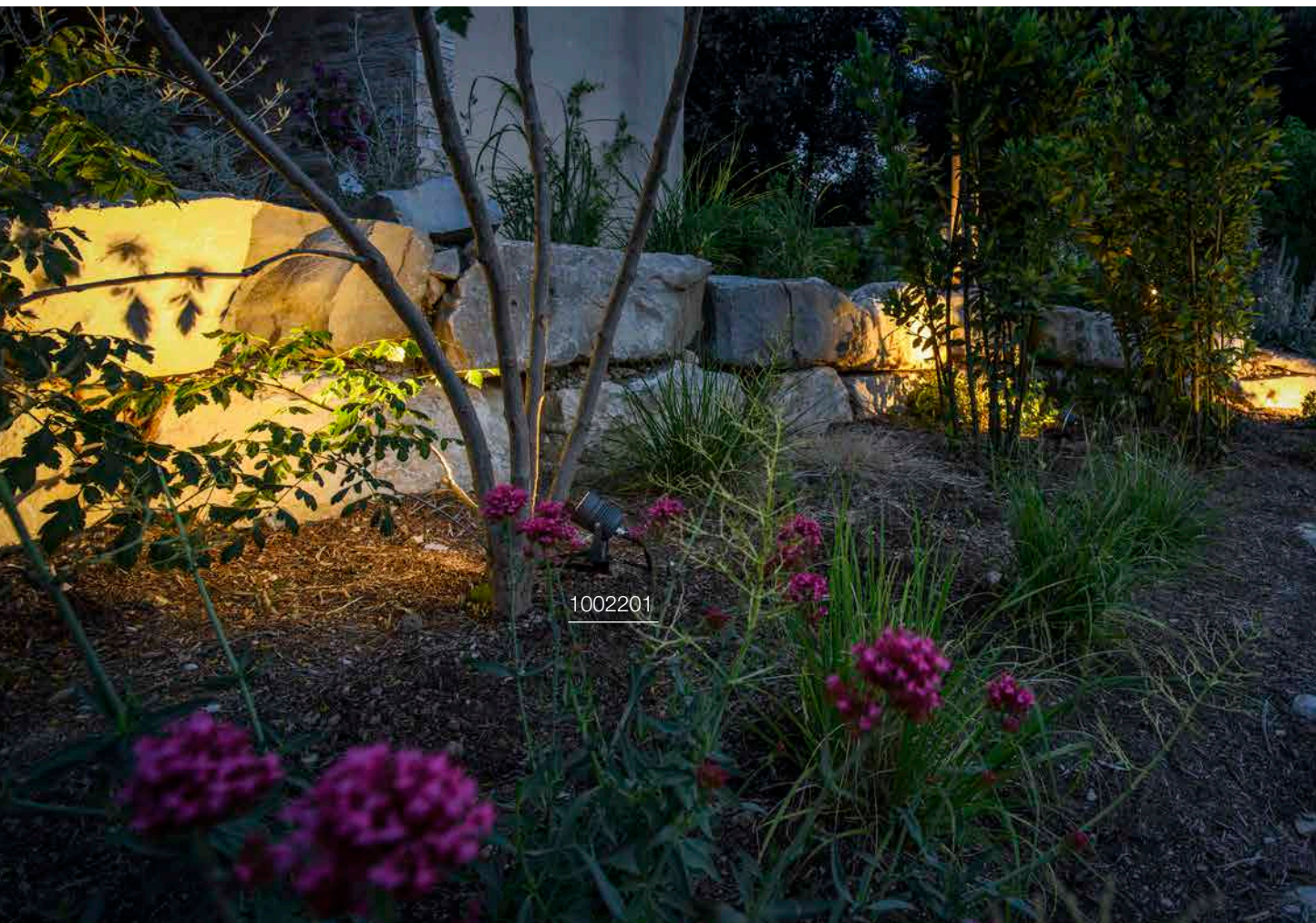

1002201



THEO BRACKET SP

LED SPIKE SP

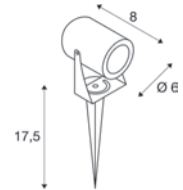
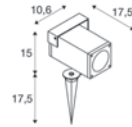

220-240 V ~50/60 Hz
Material: aluminium/glass

100-240 V ~50/60 Hz | 240 mA
Total wattage: 6 W
Material: aluminium/glass

- IP44 safety plug

- IP44 safety plug



Base: 1xGU10 max. Ø: 5.1 cm | L: 5.7 cm

400lm|3000 K

Options	Prod. no.
● anthracite	1004652

Options	Prod. no.
● anthracite	1002201
● rust	1002203



GU10 | 6 W | 38°
450 lm | 2700 K | EEC = F
6 kW/1000 h



Prod. no.: 1005077





231535



SITRA 360 SPIKE SP, single, TCR-TSE

SITRA 360 SPIKE SP, double, TCR-TSE

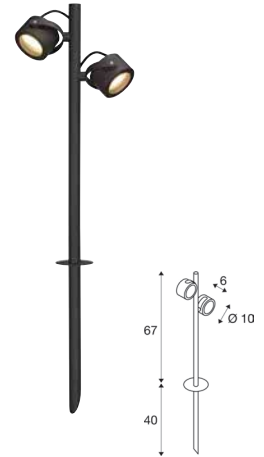
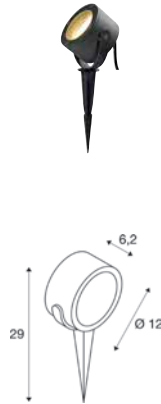

220-240 V ~50/60 Hz
Material: aluminium/glass

220-240 V ~50/60 Hz
Material: aluminium/glass

- Earth spike made from recycled plastic
- IP44 safety plug

- IP44 safety plug



Base: 1xG53 max. Ø: 7.5 cm | L: 3.5 cm

Base: 2xG53 max. Ø: 7.5 cm | L: 3.5 cm

Options	Prod. no.
● anthracite	231525

Options	Prod. no.
● anthracite	231535

GX53 | 6W | 120°
490 lm | 2700 K | EEC = G
7 kW/1000 h



Prod. no.: 1005272

GX53 | 6W | 120°
490 lm | 3000 K | EEC = G
7 kW/1000 h



Prod. no.: 1005271

1006327





SECKET

PHOTONI | 143



SECKET

BIG THEO | 149



LED

CUBE | 144



LED

ESKINA FRAME | 145



ENOLA® OCULUS | 146



ENOLA® ROUND | 147



LED

ENOLA® SQUARE | 148



SECKET

BIG THEO | 149



LED

OVALISK | 150



SECKET

MOLAT | 151



SITRA | 152



ROX | 153



1007586

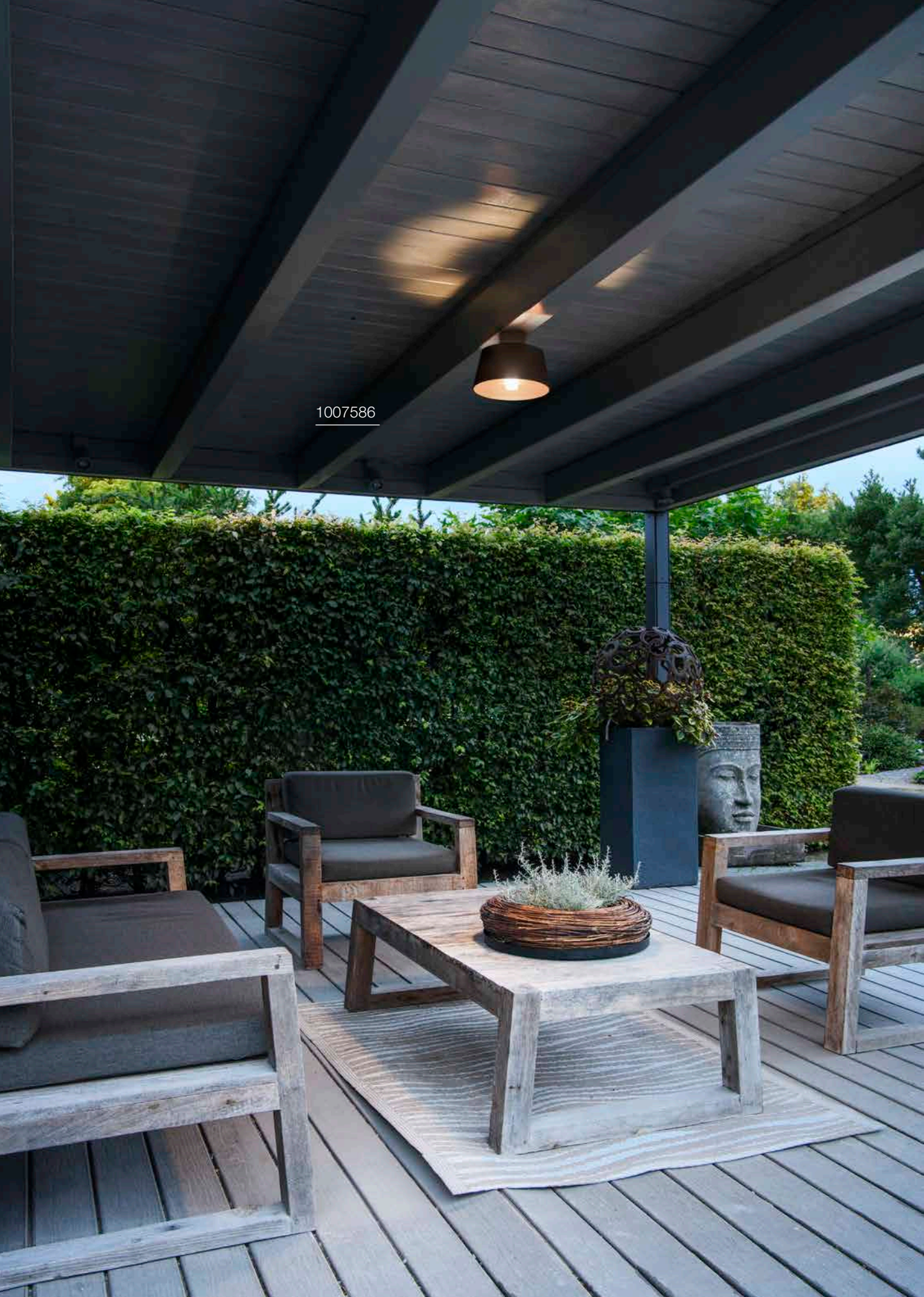



PHOTONI CYL CL, E27

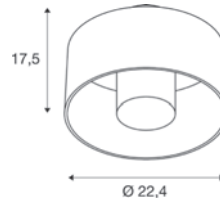

220-240 V ~50/60 Hz
Material: aluminium



Base: 1xE27 max. Ø: 6 cm | L: 11.6 cm

Options	Prod. no.
● black	1008199
● rust	1008200



E27 | 4 W | 280°
830 lm | 2700 K | EEC = A
4 kW/1000h

Prod. no.: 1008641

PHOTONI CL, E27

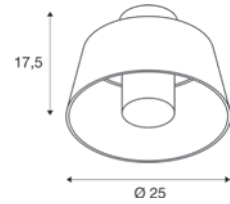

220-240 V ~50/60 Hz
Material: aluminium

- Sea-air resistant



Base: 1xE27 max. Ø: 6 cm | L: 11.6 cm

Options	Prod. no.
● black	1007586
● rust	1007582



E27 | 8 W | 240°
880 lm | 3000 K | EEC = E
8 kW/1000h

Prod. no.: 1005289



CUBE CL, PHASE

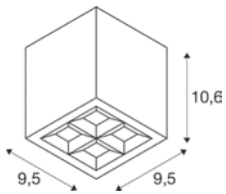

220-240 V ~50/60 Hz | 350 mA
Total wattage: 15 W
Material: aluminium

- The light colour must be set prior to installation



1000 lm | 2700 K | 1200 lm | 3000 K

Options

Prod. no.

- anthracite

1007461

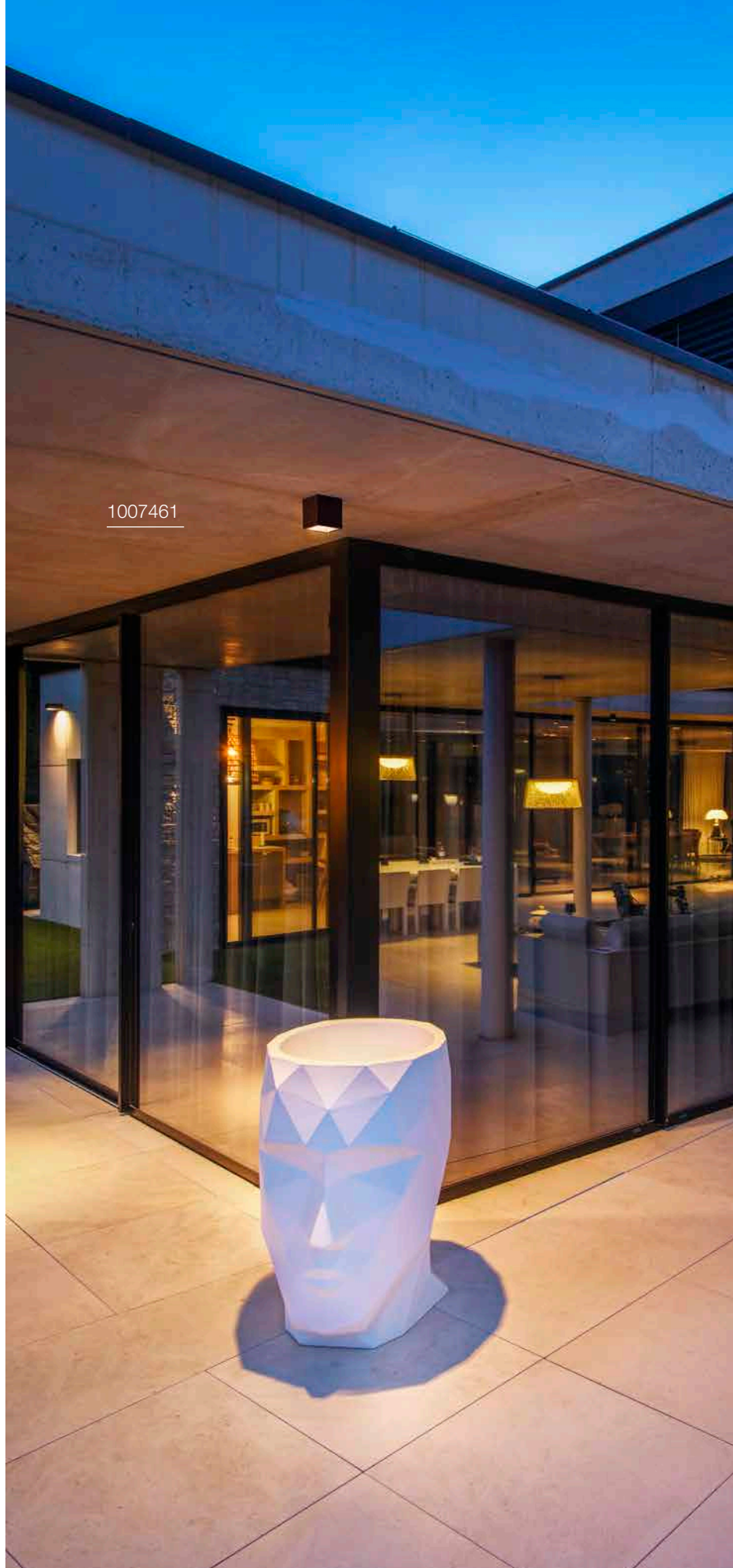

1007461



ESKINA FRAME

CL, single, PHASE

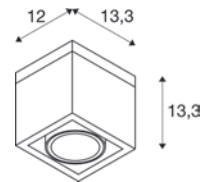

220-240 V ~50/60 Hz | 350 mA

Total wattage: 15 W

Material: aluminium/glass

- The light colour must be set prior to installation
- Light head is pivoting



Direct 1100 lm | 3000 K | 1200 lm | 4000 K

Options	Prod. no.
● anthracite	1006316

1006316

ENOLA® OCULUS CL

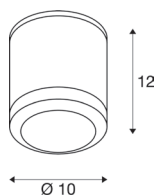

220-240 V ~50/60 Hz | 500 mA

Total wattage: 11 W

Material: aluminium/glass

- The light colour must be set prior to installation



1000lm|3000K | 1100lm|4000K

Options	Prod. no.
---------	-----------

- | | |
|--------------|---------|
| ● anthracite | 1006327 |
|--------------|---------|



Product	Prod. no.
---------	-----------

Spacer

- | | |
|--------------|---------|
| ● anthracite | 1003479 |
|--------------|---------|

1003427





ENOLA® ROUND S CL

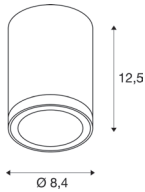

220-240 V ~50/60 Hz | 500 mA
Total wattage: 9 W
Material: aluminium/glass

- The light colour must be set prior to installation



540 lm | 3000 K | 610 lm | 4000 K

Options	Prod. no.
● anthracite	1003426



Product	Prod. no.
Spacer	
● anthracite	1003479

ENOLA® ROUND M CL

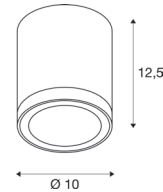

220-240 V ~50/60 Hz | 500 mA
Total wattage: 11 W
Material: aluminium/glass

- The light colour must be set prior to installation
- Conveniently adjustable light distribution using interchangeable 19°, 60° and asymmetric optics as accessories



840 lm | 3000 K | 960 lm | 4000 K

Options	Prod. no.
● anthracite	1003427



Product	Prod. no.
Spacer	
● anthracite	1003479
● lens 19°	
● black	1005205
Asymmetrical lens	
● black/chrome	1005206
Reflector 60°	
● chrome	1005207

ENOLA® ROUND L CL

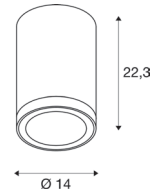

220-240 V ~50/60 Hz | 900 mA
Total wattage: 36 W
Material: aluminium/glass

- The light colour must be set prior to installation
- Conveniently adjustable light distribution using 60° interchangeable optics as an accessory



3200 lm | 3000 K | 3500 lm | 4000 K

Options	Prod. no.
● anthracite	1003442



Product	Prod. no.
Spacer	
● anthracite	1003479
Reflector 60°	
● chrome	1005263

ENOLA® SQUARE S CL

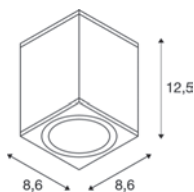

220-240 V ~50/60 Hz | 500 mA
Total wattage: 9 W
Material: aluminium/glass

- The light colour must be set prior to installation



540 lm | 3000 K | 610 lm | 4000 K

Options	Prod. no.
● anthracite	1003420



Product	Prod. no.
Spacer	
● anthracite	1003479

ENOLA® SQUARE M CL

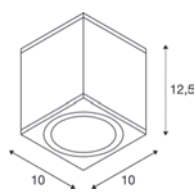

220-240 V ~50/60 Hz | 500 mA
Total wattage: 11 W
Material: aluminium/glass

- The light colour must be set prior to installation
- Conveniently adjustable light distribution using interchangeable 19°, 60° and asymmetric optics as accessories



840 lm | 3000 K | 960 lm | 4000 K

Options	Prod. no.
● anthracite	1003421



Product	Prod. no.
Spacer	
● anthracite	1003479
Lens 19°	
● black	1005205
Asymmetrical lens	
● black/chrome	1005206
Reflector 60°	
● chrome	1005207

1003421





BIG THEO
CL

BIG THEO
CL, QPAR111

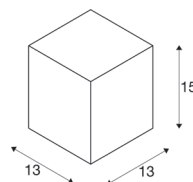
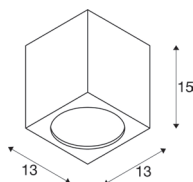
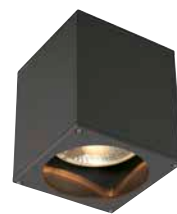

100-277 V ~50/60 Hz | 500 mA
Total wattage: 21 W
Material: aluminium/glass



220-240 V ~50/60 Hz
Material: aluminium/glass

234535



2000lm|3000 K



Base: 1xGU10

Options	Prod. no.
● anthracite	234535

Options	Prod. no.
● anthracite	229555
○ white	229551
● grey	229554



GU10 | 13 W | 12°
650 lm | 3000 K | EEC = F
13 kW/1000h



Prod. no.: 1005278

OVALISK CL

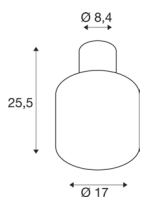

220-240 V ~50/60 Hz | 350 mA

Total wattage: 7.9 W

Material: aluminium/glass

- The light colour must be set prior to installation



540 lm | 3000 K | 570 lm | 4000 K

Options

- anthracite

Prod. no.

1004677

1004677



**MOLAT**
CL, E27

1000823

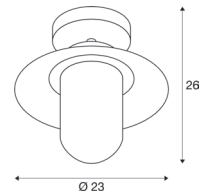
220-240 V ~50/60 Hz
Material: aluminium/glass

Base: 1xE27 max. Ø: 6.5 cm L: 14.5 cm

Options	Prod. no.
● anthracite	1000823

E27 | 8 W | 320°
700 lm | 2500 K | EEC = F
8 kW/1000h**Prod. no.:** 1005265



231545

SITRA CL, TCR-TSE

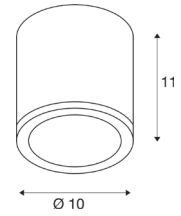

220-240 V ~50/60 Hz
Material: aluminium/glass



Base: 1xG53 max. Ø: 7.5 cm | L: 3.5 cm

Options	Prod. no.
● anthracite	231545
○ white	231541



GX53 | 6 W | 120°
490 lm | 2700 K | EEC = G
7 kW/1000h



Prod. no.: 1005272



1000339

ROX
CL, QPAR111

ROX
CL, GX53

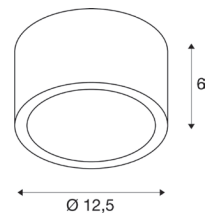
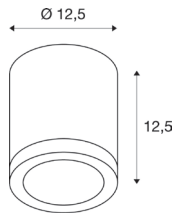

220-240 V ~50/60 Hz
Material: aluminium/glass



220-240 V ~50/60 Hz
Material: aluminium/glass



Base: 1xGU10



Base: 1xGX53 max. Ø: 7.5 cm L: 3.5 cm

Options	Prod. no.
● aluminium	1000332

Options	Prod. no.
● aluminium	1000339



GU10 | 13 W | 12°
650 lm | 3000 K | EEC = F
13 kW/1000h



Prod. no.: **1005278**



GX53 | 6 W | 120°
490 lm | 3000 K | EEC = G
7 kW/1000h



Prod. no.: **1005271**



1010107



LED
R-CUBE | 159



LED
S-CUBE | 159



SECKET
PHOTONI | 160



SECKET



LED
MODELA | 161



LED
LID I | 162



LED
LID I | 162



LED
LID II | 163

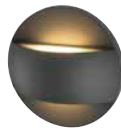

LED
Q-RING | 164



LED
I-RING | 165



LED
D-RING | 165-166



LED
OVAL | 167



LED
CONCRETO | 168



LED
RASTERLYS | 169



SECKET
T-TUBE | 170-171



SECKET
S-TUBE | 173



LED
FLATT II | 174-175

NEW



LED
FLATT | 176-177



SECKET
THEO | 169



LED
SECKET
BIG THEO | 169-181



LED
THEO PRO | 183-185

NEW



LED
HELIA PRO | 189-193

NEW



LED
SITRA | 195-197



SECKET
SITRA CUBE | 197



LED
BIG QUAD | 199



LED
QUAD | 200



LED
RUSTY® UP/DOWN |
201



LED
RUSTY® UP/DOWN |
201



LED
ENOLA® OCULUS | 203



LED
ENOLA® ROUND |
203-207



LED
ENOLA® SQUARE |
209-210



SECKET
GRAFT | 214-215





SECKET
SQUARE | 216



LED
SECKET
QUADRULO | 217-219



SECKET
MERIDIAN BOX | 220-221



SECKET
MERIDIAN | 220



LED
ESKINA FRAME | 223

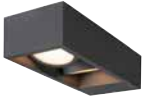

LED
ESKINA FRAME | 223



LED
BOOKAT | 224

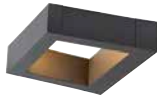

LED
TAHA II | 224



LED
OVALISK | 225



LED
PEMA® | 226

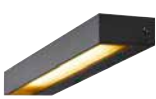

LED
SECKET
PEMA® | 227



SECKET
ASTINA | 228



SECKET
ASTINA STEEL | 228



LED
ANGOLUX | 229



LED
VILUA | 231



LED
VILUA | 231



SECKET
MYRA UP/DOWN | 232



SECKET
SITRA | 233



SECKET
ROX | 235



LED
DELWA | 235



SECKET
WALLYX | 236



LED
DOWNUNDER OUT | 237



LED
ABRIDOR | 239-241



ORDI II | 242



ORDI | 243



LED
SECKET
BOX-L | 245



SECKET
BOX | 245



LED
LOGS | 247



LED
OUT-BEAM UP/
FLOOD DOWN | 247



LED
L-LINE OUT | 247



SECKET
PHOTONIA | 249



SCKET
MOLAT | 249



SCKET
GLOO PURE | 249



SCKET
F-POL | 250



LED
IPERI | 250



SCKET
QUADRASYL | 251

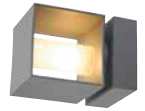

SCKET
SQUARE TURN | 251



LED
TODAY PRO | 252



LED
ESKINA D | 253



SCKET
MYRA DISPLAY | 253



SCKET
MYRA | 253



LED
LED SPOT | 255



SCKET
NAUTILUS | 255



SCKET
MYRA | 255



LED
ESKINA SPOT | 257



SCKET
SITRA 360 | 258



SCKET
THEO BRACKET | 258



LED
HELIA | 259



LED
AINOS | 260-261



LED
RUBA | 262



LED
TERANG 200 | 262



SCKET
BULAN | 263



SCKET
BULAN GRID | 263





1007511



1007458



R-CUBE WL, PHASE

S-CUBE CW, PHASE

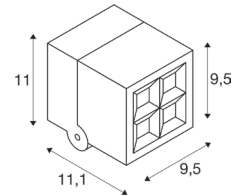
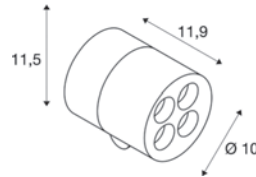

220-240 V ~50/60 Hz | 350 mA
Total wattage: 15 W
Material: aluminium

220-240 V ~50/60 Hz | 350 mA
Total wattage: 15 W
Material: aluminium

- The light colour must be set prior to installation

- The light colour must be set prior to installation



800lm|2700K | 800lm|3000K



1000lm|2700K | 1200lm|3000K

Options	Prod. no.
● anthracite	1007511

Options	Prod. no.
● anthracite	1007458

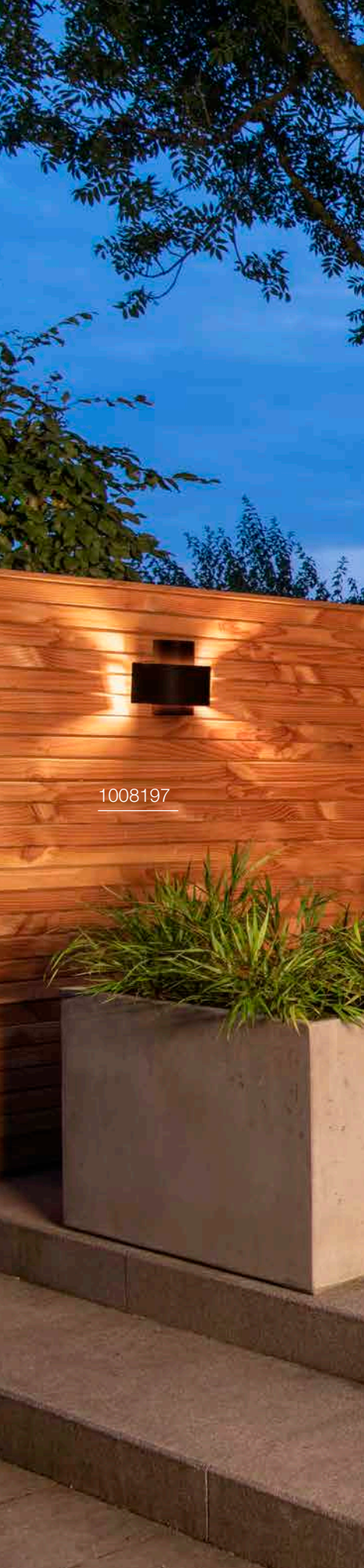

1008197

PHOTONI CYL
WL, E27

PHOTONI
WL, E27



UPDATE

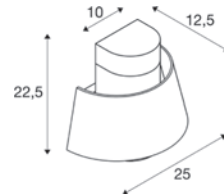
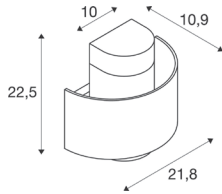

220-240 V ~50/60 Hz
Material: aluminium

220-240 V ~50/60 Hz
Material: aluminium



Base: 1xE27 max. Ø: 6 cm | L: 11.6 cm

Base: 1xE27 max. Ø: 6 cm | L: 11.6 cm

Options	Prod. no.
● black	1008197 ●
● rust	1008198 ●

Options	Prod. no.
● black	1007585
● rust	1007581



E27 | 8 W | 180°
720lm | 2700K | EEC = F
8 kW/1000h

Prod. no.: 1005305



E27 | 8 W | 240°
880lm | 3000K | EEC = E
8 kW/1000h

Prod. no.: 1005289





MODELA

WL, up/down, PHASE

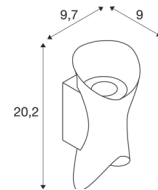

220-240 V ~50/60 Hz | 95 mA
Total wattage: 7.5 W
Material: aluminium

1007809



Up 405 lm | 2700 K
Down 405 lm

Options	Prod. no.
● black/gold 810 lm	1007807
● black 770 lm	1007808
● white/gold 810 lm	1007806
○ white 800 lm	1007809

LID I
WL, single, PHASE

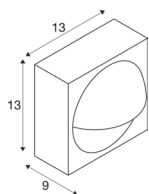

220-240 V ~50/60 Hz | 350 mA
Total wattage: 15 W
Material: aluminium

- The light colour must be set prior to installation



900 lm | 2700 K | 1050 lm | 3000 K

Options

- anthracite

Prod. no.

1007667

LID I
WL, double, PHASE

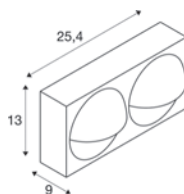

220-240 V ~50/60 Hz | 700 mA
Total wattage: 29 W
Material: aluminium

- The light colour must be set prior to installation



Direct 1 850 lm | 2700 K | 1000 lm | 3000 K
Direct 2 850 lm | 2700 K | 1000 lm | 3000 K

Options

- anthracite

Prod. no.

1007668





LID II

WL, single, PHASE

LID II

WL. up/down, PHASE

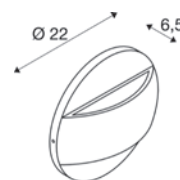
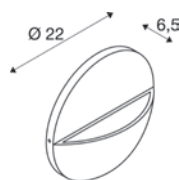

220-240 V ~50/60 Hz | 350 mA
Total wattage: 15 W
Material: aluminium

220-240 V ~50/60 Hz | 700 mA
Total wattage: 28 W
Material: aluminium

- The light colour must be set prior to installation

- The light colour must be set prior to installation



800lm|2700 K | 800lm|3000 K



Up 750lm|2700 K | 750lm|3000 K
Down 750lm|2700 K | 750lm|3000 K

Options

- anthracite

Prod. no.

1007282

Options

- anthracite

Prod. no.

1007281

1007281

Q-RING
WL, PHASE

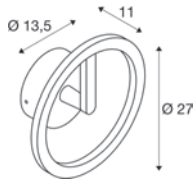

220-240 V ~50/60 Hz | 240 mA
Total wattage: 10 W
Material: aluminium/plastic



950 lm | 3000 K

Options	Prod. no.
● black	1007918
○ white	1007919

Q-RING
WL. Sensor

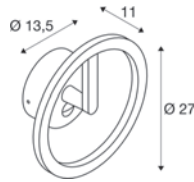

220-240 V ~50/60 Hz | 240 mA
Total wattage: 10 W
Material: aluminium/plastic

- PIR sensor, adjustable range 10-2000lx and 8 s-8 min. Detection range between 6-10 m depending on the mounting height of the light



950 lm | 3000 K

Options	Prod. no.
● black	1007916
○ white	1007917

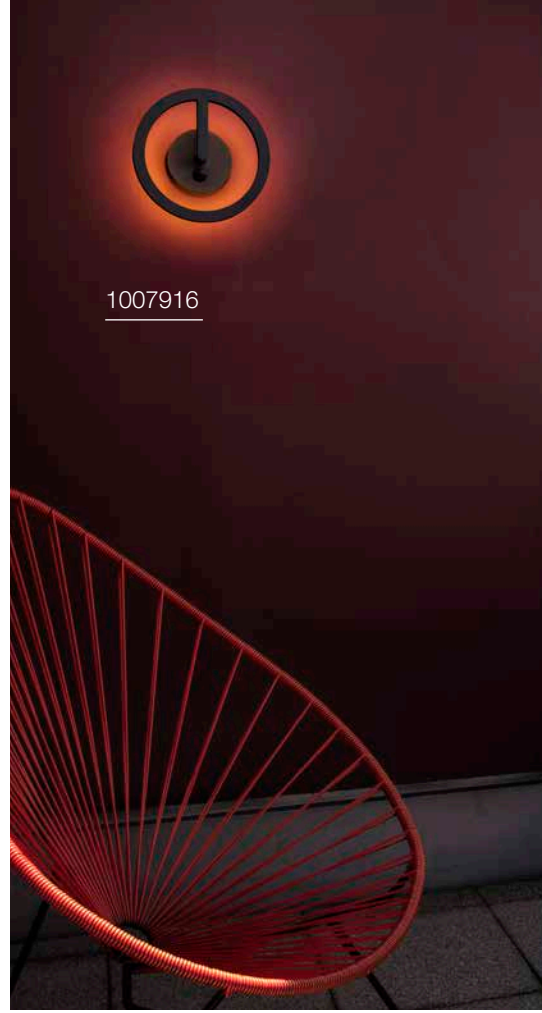

1007916

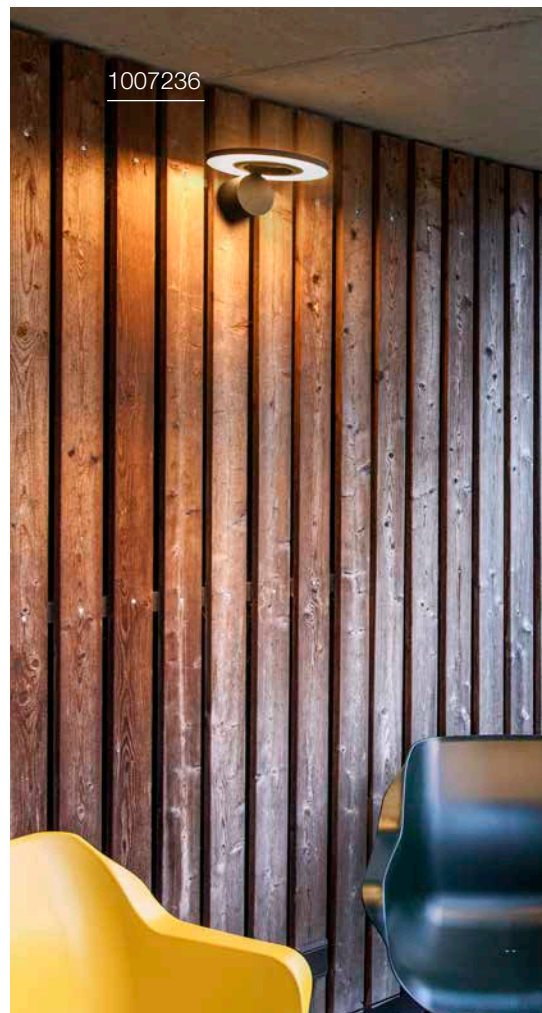

1007236



I-RING WL

D-RING S WL, PHASE

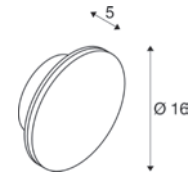

100-240 V ~50/60 Hz | 350 mA
Total wattage: 9.2 W
Material: aluminium



220-240 V ~50/60 Hz | 95 mA
Total wattage: 7.5 W
Material: aluminium

- The light colour must be set prior to installation



670 lm | 3000 K



630 lm | 2700 K | 650 lm | 3000 K

Options	Prod. no.
● anthracite	1007236

Options	Prod. no.
● black 630 lm	1007911
○ white 790 lm	1007912





1007914

D-RING M WL, PHASE

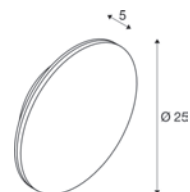

220-240 V ~50/60 Hz | 190 mA

Total wattage: 15 W

Material: aluminium

- The light colour must be set prior to installation



1260lm|2700 K | 1360lm|3000 K

Options	Prod. no.
● black 1260 lm	1007913
○ white 1540 lm	1007914



OVAL 14 WL, up/down

OVAL 18 WL, up/down

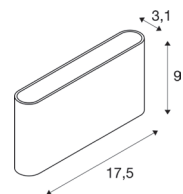
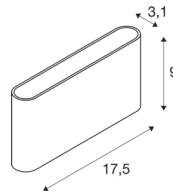

220-240 V ~50/60 Hz | 145 mA
Total wattage: 5.7 W
Material: aluminium/polycarbonate (PC)

220-240 V ~50/60 Hz | 275 mA
Total wattage: 9.3 W
Material: aluminium/polycarbonate (PC)

- The light colour must be set prior to installation

- The light colour must be set prior to installation



Up	280 lm	2700 K	3000 K
Down	280 lm		

Up	430 lm	2700 K	3000 K
Down	430 lm		

Options	Prod. no.
● black/frosted	1007142
○ white/frosted	1007143

Options	Prod. no.
● black/frosted	1007144
○ white/frosted	1007145

1007142

CONCRETO M
WL

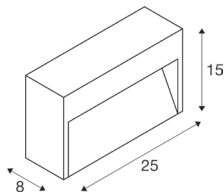

220-240 V ~50/60 Hz | 700 mA
Total wattage: 8.5 W
Material: concrete/aluminium

CONCRETO L
WL

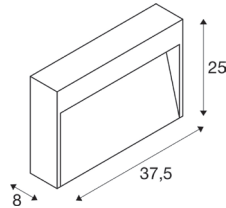

220-240 V ~50/60 Hz | 700 mA
Total wattage: 12 W
Material: concrete/aluminium



Asymmetrical 270 lm | 3000 K

Options	Prod. no.
● grey/black	1006404



Asymmetrical 470 lm | 3000 K

Options	Prod. no.
● grey/black	1006405

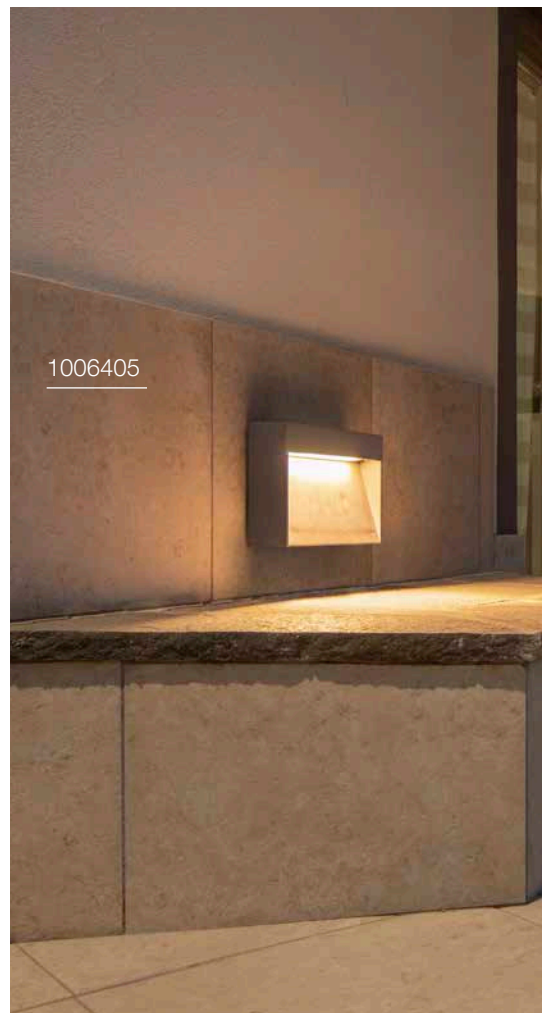



1008384



RASTERLYS WL, PHASE

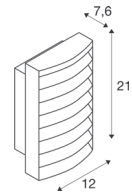

220-240 V ~0/50/60 Hz | 350 mA
Total wattage: 14 W
Material: aluminium

- The light colour must be set prior to installation
- Suitable for DC operation



350 lm | 2700 K | 400 lm | 3000 K

Options	Prod. no.
● anthracite	1008384



T-TUBE WL GU10, single, Sensor

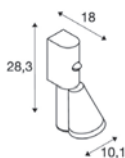

220-240 V ~50/60 Hz
Material: aluminium

- PIR sensor, adjustable range 10-2000lx and 5s-10min. Detection range up to 8 m depending on the mounting height of the light



Base: 1xGU10 max. Ø: 5.1 cm | L: 5.5 cm

Options

Prod. no.

- black

1008010 ●



GU10 | 6W | 38°
450 lm | 2700K | EEC = F
6 kW/1000h



Prod. no.: **1005077**

T-TUBE WL GU10, double, Sensor

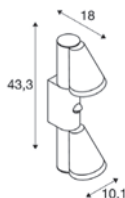

220-240 V ~50/60 Hz
Material: aluminium

- Lower luminaire head 90° - Upper luminaire head 180° swivelling
- PIR sensor, adjustable range 10-2000lx and 5s-10min. Detection range up to 8 m depending on the mounting height of the light



Base: 1xGU10 max. Ø: 5.1 cm | L: 5.5 cm

Options

Prod. no.

- black

1008011 ●



GU10 | 6W | 38°
450 lm | 2700K | EEC = F
6 kW/1000h



Prod. no.: **1005077**

1008010





T-TUBE WL GU10, single

T-TUBE WL GU10, double



UPDATE

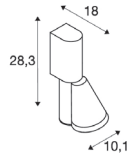

220-240 V ~50/60 Hz
Material: aluminium



UPDATE

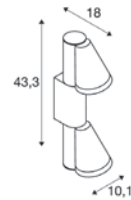

220-240 V ~50/60 Hz
Material: aluminium

- Lower luminaire head 90° – Upper luminaire head 180° swivelling



Base: 1xGU10 max. Ø: 5.1 cm | L: 5.5 cm

Options	Prod. no.
● black	1008012 ●



GU10 | 6W | 38°
450 lm | 2700 K | EEC = F
6 kW/1000h

Prod. no.: 1005077



Base: 1xGU10 max. Ø: 5.1 cm | L: 5.5 cm

Options	Prod. no.
● black	1008013 ●



GU10 | 6W | 38°
450 lm | 2700 K | EEC = F
6 kW/1000h

Prod. no.: 1005077



1007653





S-TUBE CW

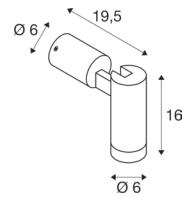

220-240 V ~50/60 Hz
Material: aluminium

- streamlined design



Base: 1xGU10 max. Ø: 5.1 cm | L: 5.5 cm

Options	Prod. no.
● black	1007653



GU10 | 2 W | 36°
230lm | 2700K | EEC = E
3 kW/1000h

Prod. no.: 1007230



FLATT II
WL, PHASE

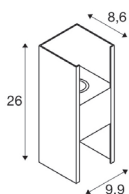

220-240 V ~50/60 Hz | 240 mA
Total wattage: 9.5 W
Material: aluminium



Up 310/320 lm | 2700 K
Down 310/320 lm

Options	Prod. no.
● black 620 lm	1010102
● anthracite/brown 640 lm	1010101

1010107





FLATT II WL, Sensor



NEW

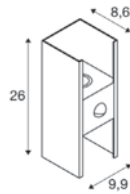

100-240 V ~50/60 Hz | 240 mA
Total wattage: 10 W
Material: aluminium

- Primary and replica functionality. Option to control additional lights without a sensor



Up	310/320lm	2700 K
Down	310/320lm	

Options	Prod. no.
● black 620lm	1010108
● anthracite/brown 640lm	1010107

FLATT WL

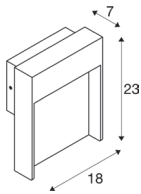

100-240 V ~50/60 Hz | 300 mA
 Total wattage: 13 W
 Material: aluminium



500 lm | 3000 K | 530 lm | 4000 K

Options	Prod. no.
● anthracite 500/530 lm	1002952
● anthracite/brown 500/530 lm	1002953

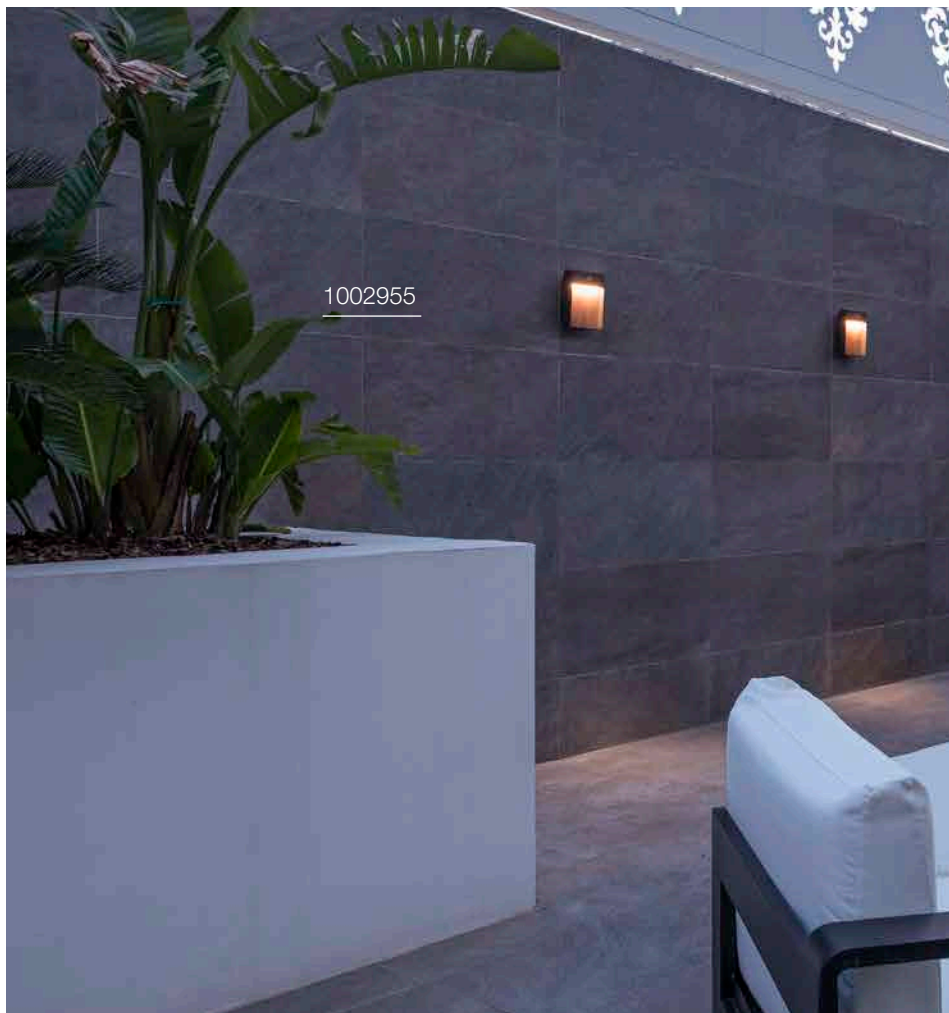

1002955



1002955



FLATT SENSOR WL

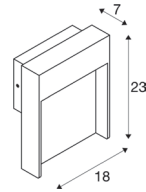

100-240 V ~50/60 Hz | 300 mA
Total wattage: 13 W
Material: aluminium

- PIR sensor, adjustable range 15-2000lx and 5 s-10 min. Detection range between 6-9 m depending on the mounting height of the light



500 lm | 3000 K | 530 lm | 4000 K

Options	Prod. no.
● anthracite 500/530 lm	1002954
● anthracite/brown 500/530 lm	1002955



229532



234515



THEO UP/DOWN WL, QPAR51

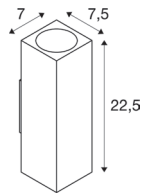

220-240 V ~50/60 Hz
Material: aluminium/glass



Base: 2xGU10

Options	Prod. no.
● anthracite	229535
○ white	229531
● grey	229532



GU10 | 6W | 38°
450 lm | 2700 K | EEC = F
6 kW/1000h



Prod. no.: **1005077**

BIG THEO WL, BEAM UP/FLOOD DOWN

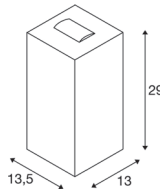

220-240 V ~50/60 Hz | 500 mA
Total wattage: 29 W
Material: aluminium/glass

- The 2° light effect is particularly suitable for contouring and structuring high surfaces and building facades such as hotels, restaurants or even apartment blocks and shopping centres.



Up 130 lm | 3000 K
Down 2000 lm

Options	Prod. no.
● anthracite	234515

BIG THEO UP/DOWN WL, QPAR111

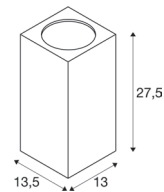

220-240 V ~50/60 Hz
Material: aluminium/glass



Base: 2xGU10

Options	Prod. no.
● anthracite	229575
● grey	229574



GU10 | 13 W | 12°
650 lm | 3000 K | EEC = F
13 kW/1000h



Prod. no.: **1005278**

THEO
WL, QPAR51

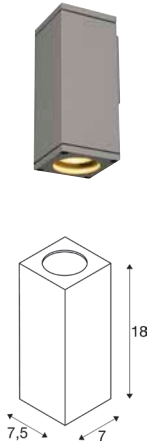

220-240 V ~50/60 Hz
Material: aluminium/glass



Base: 1xGU10

Options	Prod. no.
● anthracite	229525
● grey	229524



GU10 | 6 W | 38°
450 lm | 2700 K | EEC = F
6 kW/1000h



Prod. no.: 1005077

BIG THEO
FLOOD UP/DOWN
WL

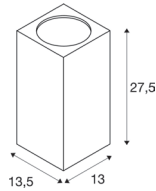

220-240 V ~50/60 Hz | 1000 mA
Total wattage: 42 W
Material: aluminium/glass



Up 2000 lm | 3000 K
Down 2000 lm

Options	Prod. no.
● anthracite	234505





BIG THEO WL, QPAR111

BIG THEO WL

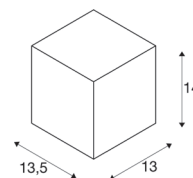
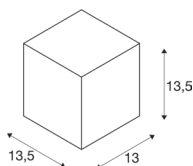
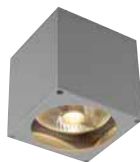

220-240 V ~50/60 Hz
Material: aluminium/glass



100-277 V ~50/60 Hz | 500 mA
Total wattage: 21 W
Material: aluminium/glass



Base: 1xGU10



2000lm|3000 K

Options	Prod. no.
● anthracite	229565
● grey	229564

Options	Prod. no.
● anthracite	234525



GU10 | 13 W | 12°
650 lm | 3000 K | EEC = F
13 kW/1000h



Prod. no.: 1005278



234525



1010179

33





THEO PRO S

WL, single, DALI P1

THEO PRO S

WL, up/down, DALI P1

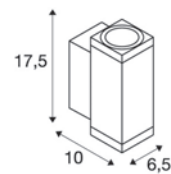
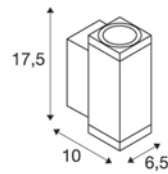

220-240 V ~50/60 Hz | 340 mA
Total wattage: 3 W
Material: aluminium

- Conveniently adjustable light distribution using 10° interchangeable optics
- incl. 1 slide for asym. light distribution
- Optimised frame end design due to uniform dimensions and luminous flux (up and up/down) within one version



220-240 V ~50/60 Hz | 385 mA
Total wattage: 6 W
Material: aluminium

- Conveniently adjustable light distribution using 10° interchangeable optics
- incl. 1 slide for asym. light distribution
- Optimised frame end design due to uniform dimensions and luminous flux (up and up/down) within one version



Down 300lm | 2700K



Up 300lm | 2700K
Down 300lm | 2700K

Options	Prod. no.
● anthracite	1010177 ●
○ white	1010178 ●

Options	Prod. no.
● anthracite	1010179 ●
○ white	1010180 ●

Adler
Hotel & Spa

1010183



THEO PRO S

WL, single, DALI P2



NEW

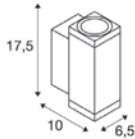

220-240 V ~50/60 Hz | 150 mA
Total wattage: 6 W
Material: aluminium

- Conveniently adjustable light distribution using 10° interchangeable optics
- incl. 1 slide for asym. light distribution
- Optimised frame end design due to uniform dimensions and luminous flux (up and up/down) within one version



Down 600lm | 2700K

Options	Prod. no.
● anthracite	1010181 ●
○ white	1010182 ●

THEO PRO S

WL, up/down, DALI P2



NEW

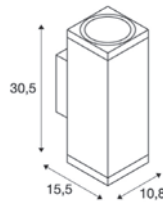

220-240 V ~50/60 Hz | 285 mA
Total wattage: 12 W
Material: aluminium

- Conveniently adjustable light distribution using 10° interchangeable optics
- incl. 1 slide for asym. light distribution
- Optimised frame end design due to uniform dimensions and luminous flux (up and up/down) within one version



Up 600lm | 2700K
Down 600lm | 2700K

Options	Prod. no.
● anthracite	1010183 ●
○ white	1010184 ●

THEO PRO L

WL, single, DALI P1



NEW

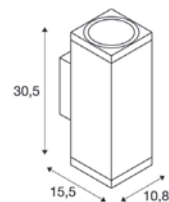

220-240 V ~50/60 Hz | 250 mA
Total wattage: 10 W
Material: aluminium

- Conveniently adjustable light distribution using 10° interchangeable optics
- incl. 1 slide for asym. light distribution
- Optimised frame end design due to uniform dimensions and luminous flux (up and up/down) within one version



Down 1200lm | 2700K

Options	Prod. no.
● anthracite	1010185 ●
○ white	1010186 ●



1010187

THEO PRO L

WL, up/down, DALI P1

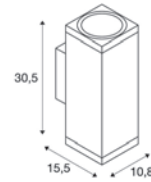

220-240 V ~50/60 Hz | 500 mA
 Total wattage: 20 W
 Material: aluminium

- Conveniently adjustable light distribution using 10° interchangeable optics
- incl. 1 slide for asym. light distribution
- Optimised frame end design due to uniform dimensions and luminous flux (up and up/down) within one version



Up	1200 lm	2700 K
Down	1200 lm	

Options	Prod. no.
● anthracite	1010187 ●
○ white	1010188 ●



THEO PRO L WL, single, DALI P2

THEO PRO L WL, up/down, DALI P2

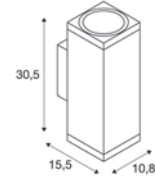
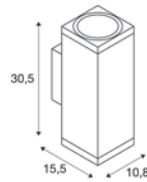

220-240 V ~50/60 Hz | 370 mA
Total wattage: 15 W
Material: aluminium

- Conveniently adjustable light distribution using 10° interchangeable optics
- incl. 1 slide for asym. light distribution
- Optimised frame end design due to uniform dimensions and luminous flux (up and up/down) within one version



220-240 V ~50/60 Hz | 800 mA
Total wattage: 30 W
Material: aluminium

- Conveniently adjustable light distribution using 10° interchangeable optics
- incl. 1 slide for asym. light distribution
- Optimised frame end design due to uniform dimensions and luminous flux (up and up/down) within one version



Down 1800lm | 2700K



Up 1800lm | 2700K
Down 1800lm | 2700K

Options	Prod. no.
<input type="radio"/> white	1010189 ●
<input type="radio"/> white	1010190 ●

Options	Prod. no.
<input type="radio"/> white	1010191 ●
<input type="radio"/> white	1010192 ●



1010163



HELIA PRO S

WL, single, DALI P1

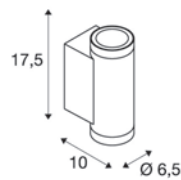

220-240 V ~50/60 Hz | 340 mA
Total wattage: 3 W
Material: aluminium

- Conveniently adjustable light distribution using 10° interchangeable optics
- incl. 1 slide for asym. light distribution
- Optimised frame end design due to uniform dimensions and luminous flux (up and up/down) within one version



Down 300lm | 2700K

Options	Prod. no.
● anthracite	1010161 ●
○ white	1010162 ●

HELIA PRO S

WL, up/down, DALI P1

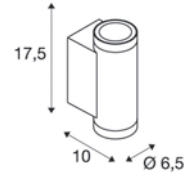

220-240 V ~50/60 Hz | 385 mA
Total wattage: 6 W
Material: aluminium

- Conveniently adjustable light distribution using 10° interchangeable optics
- incl. 1 slide for asym. light distribution
- Optimised frame end design due to uniform dimensions and luminous flux (up and up/down) within one version



Up 300lm | 2700K
Down 300lm | 2700K

Options	Prod. no.
● anthracite	1010163 ●
○ white	1010164 ●

HELIA PRO S

WL, single, DALI P2

HELIA PRO S

WL, up/down, DALI P2

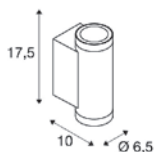

220-240 V ~50/60 Hz | 150 mA
 Total wattage: 6 W
 Material: aluminium

- Conveniently adjustable light distribution using 10° interchangeable optics
- incl. 1 slide for asym. light distribution
- Optimised frame end design due to uniform dimensions and luminous flux (up and up/down) within one version



Down 600 lm | 2700 K

Options	Prod. no.
● anthracite	1010165 ●
○ white	1010166 ●

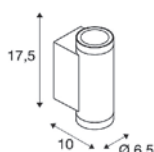

220-240 V ~50/60 Hz | 285 mA
 Total wattage: 12 W
 Material: aluminium

- Conveniently adjustable light distribution using 10° interchangeable optics
- incl. 1 slide for asym. light distribution
- Optimised frame end design due to uniform dimensions and luminous flux (up and up/down) within one version



Up 600 lm | 2700 K
 Down 600 lm

Options	Prod. no.
● anthracite	1010167 ●
○ white	1010168 ●





HELIA PRO L WL, single, DALI P1

HELIA PRO L WL, up/down, DALI P1

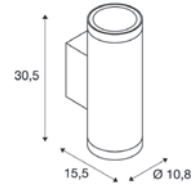
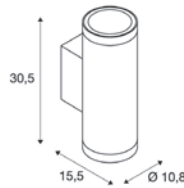

220-240 V ~50/60 Hz | 250 mA
Total wattage: 10 W
Material: aluminium

- Conveniently adjustable light distribution using 10° interchangeable optics
- incl. 1 slide for asym. light distribution
- Optimised frame end design due to uniform dimensions and luminous flux (up and up/down) within one version



220-240 V ~50/60 Hz | 500 mA
Total wattage: 20 W
Material: aluminium

- Conveniently adjustable light distribution using 10° interchangeable optics
- incl. 1 slide for asym. light distribution
- Optimised frame end design due to uniform dimensions and luminous flux (up and up/down) within one version

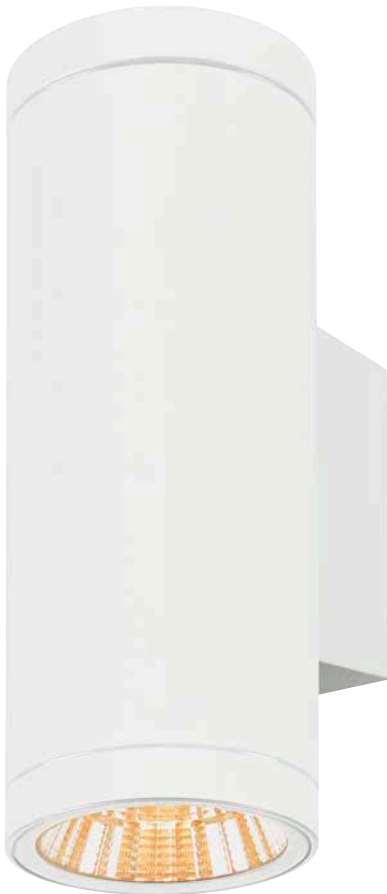

Down 1200lm|2700K

Options	Prod. no.
● anthracite	1010169 ●
○ white	1010170 ●



Up 1200lm|2700K
Down 1200lm

Options	Prod. no.
● anthracite	1010171 ●
○ white	1010172 ●



1010175



HELIA PRO L WL, single, DALI P2

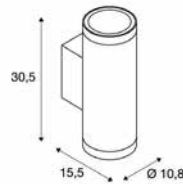

220-240 V ~50/60 Hz | 370 mA
Total wattage: 15 W
Material: aluminium

- Conveniently adjustable light distribution using 10° interchangeable optics
- incl. 1 slide for asym. light distribution
- Optimised frame end design due to uniform dimensions and luminous flux (up and up/down) within one version



Down 1800lm|2700K

Options	Prod. no.
● anthracite	1010173 ●
○ white	1010174 ●

HELIA PRO L WL, up/down, DALI P2

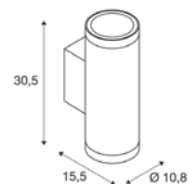

220-240 V ~50/60 Hz | 800 mA
Total wattage: 30 W
Material: aluminium

- Conveniently adjustable light distribution using 10° interchangeable optics
- incl. 1 slide for asym. light distribution
- Optimised frame end design due to uniform dimensions and luminous flux (up and up/down) within one version



Up 1800lm|2700K
Down 1800lm

Options	Prod. no.
● anthracite	1010175 ●
○ white	1010176 ●



1005149



SITRA S

WL, single, square

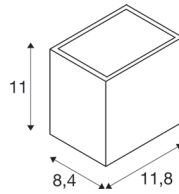

220-240 V ~50/60 Hz | 500 mA
Total wattage: 6.2 W
Material: aluminium/glass



580 lm | 3000 K | 620 lm | 4000 K

Options	Prod. no.
● anthracite	1005148
○ white	1005149
● rust	1005150

SITRA S

WL, single, square

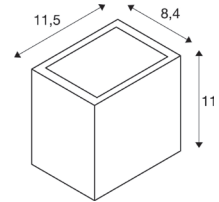

100-277 V ~50/60 Hz | 500 mA
Total wattage: 11 W
Material: aluminium



Up 550 lm | 3000 K | 635 lm | 4000 K
Down 550 lm | 3000 K | 635 lm | 4000 K

Options	Prod. no.
● anthracite	1002032
○ white	1002033
● rust	1002034





232531

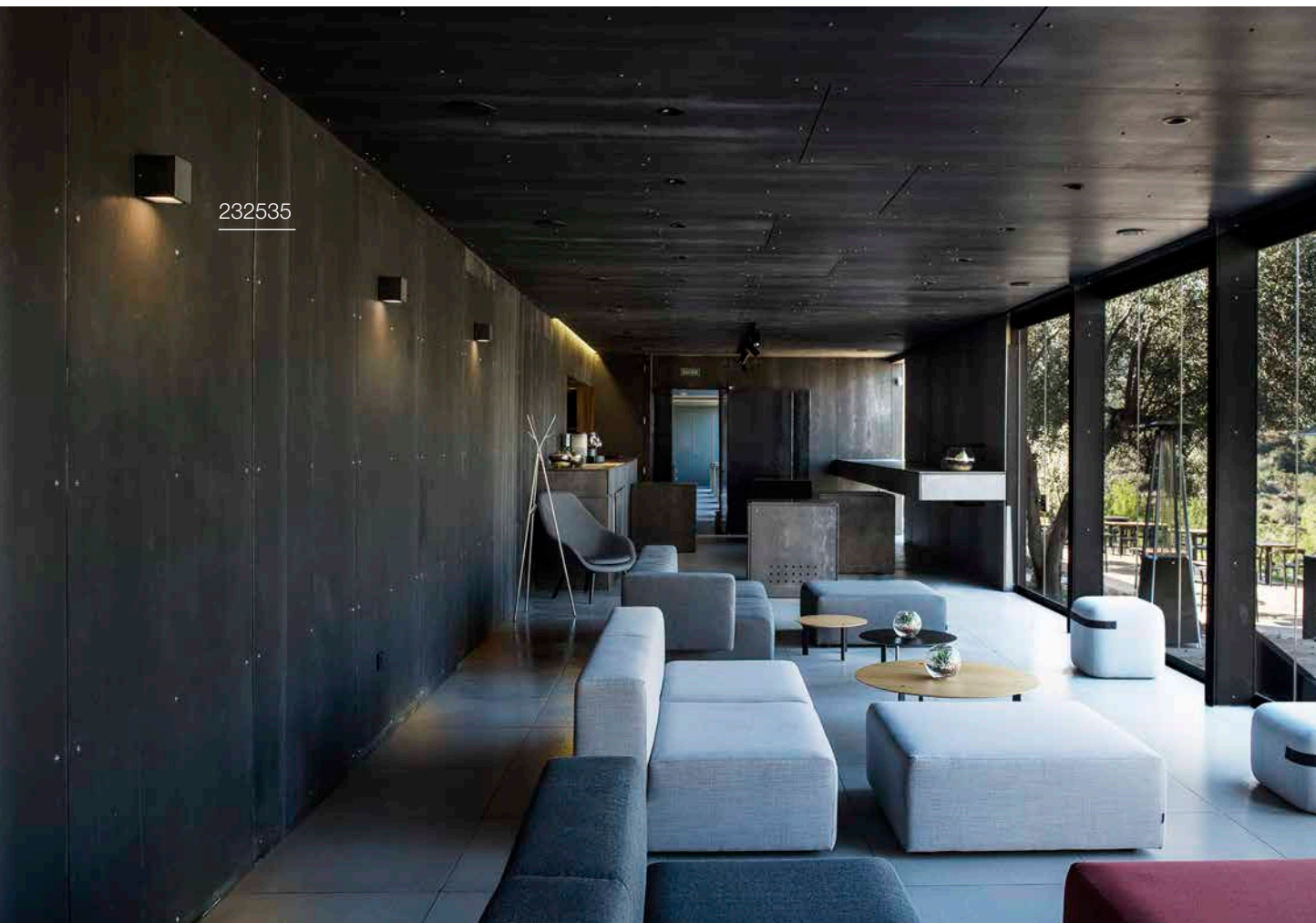

232535



SITRA M

WL, up/down, square

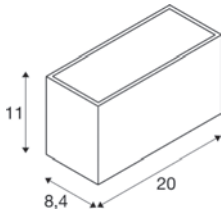

220-240 V ~50/60 Hz | 350 mA
Total wattage: 14 W
Material: aluminium



Up	850 lm	3000 K	940 lm	4000 K
Down	850 lm		940 lm	

Options	Prod. no.
● anthracite	1005151
○ white	1005153
● rust	1005154

SITRA L

WL, up/down, square

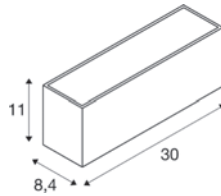

220-240 V ~50/60 Hz | 600 mA
Total wattage: 24 W
Material: aluminium



Up	1400 lm	3000 K	1530 lm	4000 K
Down	1400 lm		1530 lm	

Options	Prod. no.
● anthracite	1005155
○ white	1005156
● rust	1005157

SITRA CUBE

WL, TCR-TSE

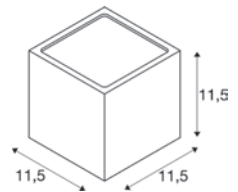

220-240 V ~50/60 Hz
Material: aluminium/glass



Base: 2xG53 max. Ø: 7.5 cm | L: 2.7 cm

Options	Prod. no.
● anthracite	232535
○ white	232531
● rust	232537



GX53 | 6 W | 120°
490 lm | 2700 K | EEC = G
7 kW/1000h



Prod. no.: 1005272

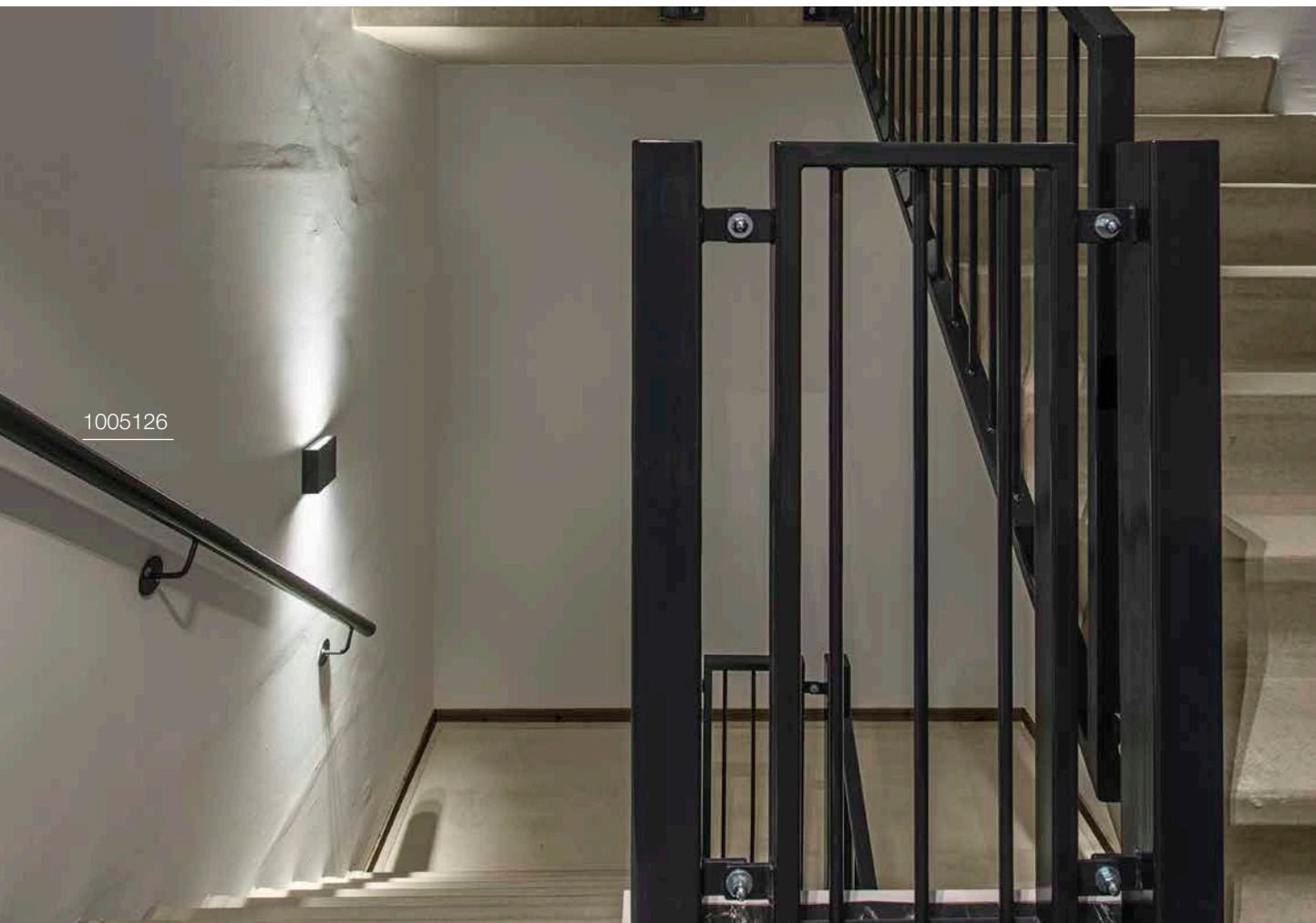



BIG QUAD WL

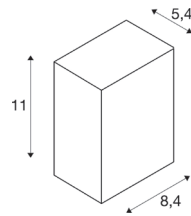

100-240 V ~50/60 Hz | 350 mA
Total wattage: 4.5 W
Material: aluminium/glass



290 lm | 3000 K

Options	Prod. no.
<input checked="" type="radio"/> anthracite 260 lm	232435
<input type="radio"/> white 290 lm	232431

BIG QUAD UP/DOWN WL

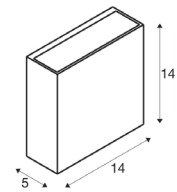

220-240 V ~50/60 Hz | 500 mA
Total wattage: 8.2 W
Material: aluminium/glass



Up 320 lm | 3000 K
Down 320 lm | 3000 K

Options	Prod. no.
<input checked="" type="radio"/> anthracite	1005126
<input type="radio"/> white	1005125

QUAD
WL

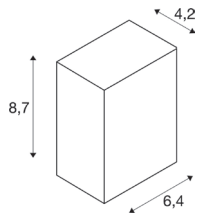

220-240 V ~50/60 Hz | 700 mA
Total wattage: 4.6 W
Material: aluminium/glass



100 lm | 3000 K

Options	Prod. no.
● anthracite 80 lm	232465
○ white 100 lm	232461

QUAD UP/DOWN 15
WL

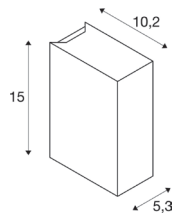

100-277 V ~50/60 Hz | 350 mA
Total wattage: 8 W
Material: aluminium/glass



Up 290 lm | 3000 K
Down 260 lm

Options	Prod. no.
● anthracite 260 lm	232445
○ white 290 lm	232441

232445





RUSTY® UP/DOWN WL, round

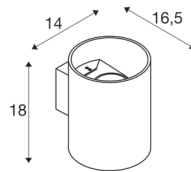

220-240 V ~50/60 Hz | 350 mA
Total wattage: 14 W
Material: FeCSi steel/aluminium



Up 249lm|3000 K | 254 lm|4000 K

Options	Prod. no.
● rust/anthracite	1004651

RUSTY® UP/DOWN WL, square

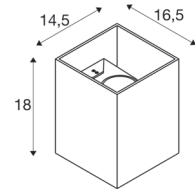

220-240 V ~50/60 Hz | 350 mA
Total wattage: 14 W
Material: FeCSi steel/aluminium



Up 259lm|3000 K | 260 lm|4000 K

Options	Prod. no.
● rust/anthracite	1004650

1004650

1006328



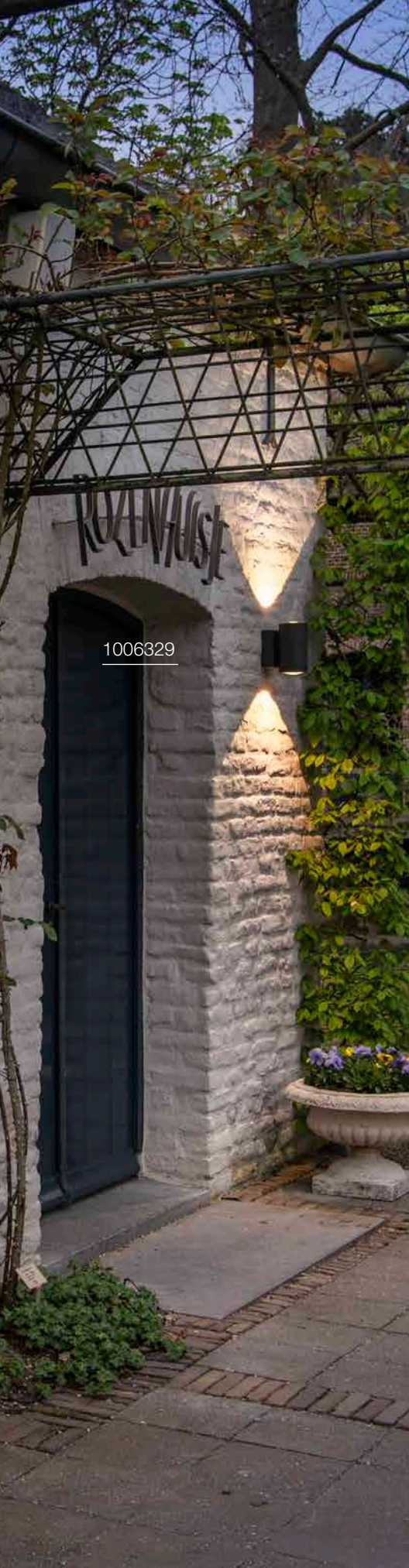

1006329



ENOLA® OCULUS WL, single

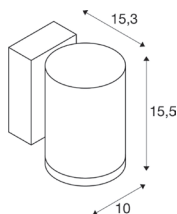

220-240 V ~50/60 Hz | 500 mA
Total wattage: 11 W
Material: aluminium/glass

- The light colour must be set prior to installation
- The Oculus optic creates a contoured, clearly defined light effect on the respective surface



1000 lm | 3000 K | 1100 lm | 4000 K

Options	Prod. no.
● anthracite	1006328



Product	Prod. no.
Spacer	
● anthracite	1002853

ENOLA® OCULUS WL, up/down

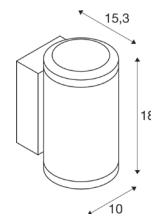

220-240 V ~50/60 Hz | 500 mA
Total wattage: 20 W
Material: aluminium/glass

- The light colour must be set prior to installation
- The Oculus optic creates a contoured, clearly defined light effect on the respective surface



Up 940 lm | 3000 K | 1060 lm | 4000 K
Down 940 lm | 3000 K | 1060 lm | 4000 K

Options	Prod. no.
● anthracite	1006329



Product	Prod. no.
Spacer	
● anthracite	1002853

1003440





ENOLA® ROUND S WL, single

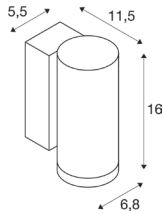

100-240 V ~50/60 Hz | 500 mA
Total wattage: 6 W
Material: aluminium/glass

- The light colour must be set prior to installation
- Conveniently adjustable light distribution using 60° interchangeable optics as an accessory



450 lm | 3000 K | 500 lm | 4000 K

Options	Prod. no.
● anthracite	1003422



Product	Prod. no.
Spacer	
● anthracite	1002853
Reflector 60°	
● chrome	1005262

ENOLA® ROUND M WL, single

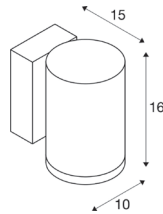

220-240 V ~50/60 Hz | 500 mA
Total wattage: 11 W
Material: aluminium/glass

- The light colour must be set prior to installation
- Conveniently adjustable light distribution using interchangeable 19°, 60° and asymmetric optics as accessories



Up 860 lm | 3000 K | 980 lm | 4000 K
Down 830 lm | 3000 K | 950 lm | 4000 K

Options	Prod. no.
● anthracite	1003423



Product	Prod. no.
Spacer	
● anthracite	1002853
Lens 19°	
● black	1005205
Asymmetrical lens	
● black/chrome	1005206
Reflector 60°	
● chrome	1005207

ENOLA® ROUND L WL, single

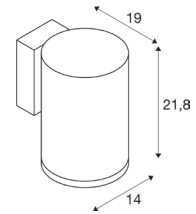

220-240 V ~50/60 Hz | 900 mA
Total wattage: 36 W
Material: aluminium/glass

- The light colour must be set prior to installation
- Conveniently adjustable light distribution using 60° interchangeable optics as an accessory



3300 lm | 3000 K | 3700 lm | 4000 K

Options	Prod. no.
● anthracite	1003440



Product	Prod. no.
Spacer	
● anthracite	1002853
Reflector 60°	
● chrome	1005263



1003441



ENOLA® ROUND S WL, UP/DOWN

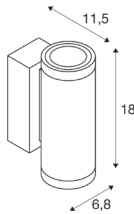

220-240 V ~50/60 Hz | 350 mA
Total wattage: 7.8 W
Material: aluminium/glass

- The light colour must be set prior to installation



Up	310 lm 3000 K	350 lm 4000 K
Down	310 lm 3000 K	350 lm 4000 K

Options	Prod. no.
● anthracite	1003424



Product	Prod. no.
Spacer	
● anthracite	1002853
Reflector 60°	
● chrome	1005262

ENOLA® ROUND M WL, UP/DOWN

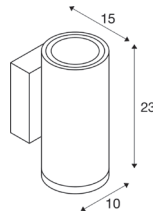

220-240 V ~50/60 Hz | 500 mA
Total wattage: 20 W
Material: aluminium/glass

- The light colour must be set prior to installation
- Conveniently adjustable light distribution using interchangeable 19°, 60° and asymmetric optics as accessories



Up	830 lm 3000 K	900 lm 4000 K
Down	830 lm 3000 K	900 lm 4000 K

Options	Prod. no.
● anthracite	1003425



Product	Prod. no.
Spacer	
● anthracite	1002853
Lens 19°	
● black	1005205
Asymmetrical lens	
● black/chrome	1005206
Reflector 60°	
● chrome	1005207

ENOLA® ROUND L WL, UP/DOWN

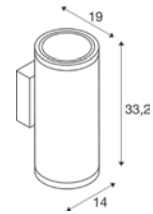

220-240 V ~50/60 Hz | 700 mA
Total wattage: 55 W
Material: aluminium/glass

- The light colour must be set prior to installation
- Conveniently adjustable light distribution using 60° interchangeable optics as an accessory



Up	2700 lm 3000 K	3000 lm 4000 K
Down	2700 lm 3000 K	3000 lm 4000 K

Options	Prod. no.
● anthracite	1003441



Product	Prod. no.
Spacer	
● anthracite	1002853
Reflector 60°	
● chrome	1005263

1003417





ENOLA® SQUARE S WL, single

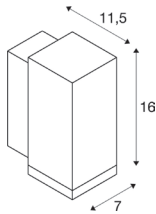

100-240 V ~50/60 Hz | 500 mA
Total wattage: 6 W
Material: aluminium/glass

- The light colour must be set prior to installation
- Conveniently adjustable light distribution using 60° interchangeable optics as an accessory



450 lm | 3000 K | 500 lm | 4000 K

Options	Prod. no.
● anthracite	1003416



Product	Prod. no.
Spacer	
● anthracite	1002853
Reflector 60°	
● chrome	1005262

ENOLA® SQUARE M WL, single

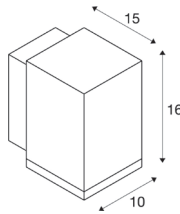

220-240 V ~50/60 Hz | 500 mA
Total wattage: 11 W
Material: aluminium/glass

- The light colour must be set prior to installation
- Conveniently adjustable light distribution using interchangeable 19°, 60° and asymmetric optics as accessories



860 lm | 3000 K | 980 lm | 4000 K

Options	Prod. no.
● anthracite	1003417



Product	Prod. no.
Spacer	
● anthracite	1002853
Lens 19°	
● black	1005205
Asymmetrical lens	
● black/chrome	1005206
Reflector 60°	
● chrome	1005207

ENOLA® SQUARE L WL, single

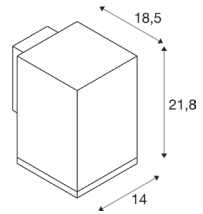

220-240 V ~50/60 Hz | 900 mA
Total wattage: 36 W
Material: aluminium/glass

- The light colour must be set prior to installation
- Conveniently adjustable light distribution using 60° interchangeable optics as an accessory



3300 lm | 3000 K | 3700 lm | 4000 K

Options	Prod. no.
● anthracite	1003437



Product	Prod. no.
Spacer	
● anthracite	1002853
Reflector 60°	
● chrome	1005263

ENOLA® SQUARE S WL, UP/DOWN

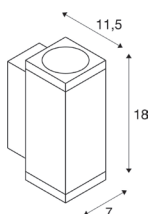

220-240 V ~50/60 Hz | 350 mA

Total wattage: 7.8 W

Material: aluminium/glass

- The light colour must be set prior to installation
- Conveniently adjustable light distribution using 60° interchangeable optics as an accessory



Up	310 lm 3000 K	350 lm 4000 K
Down	310 lm 3000 K	350 lm 4000 K

Options

Prod. no.

- anthracite **1003418**



Product

Prod. no.

- | | |
|---------------|----------------|
| Spacer | |
| ● anthracite | 1002853 |
| Reflector 60° | |
| ● chrome | 1005262 |

ENOLA® SQUARE M WL, UP/DOWN

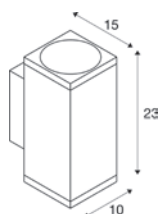

220-240 V ~50/60 Hz | 500 mA

Total wattage: 20 W

Material: aluminium/glass

- The light colour must be set prior to installation
- Conveniently adjustable light distribution using interchangeable 19°, 60° and asymmetric optics as accessories



Up	830 lm 3000 K	950 lm 4000 K
Down	830 lm 3000 K	950 lm 4000 K

Options

Prod. no.

- anthracite **1003419**



Product

Prod. no.

- | | |
|-------------------|----------------|
| Spacer | |
| ● anthracite | 1002853 |
| Lens 19° | |
| ● black | 1005205 |
| Asymmetrical lens | |
| ● black/chrome | 1005206 |
| Reflector 60° | |
| ● chrome | 1005207 |

ENOLA® SQUARE L WL, UP/DOWN

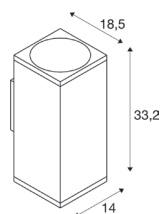

220-240 V ~50/60 Hz | 700 mA

Total wattage: 55 W

Material: aluminium/glass

- The light colour must be set prior to installation
- Conveniently adjustable light distribution using 60° interchangeable optics as an accessory



Up	2700 lm 3000 K	3000 lm 4000 K
Down	2700 lm 3000 K	3000 lm 4000 K

Options

Prod. no.

- anthracite **1003438**



Product

Prod. no.

- | | |
|---------------|----------------|
| Spacer | |
| ● anthracite | 1002853 |
| Reflector 60° | |
| ● chrome | 1005263 |



ENOLA® S/M/L
Reflector



S | H: 1.85 cm Ø: 4.5 cm
M | H: 4 cm Ø: 7.5 cm
L | H: 6.96 cm Ø: 11 cm
 Material: polycarbonate (PC)

Options	Prod. no.
● chrome S	1005262
● chrome M	1005207
● chrome L	1005263

ENOLA® M
Lens 34°



Ø: 7.5 cm
 H: 3.8 cm
 Material: steel/polycarbonate (PC)

Options	Prod. no.
● black	1005205

ENOLA® M
Asymmetrical lens



Ø: 7.5 cm
 H: 3 cm
 Material: steel/polycarbonate (PC)

Options	Prod. no.
● black/chrome	1005206



EASY TO INSTALL

1

WALL MOUNTING.

Screw the mounting plate into the wall with the fixing screw.

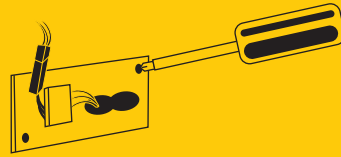

2

SIMPLY PLUG TOGETHER.

Connect the power supply plug connection to the LED lights.

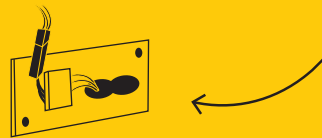

3

SIMPLE AND SECURE ASSEMBLY.

Hook the light into the useful guiding groove on the mounting plate and screw the light body to the mounting plate.



DONE!

Because efficiency always pays off, SLV lights are easy, quick and safe to install. On account of the fixed mounting plates, detachable lamp heads, spring clamps, through wiring, cable entries and various other features, they offer crucial benefits: in that they save you time, effort, and expense.

MOUNTABLE LIGHT HEADS.

With our ENOLA® family, the light head can be separated from the mounting plate attached to the wall. This way, after mounting using the integrated nib and establishing the electrical connection using the plug connection, both hands remain free to securely screw on the lights.



PRACTICAL SPRING CLAMPS.

The cube-shaped SITRA CUBE wall lights offer wonderful modern simplicity. This means they are also fast and simple to install: Simply directly connect the connection cable (no tools required) and connect the mounting plate coupling to the light connector – done!



FEED-THROUGH WIRING.

Our QUADRULO wall and ceiling lights show how simply through-wiring functions in practice. Two cable entries in a figure of 8 configuration are provided in the light's baseplate. In addition to two cable entries, the spring terminal also has two connection options. This means that multiple lights can be quickly and simply installed simultaneously.



GRAFIT
WL, round, sensor, E27

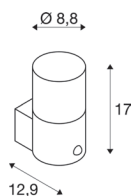

220-240 V ~50/60 Hz
Material: aluminium/acrylic

- PIR sensor, adjustable range 10-2000lx and 8 s-8 min. Detection range between 6-10 m depending on the mounting height of the light



Base: 1xE27 max. Ø: 6 cm | L: 11.5 cm

Options	Prod. no.
● anthracite	1006179



E27 | 8 W | 320°
800 lm | 2700 K | EEC = F
8 kW/1000h



Prod. no.: **1005303**

GRAFIT
WL, round, E27

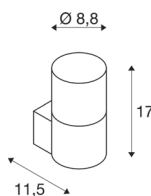

220-240 V ~50/60 Hz
Material: aluminium/acrylic



Base: 1xE27 max. Ø: 6 cm | L: 11.5 cm

Options	Prod. no.
● anthracite	1006178



E27 | 8 W | 320°
800 lm | 2700 K | EEC = F
8 kW/1000h



Prod. no.: **1005303**

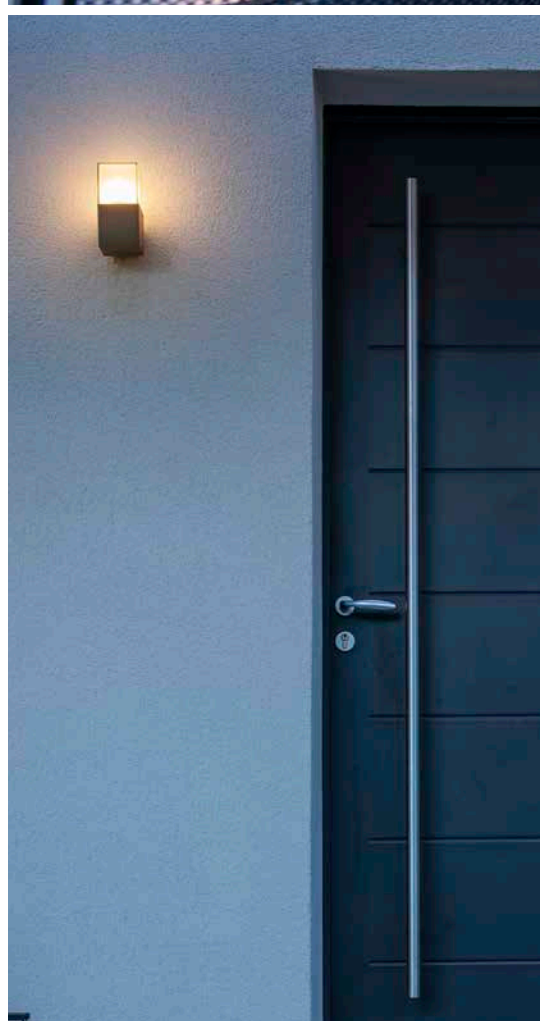
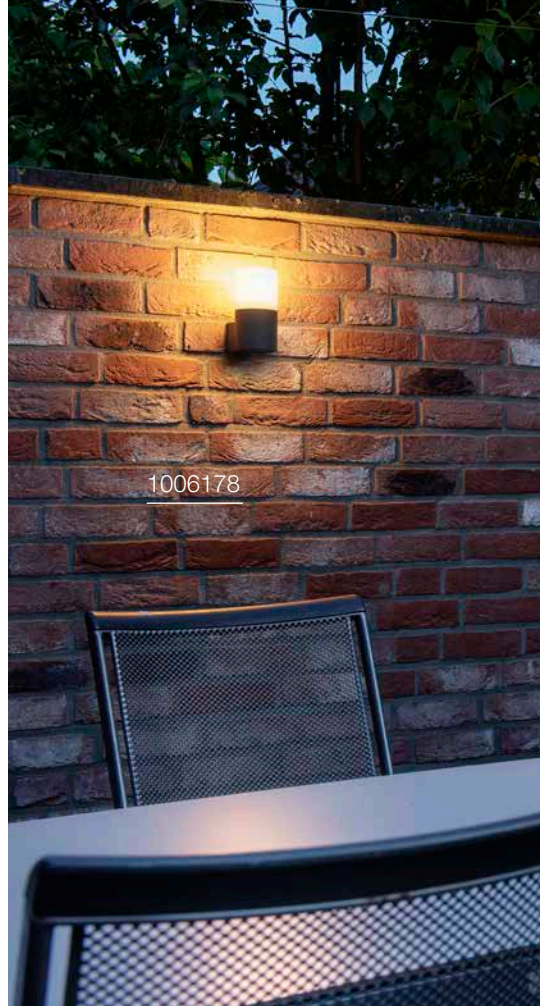



GRAFIT WL, square, sensor, E27

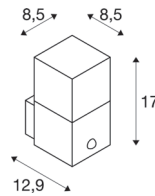

220-240 V ~50/60 Hz
Material: aluminium/acrylic

- PIR sensor, adjustable range 10-2000 lx and 8 s-8 min. Detection range between 6-10 m depending on the mounting height of the light

GRAFIT WL, E27

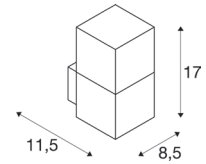

220-240 V ~50/60 Hz
Material: aluminium/plastic



Base: 1xE27 max. Ø: 6 cm | L: 11.5 cm

Options	Prod. no.
● anthracite	1006183



E27 | 13 W | 220°
1300 lm | 2700 K | EEC = F
14 kW/1000h



Prod. no.: **1005302**



Base: 1xE27 max. Ø: 6 cm | L: 11.5 cm

Options	Prod. no.
● anthracite	231205



E27 | 8 W | 320°
800 lm | 2700 K | EEC = F
8 kW/1000h



Prod. no.: **1005303**

231205



1000336

SQUARE WL, E27

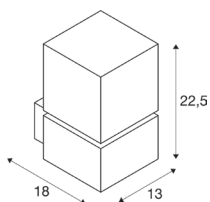

220-240 V ~50/60 Hz
Material: stainless steel 304



1002402



Base: 1xE27 max. Ø: 7 cm L: 13 cm

Options	Prod. no.
● stainless steel	1000336



E27 | 4 W | 280°
830 lm | 2700 K | EEC = A
4 kW/1000h



Prod. no.: 1008641

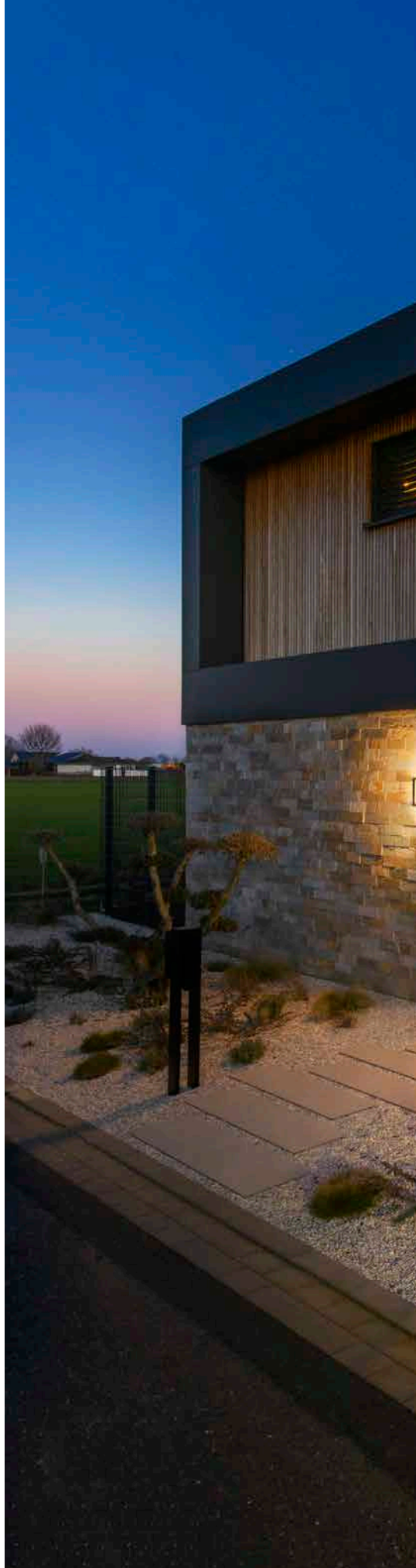



1007207



QUADRULO WL

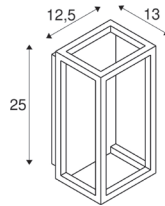

100-277 V ~50/60 Hz | 350 mA
Total wattage: 7.4 W
Material: aluminium/acrylic



270 lm | 3000 K

Options	Prod. no.
● anthracite/brown 280 lm	1007207
● anthracite 270 lm	1005201

QUADRULO SENSOR WL, E27

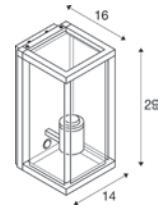

220-240 V ~50/60 Hz
Material: aluminium/glass

- PIR sensor, detection range up to 8 m depending on the mounting height of the light



Base: 1xE27 max. Ø: 8 cm | L: 18 cm

Options	Prod. no.
● anthracite	1002402



E27 | 8 W | 320°
700 lm | 2500 K | EEC = F
8 kW/1000h

Prod. no.: **1005265**



1002403



1005202

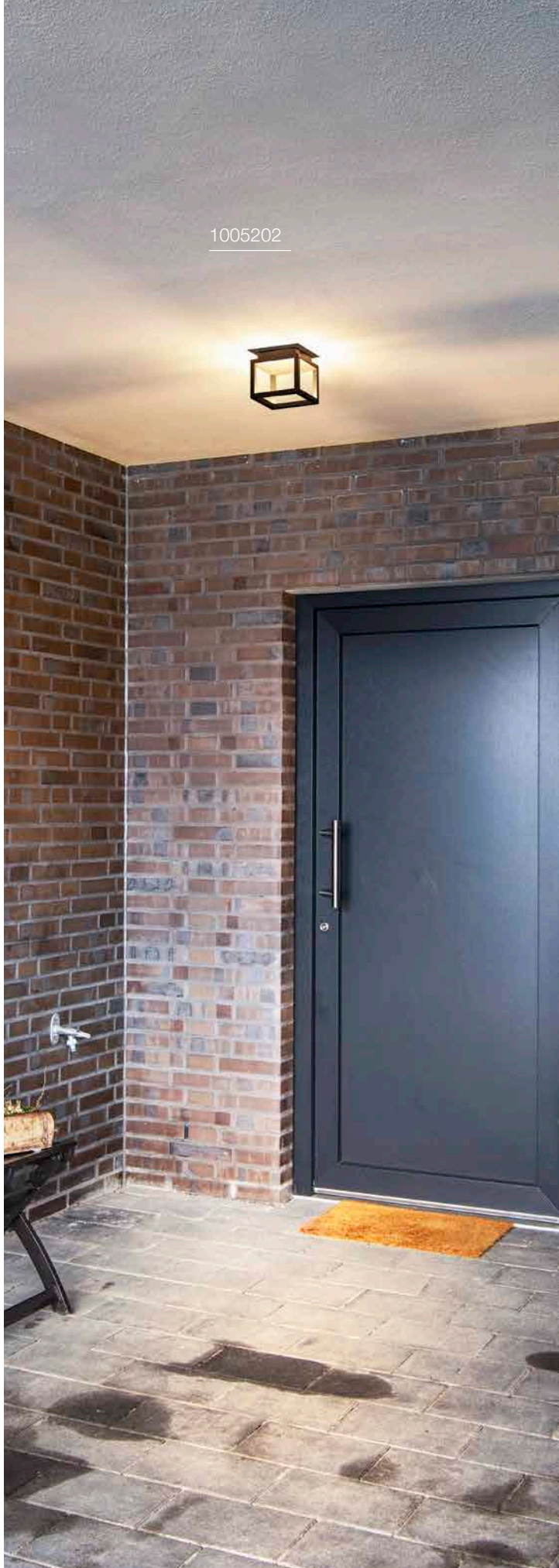



QUADRULO WL, E27

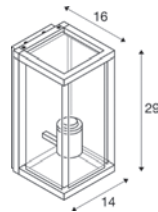

220-240 V ~50/60 Hz
Material: aluminium/glass



Base: 1xE27 max. Ø: 8 cm | L: 18 cm

Options	Prod. no.
● anthracite	1002403



E27 | 8 W | 320°
800lm | 2700 K | EEC = F
8 kW/1000h

Prod. no.: 1005268



QUADRULO CL

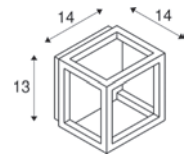
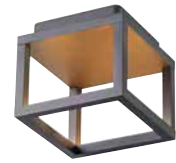

100-277 V ~50/60 Hz | 480 mA
Total wattage: 7.5 W
Material: aluminium/acrylic



230lm|3000 K

Options	Prod. no.
● anthracite	1005202

MERIDIAN BOX

WL, E27

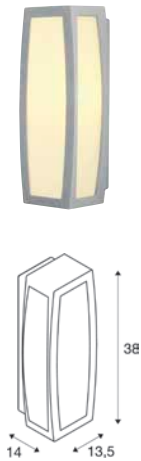

220-240 V ~50/60 Hz
Material: aluminium/polycarbonate (PC)



Base: 1xE27 max. Ø: 7 cm L: 17.5 cm

Options	Prod. no.
● anthracite	230045
● grey	230044



E27 | 14 W | 240°
1520 lm | 3000 K | EEC = E
14 kW/1000h



Prod. no.: 1005307

MERIDIAN

WL, E27

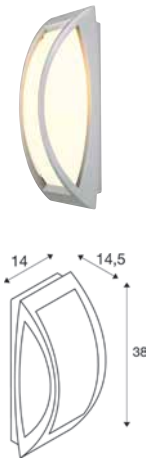

220-240 V ~50/60 Hz
Material: aluminium/polycarbonate (PC)



Base: 1xE27 max. Ø: 7 cm L: 17.5 cm

Options	Prod. no.
● anthracite	230445
● grey	230444



E27 | 8 W | 240°
880 lm | 3000 K | EEC = E
8 kW/1000h



Prod. no.: 1005289

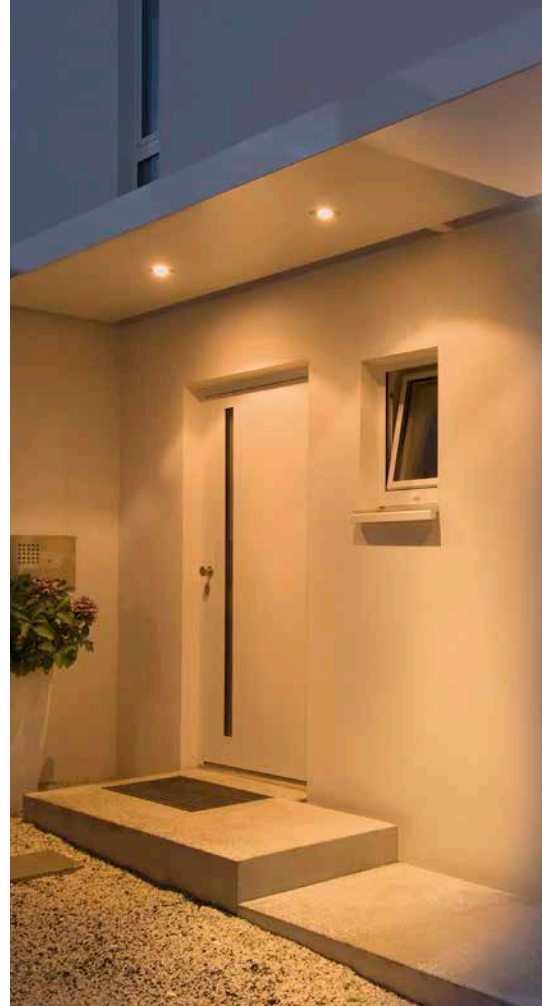



230445

MERIDIAN BOX SENSOR WL, E27

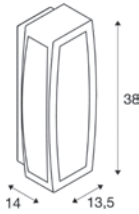

220-240 V ~50/60 Hz
Material: aluminium/polycarbonate (PC)

- The ambient brightness and operating time can be adjusted.



Base: 1xE27 max. Ø: 7 cm | L: 17.5 cm

Options	Prod. no.
● anthracite	230085



E27 | 8 W | 240°
880 lm | 3000 K | EEC = E
8 kW/1000h



Prod. no.: 1005289

MERIDIAN BOX WL, E27

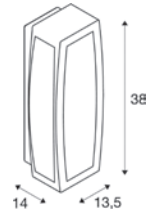

220-240 V ~50/60 Hz
Material: aluminium/polycarbonate (PC)



Base: 1xE27 max. Ø: 7 cm | L: 17.5 cm

Options	Prod. no.
● anthracite	230655
● rust	230657



E27 | 8 W | 320°
800 lm | 2700 K | EEC = F
8 kW/1000h



Prod. no.: 1005268



230655

1004748



1006314

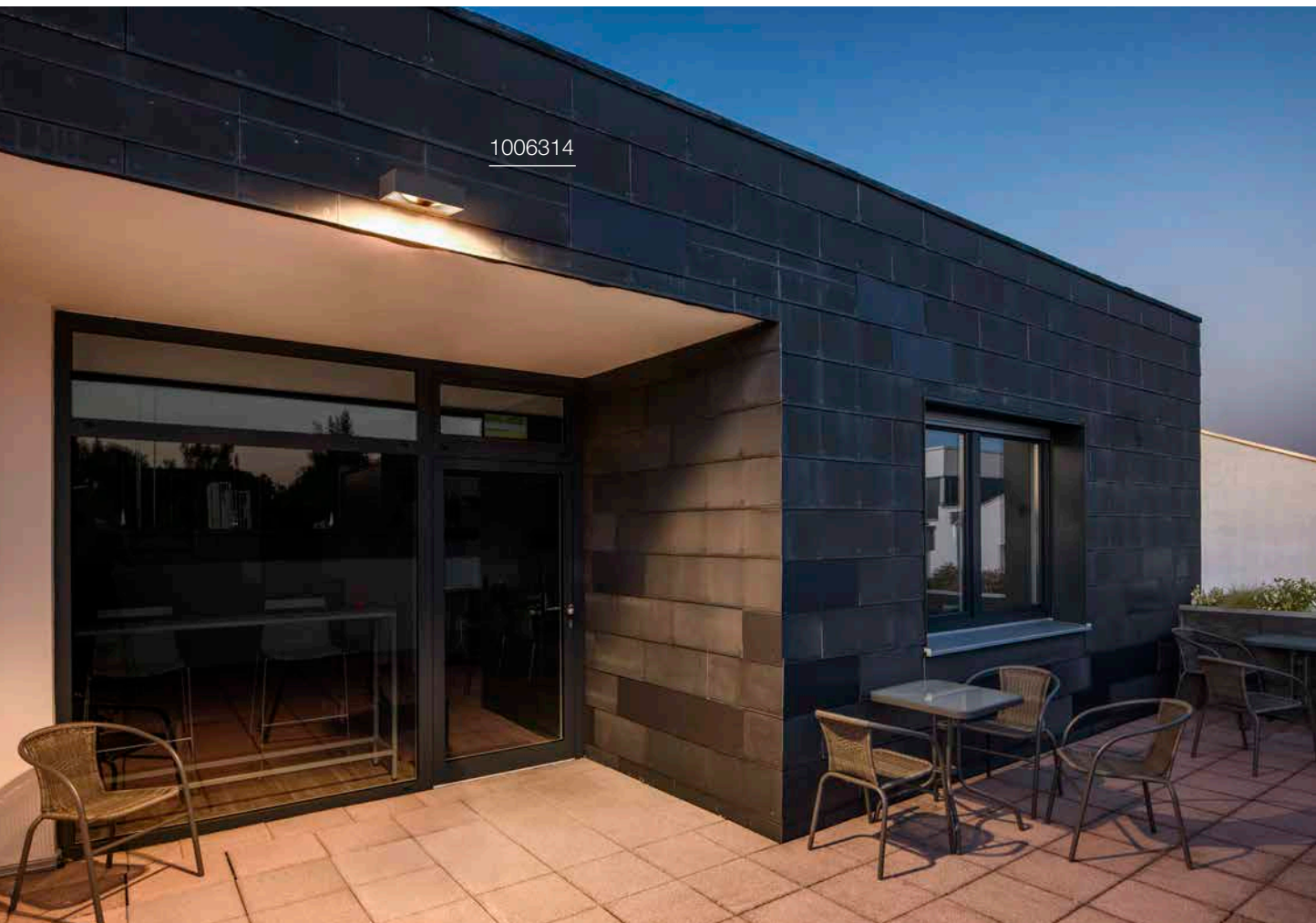



ESKINA FRAME WL

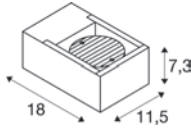

220-240 V ~50/60 Hz | 350 mA
Total wattage: 15 W
Material: aluminium

- The light colour must be set prior to installation



Direct	1100 lm 3000 K	1200 lm 4000 K
--------	------------------	------------------

Options	Prod. no.
● anthracite	1004747

ESKINA FRAME WL, double

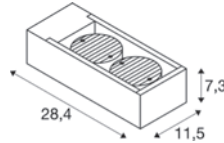

220-240 V ~50/60 Hz | 700 mA
Total wattage: 27 W
Material: aluminium

- The light colour must be set prior to installation



Spot 1	1100 lm 3000 K	1200 lm 4000 K
Spot 2	1100 lm 3000 K	1200 lm 4000 K

Options	Prod. no.
● anthracite	1004748

ESKINA FRAME WL, double

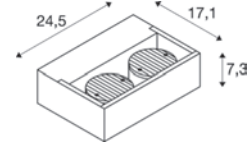

220-240 V ~50/60 Hz | 700 mA
Total wattage: 27 W
Material: aluminium

- The light colour must be set prior to installation



Spot 1	1100 lm 3000 K	1200 lm 4000 K
Spot 2	1100 lm 3000 K	1200 lm 4000 K

Options	Prod. no.
● anthracite	1006314

BOOKAT WL

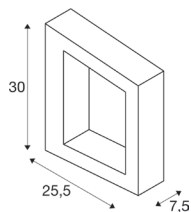

100-277 V ~50/60 Hz | 700 mA
Total wattage: 15 W
Material: aluminium



920 lm | 3000 K | 990 lm | 4000 K

Options

- anthracite

Prod. no.

1005443

TAHA II WL, PHASE



NEW

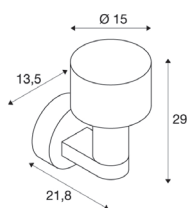

220-240 V ~50/60 Hz | 240 mA
Total wattage: 10 W
Material: aluminium



450 lm | 2200 K | 500 lm | 2700 K

Options

- black

Prod. no.

1010195 ●

TAHA II WL, Sensor



NEW

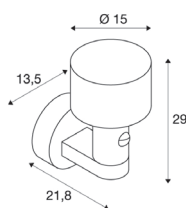

220-240 V ~50/60 Hz | 240 mA
Total wattage: 10 W
Material: aluminium



450 lm | 2200 K | 500 lm | 2700 K

Options

- black

Prod. no.

1010196 ●

- Primary and replica functionality. Option to control additional lights without a sensor



1005443

OVALISK SENSOR WL

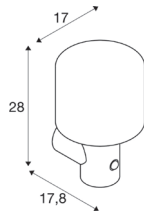

220-240 V ~50/60 Hz | 500 mA
Total wattage: 9.6 W
Material: aluminium/glass

- The light colour must be set prior to installation
- PIR sensor, adjustable range 3-1000 lx and 8 s-12 min. Detection range up to 8 m depending on the mounting height of the light

OVALISK WL

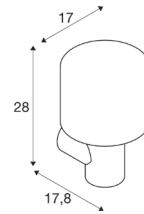

220-240 V ~50/60 Hz | 500 mA
Total wattage: 9.2 W
Material: aluminium/glass

- The light colour must be set prior to installation



1004679



580 lm | 3000 K | 630 lm | 4000 K

Options	Prod. no.
● anthracite	1004679



580 lm | 3000 K | 630 lm | 4000 K

Options	Prod. no.
● anthracite	1004678

PEMA®
WL

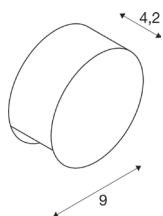

220-240 V ~50/60 Hz
Total wattage: 3.8 W
Material: aluminium



190lm|3000K

Options	Prod. no.
● anthracite	231015
○ white	231010
● grey	231012

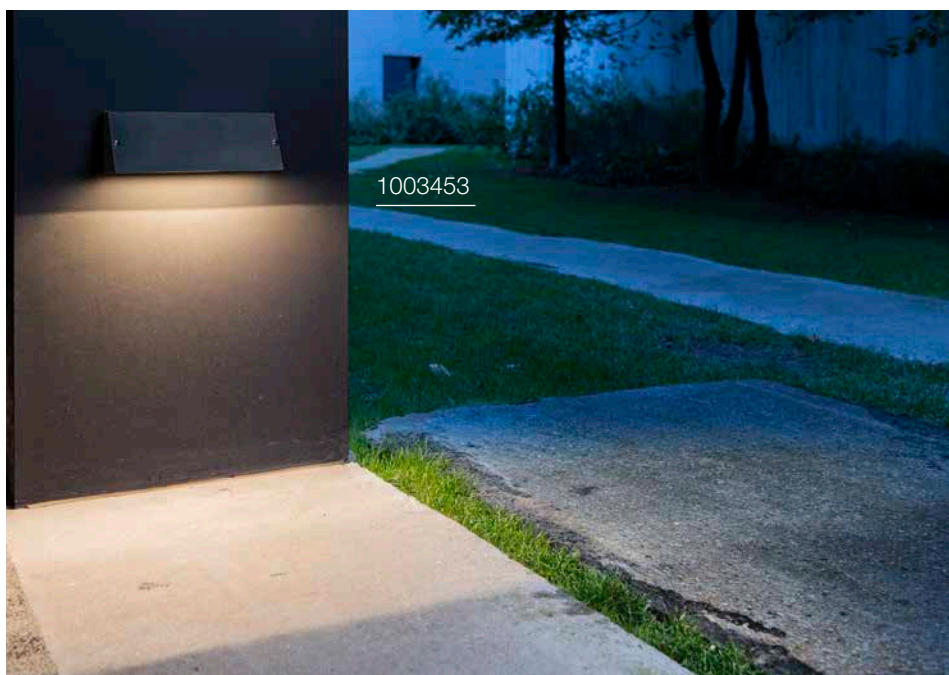



PEMA®
WL

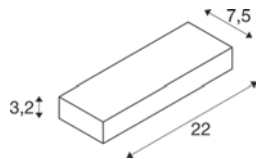

220-240 V ~50/60 Hz
Total wattage: 7.7 W
Material: aluminium/glass



640lm|3000K

Options	Prod. no.
● anthracite	1002069
○ white	1002070

PEMA®
WL

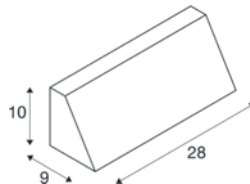

100-277 V ~50/60 Hz | 350 mA
Total wattage: 14 W
Material: aluminium/glass



1340lm|3000K | 1420lm|4000K

Options	Prod. no.
● black	1003453
● grey	1003454

PEMA®
WL, E27

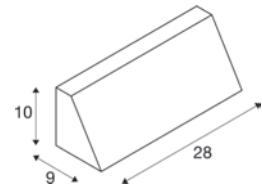

220-240 V ~50/60 Hz
Material: aluminium/glass



Base: 1xE27 max. Ø: 4.5 cm | L: 21 cm

Options	Prod. no.
● black	230030
● grey	230034



E27 | 8 W | 240°
880 lm | 3000 K | EEC = E
8 kW/1000h



Prod. no.: 1005289

ASTINA
WL, QPAR51

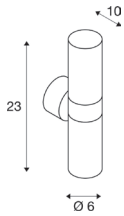

220-240 V ~50/60 Hz
Material: aluminium/glass

ASTINA STEEL
WL, QPAR51

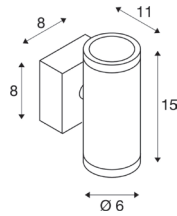

220-240 V ~50/60 Hz
Material: stainless steel 304

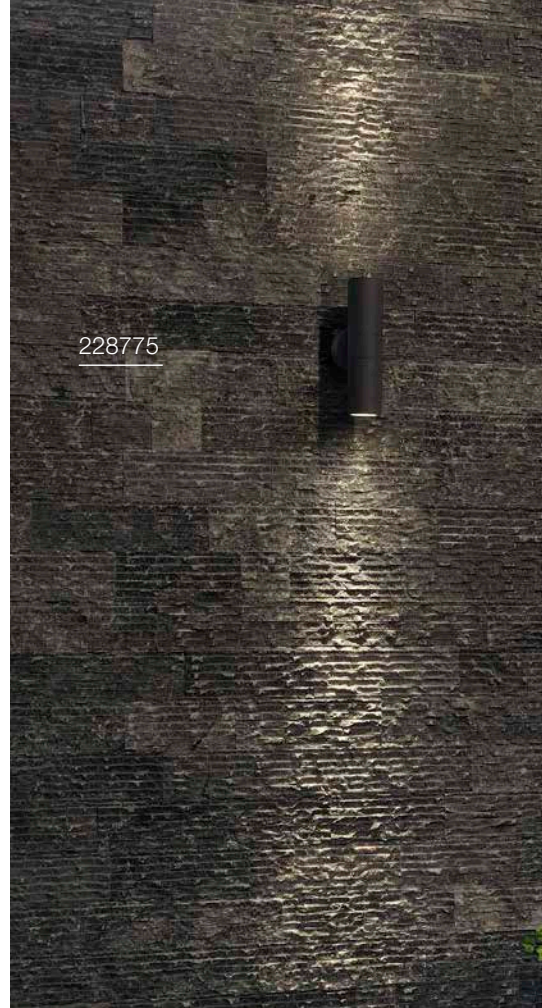

228775



Base: 2xGU10 | L: 9 cm

Options	Prod. no.
● anthracite	228775
○ white	228771
● aluminium	228776



GU10 | 6 W | 36°
360lm | 2200K-2700K | EEC = G
6 kW/1000h

Prod. no.: 1005273



Base: 2xGU10 max. Ø: 5.1 cm | L: 5.7 cm

Options	Prod. no.
● stainless steel	233302



GU10 | 6 W | 36°
360lm | 2200K-2700K | EEC = G
6 kW/1000h

Prod. no.: 1005273





ANGOLUX SENSOR WL

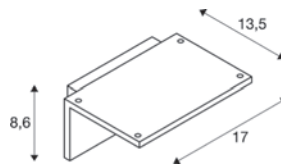

100-240 V ~50/60 Hz | 240 mA
Total wattage: 9.8 W
Material: aluminium

- PIR sensor, adjustable range 10-2000lx and 8s-8min. Detection range between 6-10 m depending on the mounting height of the light
- Protection rating IP44 only when mounted with light emission downwards.

ANGOLUX WL

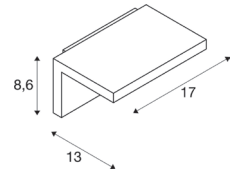

220-240 V ~50/60 Hz | 80 mA
Total wattage: 6.8 W
Material: aluminium

- Protection rating IP44 only when mounted with light emission downwards.



750lm|3000 K



550lm|3000 K

1001969



Options	Prod. no.
● anthracite	1001969
○ white	1001970

Options	Prod. no.
● anthracite	231355
○ white	231351



1002505



VILUA S WL

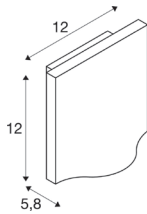

100-277 V ~50/60 Hz | 700 mA
Total wattage: 9 W
Material: aluminium/glass



405lm|3000 K

Options

- anthracite

Prod. no.

1002503

VILUA L WL

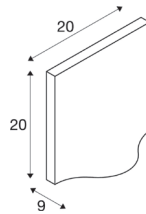

100-277 V ~50/60 Hz | 350 mA
Total wattage: 17 W
Material: aluminium/glass



940lm|3000 K

Options

- anthracite

Prod. no.

1002504

VILUA WL, UP/DOWN

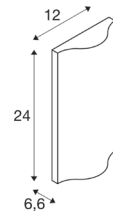

100-277 V ~50/60 Hz | 700 mA
Total wattage: 16 W
Material: aluminium/glass



Up
Down

400lm|3000 K
400lm|3000 K

Options

- anthracite

Prod. no.

1002505

MYRA UP/DOWN WL, QPAR51

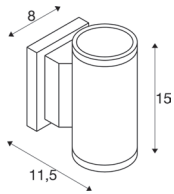

220-240 V ~50/60 Hz
Material: aluminium/glass



Base: 2xGU10 max. Ø: 5.1 cm | L: 5.7 cm

233114

Options	Prod. no.
● anthracite	233115
● grey	233114



GU10 | 6 W | 38°
450 lm | 2700 K | EEC = F
6 kW/1000h



Prod. no.: 1005077



Product	Prod. no.
Surface-mounting frames	
● grey	233214





SITRA
WL, UP/DOWN, TCR-TSE

SITRA
WL, TCR-TSE

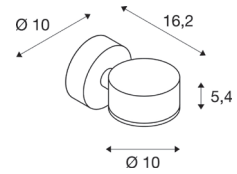
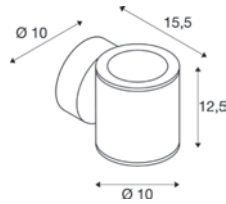

230365



220-240 V ~50/60 Hz
Material: aluminium/glass



220-240 V ~50/60 Hz
Material: aluminium/glass



Base: 2xG53 max. Ø: 7.5 cm | L: 3.5 cm



Base: 1xG53 max. Ø: 7.5 cm | L: 3.5 cm

Options	Prod. no.
● anthracite	230365

Options	Prod. no.
● anthracite	230355



GX53 | 6 W | 120°
490 lm | 2700 K | EEC = G
7 kW/1000h

Prod. no.: 1005272



GX53 | 6 W | 120°
490 lm | 3000 K | EEC = G
7 kW/1000h

Prod. no.: 1005271





1000334



ROX WL, UP/DOWN, QPAR111

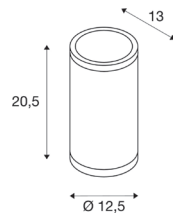

220-240 V ~50/60 Hz
Material: aluminium/glass



Base: 2xGU10

Options	Prod. no.
● aluminium	1000334



GU10 | 12 W | 55°
680 lm | 3000 K | EEC = G
12 kW/1000h

Prod. no.: **1005298**



DELWA WL

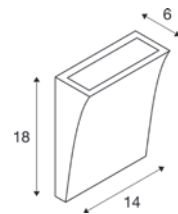

220-240 V ~50/60 Hz | 700 mA
Total wattage: 10 W
Material: aluminium/glass



840lm|3000 K

Options	Prod. no.
● anthracite	1000342
○ white	1000340

WALLYX WL, QPAR51

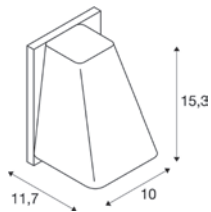

220-240 V ~50/60 Hz
Material: aluminium/glass



Base: 1xGU10 | L: 7.6 cm

Options	Prod. no.
● anthracite	227195



GU10 | 6 W | 38°
450 lm | 2700 K | EEC = F
6 kW/1000h



Prod. no.: 1005077



227195



1002868



DOWNUNDER OUT WL, round

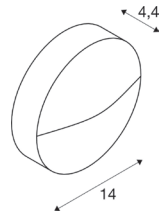

100-240 V ~50/60 Hz | 500 mA
Total wattage: 4.3 W
Material: aluminium



150lm|3000 K | 160lm|4000 K

Options	Prod. no.
● anthracite	1002868

DOWNUNDER OUT WL, square

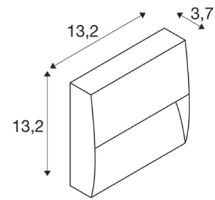

100-240 V ~50/60 Hz | 500 mA
Total wattage: 4.3 W
Material: aluminium



150lm|3000 K | 160lm|4000 K

Options	Prod. no.
● anthracite	1002869

1008542





ABRIDOR HYBRID WL

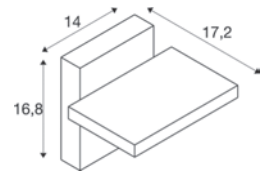

100-240 V ~50/60 Hz | 380 mA

Total wattage: 6.8 W

Material: aluminium

- Solar and 230V operation possible
- 3 different modes
- Battery charging via solar



600lm|2200 K | 650lm|2700 K

Options	Prod. no.
● anthracite	1008542

1002990





ABRIDOR WL

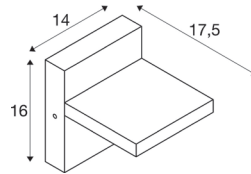

100-240 V ~50/60 Hz | 300 mA
Total wattage: 12 W
Material: aluminium



950 lm | 3000 K | 980 lm | 4000 K

Options

- anthracite

Prod. no.

1002989

ABRIDOR SENSOR WL

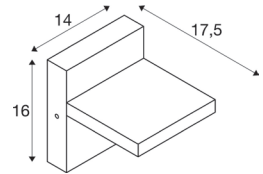

100-240 V ~50/60 Hz | 300 mA
Total wattage: 12 W
Material: aluminium

- PIR sensor, adjustable range 15-2000lx and 5 s-10 min. Detection range between 6-9 m depending on the mounting height of the light



950 lm | 3000 K | 980 lm | 4000 K

Options

- anthracite

Prod. no.

1002990

ORDI II SENSOR WL

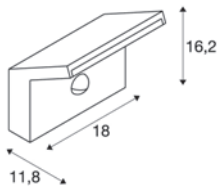

100-240 V ~50/60 Hz | 240 mA

Total wattage: 9.5 W

Material: aluminium

- The light colour must be set prior to installation
- Primary and replica functionality
- PIR sensor, adjustable range 20-2000lx and 8 s-8 min. Detection range between 8-9 m depending on the mounting height of the light



700 lm | 2200 K | 850 lm | 3000 K

Options	Prod. no.
● black 700/850 lm	1008723
○ white 750lm/900lm	1008724

ORDI II WL, PHASE

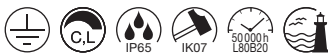
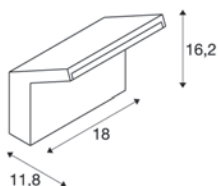

220-240 V ~50/60 Hz | 240 mA

Total wattage: 9.5 W

Material: aluminium

- The light colour must be set prior to installation



700 lm | 2200 K | 850 lm | 3000 K

Options	Prod. no.
● black 700 lm	1008721
○ white 750 lm	1008722

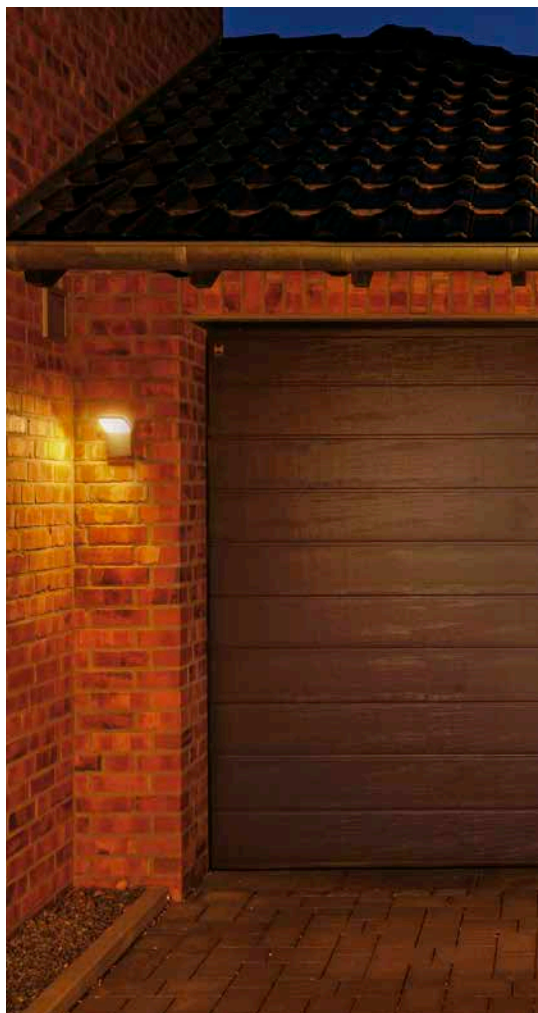



1008723

ORDI WL

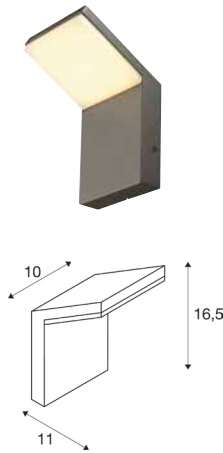

220-240 V ~50/60 Hz | 110 mA
Total wattage: 9 W
Material: aluminium

ORDI SENSOR WL

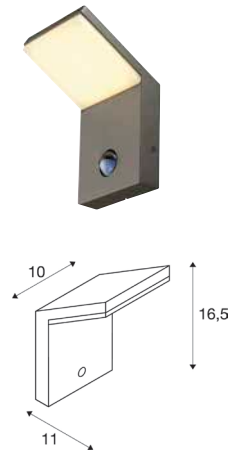

220-240 V ~50/60 Hz | 110 mA
Total wattage: 9 W
Material: aluminium



232905



740lm|3000K

Options	Prod. no.
● anthracite	232905



740lm|3000K

Options	Prod. no.
● anthracite	232915



232495



1002035

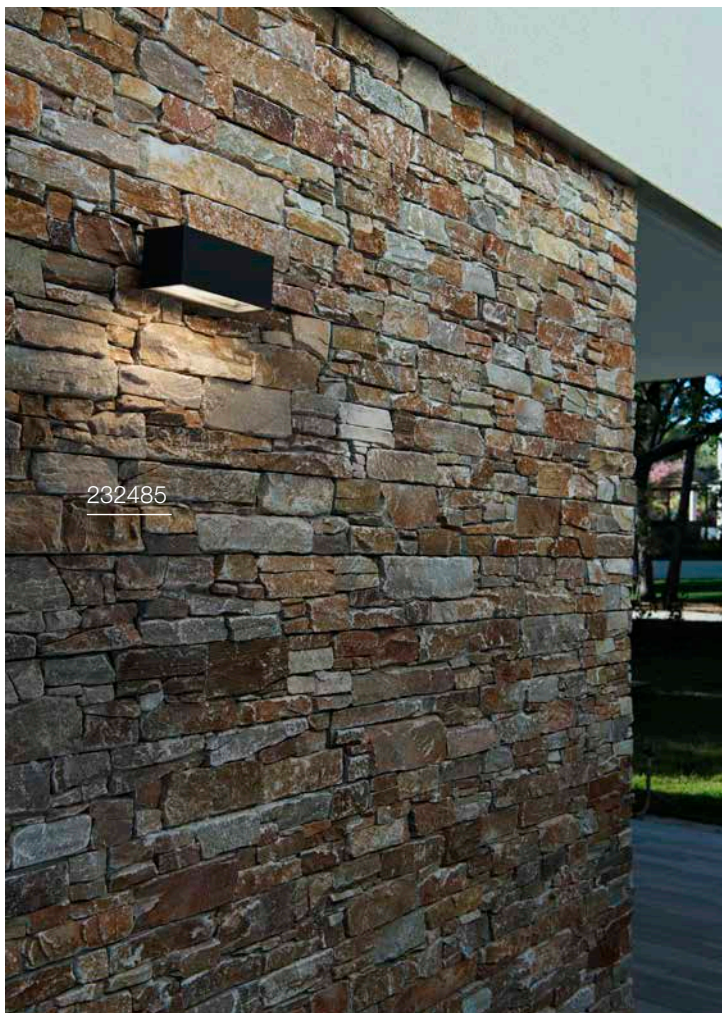

232485



BOX-L WL, E27

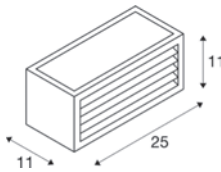

220-240 V ~50/60 Hz
Material: aluminium/acrylic



Base: 1xE27 max. Ø: 6 cm | L: 17.5 cm

Options	Prod. no.
● anthracite	232495
○ white	232491
● rust	232497



E27 | 14 W | 240°
1520 lm | 3000 K | EEC = E
14 kW/1000h



Prod. no.: 1005307

BOX-L WL

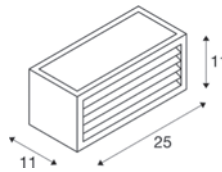

100-277 V ~50/60 Hz | 500 mA
Total wattage: 19 W
Material: aluminium/acrylic



600 lm | 3000 K

Options	Prod. no.
● anthracite	1002035

BOX WL, UP/DOWN, QT-DE12

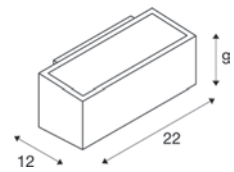

220-240 V ~50/60 Hz
Material: aluminium



Base: 1xR7s 78 mm

Options	Prod. no.
● anthracite	232485



R7s 78mm | 9 W | 330°
1050 lm | 3000 K | EEC = E
9 kW/1000h



Prod. no.: 1005287





LOGS WL

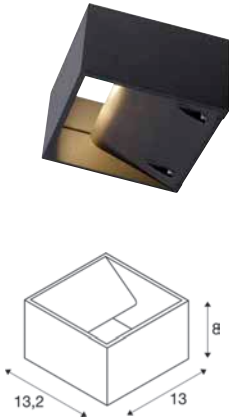

220-240 V ~50/60 Hz | 500 mA
Total wattage: 9.5 W
Material: aluminium



800 lm | 3000 K

Options	Prod. no.
● anthracite 520 lm	232105
○ white 800 lm	232101

OUT-BEAM UP/ FLOOD DOWN WL

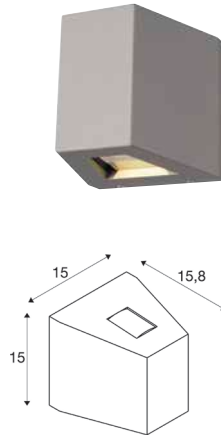

220-240 V ~50/60 Hz | 500 mA
Total wattage: 18 W
Material: aluminium/glass

- The 2° light effect is particularly suitable for contouring and structuring surfaces and building facades.



Down
Beam 690 lm | 3000 K
50 lm

Options	Prod. no.
● anthracite	229665
● grey	229664

L-LINE OUT WL

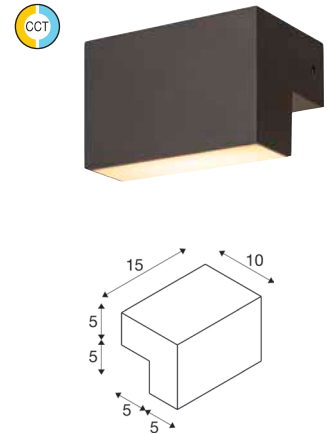

220-240 V ~50/60 Hz | 350 mA
Total wattage: 7 W
Material: aluminium/polycarbonate (PC)

- The light colour must be set prior to installation



500 lm | 3000 K | 570 lm | 4000 K

Options	Prod. no.
● anthracite	1003539



232045



PHOTONIA WL, E27



220-240 V ~50/60 Hz
Material: aluminium/glass



Base: 1xE27 max. Ø: 9 cm | L: 15 cm

Options	Prod. no.
● anthracite	232045



E27 | 8 W | 320°
700 lm | 2500 K | EEC = F
8 kW/1000h

Prod. no.: 1005265

MOLAT WL, E27

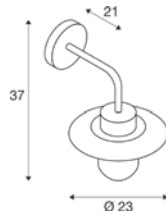

220-240 V ~50/60 Hz
Material: aluminium/glass



Base: 1xE27 max. Ø: 6.5 cm | L: 14.5 cm

Options	Prod. no.
● anthracite	1000820



E27 | 8 W | 320°
800 lm | 2700 K | EEC = F
8 kW/1000h

Prod. no.: 1005303



Product	Prod. no.
Spacer	
● anthracite	1002853

GLOO PURE WL, E27

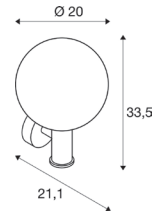

220-240 V ~50/60 Hz
Material: aluminium/glass



Base: 1xE27 max. Ø: 4.8 cm | L: 18 cm

Options	Prod. no.
● anthracite	1002002



E27 | 8 W | 240°
880 lm | 3000 K | EEC = E
8 kW/1000h

Prod. no.: 1005289



F-POL
WL, E27

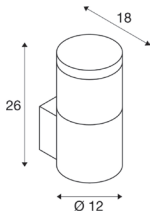

220-240 V ~50/60 Hz
Material: aluminium/polycarbonate (PC)



Base: 1xE27 max. Ø: 5.1 cm | L: 14 cm

Options	Prod. no.
● anthracite	231585



E27 | 8W | 240°
880lm | 3000K | EEC = E
8 kW/1000h



Prod. no.: 1005289

IPERI
WL

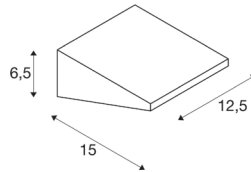

220-240 V ~50/60 Hz
Total wattage: 4.5 W
Material: aluminium



400lm|4000K

Options	Prod. no.
● black	231315

231315

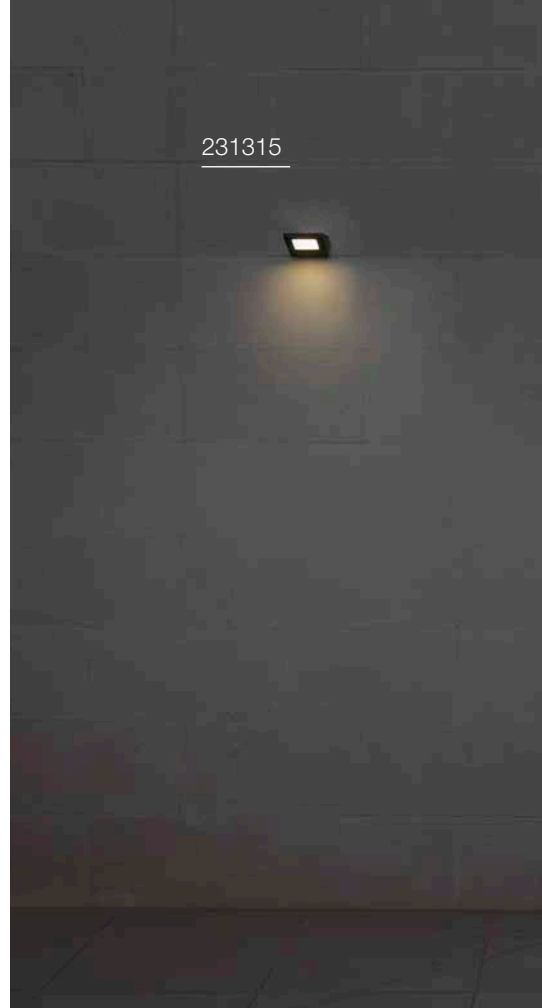



QUADRASYL WL, TCR-TSE

SQUARE TURN WL, G9

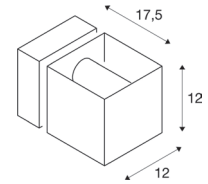
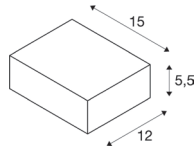
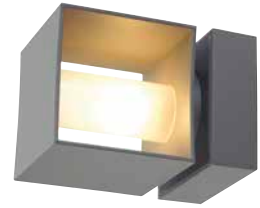

220-240 V ~50/60 Hz
Material: aluminium/glass



220-240 V ~50/60 Hz
Material: aluminium/glass



Base: 1xG53 max. Ø: 7.5 cm | L: 2.7 cm



Base: 1xG9 max. Ø: 3.5 cm | L: 8 cm

Options	Prod. no.
● anthracite	232285

Options	Prod. no.
● grey	100335



GX53 | 6W | 120°
490 lm | 2700 K | EEC = G
7 kW/1000h



Prod. no.: 1005272



G9 | 4 W | 300°
400 lm | 3000 K | EEC = E
4 kW/1000h



Prod. no.: 1005286

1000335



1002905

TODAY PRO Display

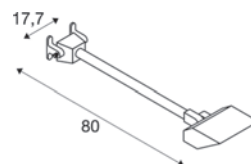

220-240 V ~50/60 Hz | 640 mA
Total wattage: 29 W
Material: aluminium



233134



2800 lm | 4000 K

Options	Prod. no.
● black 2800 lm	1000880
○ white 3400 lm	1000881



ESKINA D

Display, PHASE

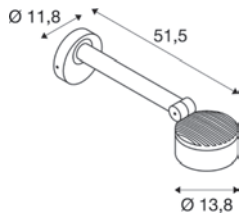

220-240 V ~50/60 Hz | 350 mA
Total wattage: 14.5 W
Material: aluminium

- CCT switch on light head

MYRA DISPLAY

WL, curved, QPAR51

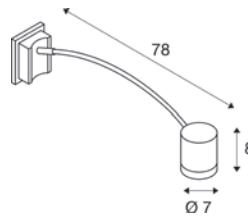

220-240 V ~50/60 Hz
Material: aluminium

MYRA

WL, double, QPAR51

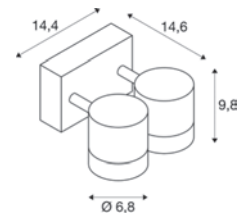

220-240 V ~50/60 Hz
Material: aluminium/glass



1000lm | 3000 K | 4000 K

Options	Prod. no.
● anthracite	1002905



Base: 1xGU10 max. Ø: 5.1 cm | L: 5.7 cm

Options	Prod. no.
● anthracite	233135
● grey	233134



GU10 | 6 W | 38°
450 lm | 2700 K | EEC = F
6 kW/1000h



Prod. no.: 1005077



Base: 2xGU10 max. Ø: 5.1 cm | L: 5.7 cm

Options	Prod. no.
● anthracite	233095



GU10 | 6 W | 38°
450 lm | 2700 K | EEC = F
6 kW/1000h



Prod. no.: 1005077



Product	Prod. no.
Surface-mounting frames	
● grey	233214



Product	Prod. no.
Spacer	
● anthracite	1002853



1004649



233105



LED SPOT SP

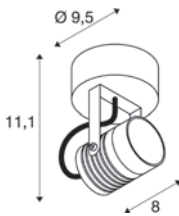

100-240 V ~50/60 Hz | 240 mA
Total wattage: 6 W
Material: aluminium/glass



400lm|3000K

Options

Options	Prod. no.
● anthracite	1004649
● rust	1004957



Product

Product	Prod. no.
NAUTILUS Mounting plate	
● black	1002884

NAUTILUS WL QPAR51

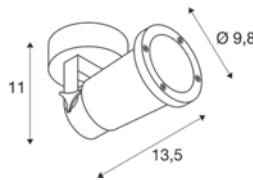

220-240 V ~50/60 Hz
Material: aluminium



Base: 1xGU10 max. Ø: 5.1 cm | L: 8.3 cm

Options

Options	Prod. no.
● black	1002867



GU10 | 6 W | 38°
450 lm | 2700 K | EEC = F
6 kW/1000h

Prod. no.: 1005077



Product

Product	Prod. no.
NAUTILUS Mounting plate	
● black	1002884

MYRA CW, single, QPAR51

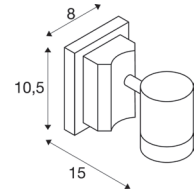

220-240 V ~50/60 Hz
Material: aluminium/glass



Base: 1xGU10 max. Ø: 5.1 cm | L: 5.7 cm

Options

Options	Prod. no.
● anthracite	233105
● grey	233104



GU10 | 6 W | 38°
450 lm | 2700 K | EEC = F
6 kW/1000h

Prod. no.: 1005077



Product

Product	Prod. no.
Surface-mounting frames	
● grey	233214

1002904

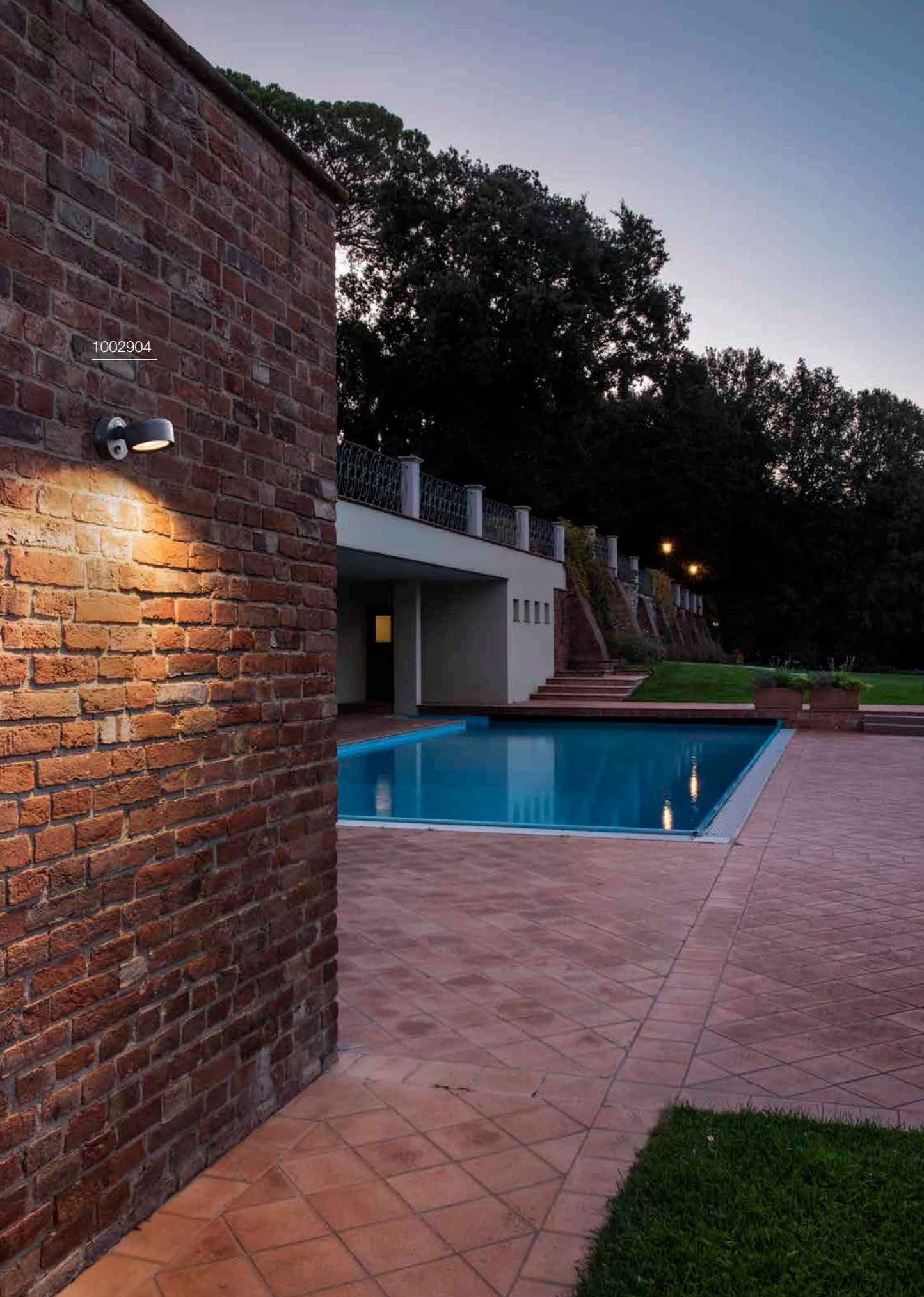



ESKINA SPOT SENSOR CW, PHASE

ESKINA SPOT CW, PHASE

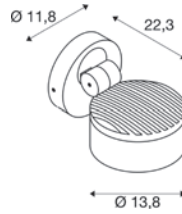

220-240 V ~50/60 Hz | 350 mA
Total wattage: 15 W
Material: aluminium

- Motion sensor in the wall rosette.
- PIR sensor, adjustable range 0-1000 lx and 8 s-12 min. Detection range up to 10 m depending on the mounting height of the light



1000 lm | 3000 K | 4000 K

Options	Prod. no.
● anthracite	1002904

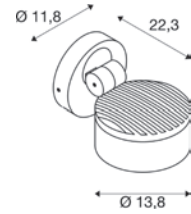

220-240 V ~50/60 Hz | 350 mA
Total wattage: 14.5 W
Material: aluminium



1000 lm | 3000 K | 4000 K

Options	Prod. no.
● anthracite	1002903

SITRA 360
CW, TCR-TSE

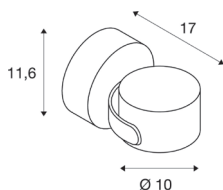

220-240 V ~50/60 Hz
Material: aluminium/glass



Base: 1xG53 max. Ø: 7.5 cm L: 3.5 cm

Options

- anthracite

Prod. no.

231515



GX53 | 6 W | 120°
490 lm | 2700 K | EEC = G
7 kW/1000h



Prod. no.: 1005272

THEO BRACKET
CW

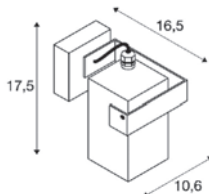

220-240 V ~50/60 Hz
Material: aluminium/glass



Base: 1xGU10 max. Ø: 5.1 cm L: 5.7 cm

Options

- anthracite

Prod. no.

1004653



GU10 | 6 W | 38°
450 lm | 2700 K | EEC = F
6 kW/1000h



Prod. no.: 1005077

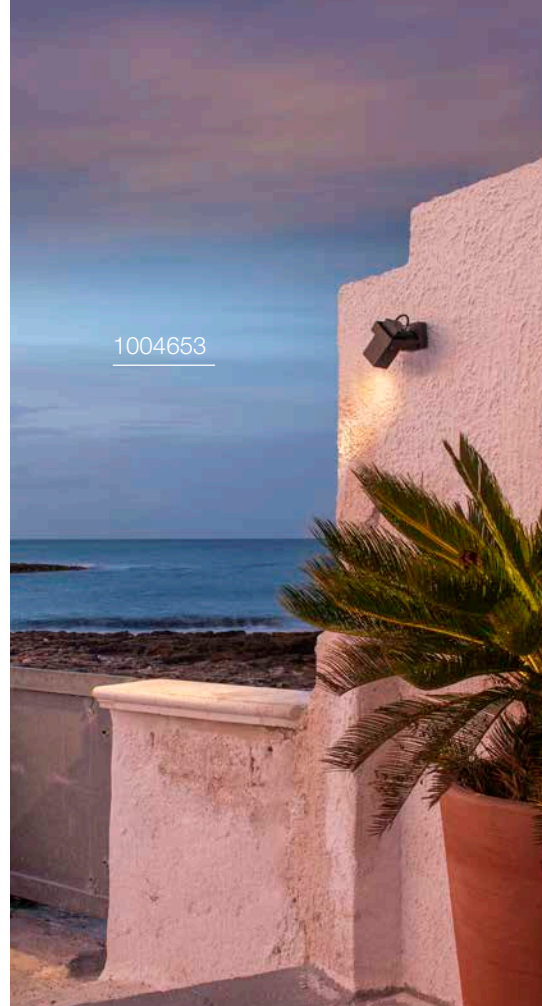



HELIA CW, single

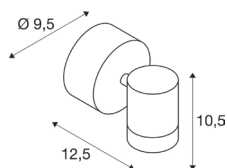

220-240 V ~50/60 Hz | 500 mA
Total wattage: 6.5 W
Material: aluminium/glass



440 lm | 3000 K

Options	Prod. no.
● anthracite	233245



Product	Prod. no.
Spacer	
● anthracite	1002853



HELIA CW, double

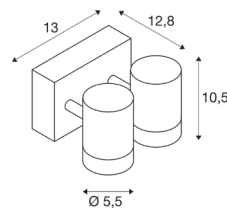

220-240 V ~50/60 Hz | 500 mA
Total wattage: 13 W
Material: aluminium/glass



Spot 1 440 lm | 3000 K
Spot 2 440 lm | 3000 K

Options	Prod. no.
● anthracite	233255



Product	Prod. no.
Spacer	
● anthracite	1002853





229971

AINOS CW

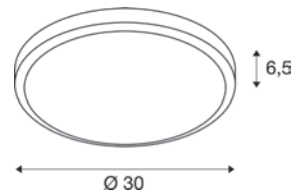

220-240 V ~50/60 Hz | 500 mA

Total wattage: 21 W

Material: aluminium/polycarbonate (PC)



1430lm|3000K

Options	Prod. no.
● anthracite	229965
○ white	229961



1003452



AINOS CW, SENSOR

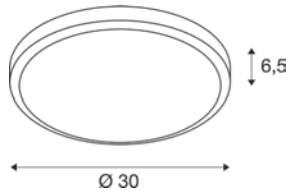

220-240 V ~50/60 Hz | 500 mA
Total wattage: 22 W
Material: aluminium/polycarbonate (PC)

- Sensor in the light housing



1430lm|3000K

Options	Prod. no.
● anthracite	229975
○ white	229971

AINOS CW, square

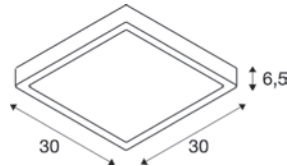

220-240 V ~50/60 Hz | 500 mA
Total wattage: 17 W
Material: aluminium/polycarbonate (PC)

- Sensor in the light housing



1300lm|3000K |4000K

Options	Prod. no.
● anthracite	1003450
○ white	1003449

AINOS CW, SENSOR, square

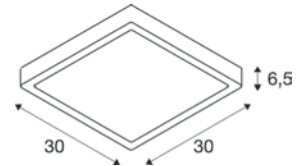

220-240 V ~50/60 Hz | 500 mA
Total wattage: 18 W
Material: aluminium/polycarbonate (PC)

- Sensor in the light housing



1300lm|3000K |4000K

Options	Prod. no.
● anthracite	1003452
○ white	1003451

RUBA
CW

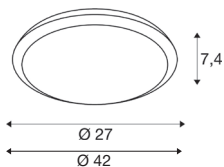

220-240 V ~50/60 Hz | 300 mA

Total wattage: 12 W

Material: polycarbonate (PC)



960 lm	3000 K	1100 lm	4000 K
2000 lm		2300 lm	

Options

Prod. no.

- white | Ø: 27 cm

1005089

- white | Ø: 42 cm

1005090

TERANG 200
CW

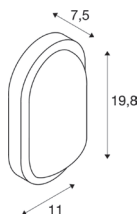

220-240 V ~50/60 Hz

Total wattage: 11 W

Material: aluminium/polycarbonate (PC)



830 lm | 3000 K

Options

Prod. no.

- anthracite

229935

- white

229931

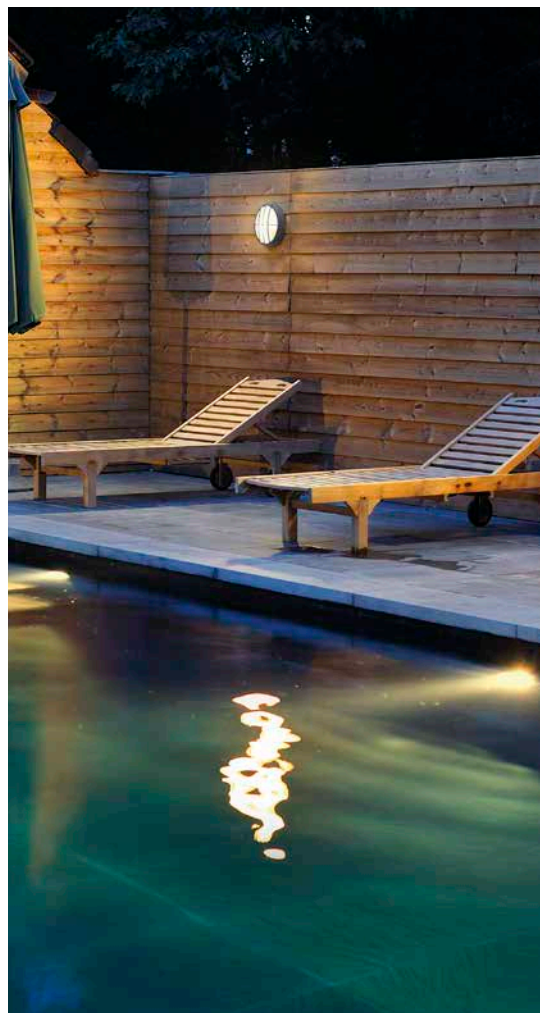



BULAN CW, E14

BULAN GRID CW, E27

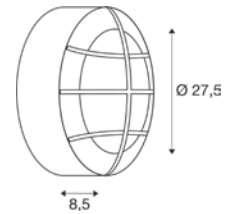
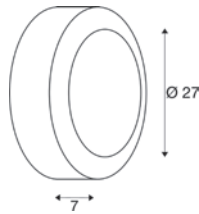

220-240 V ~50/60 Hz
Material: aluminium/glass



220-240 V ~50/60 Hz
Material: aluminium/polycarbonate (PC)



Base: 1xE14 max. Ø: 4.8 cm | L: 13 cm

Base: 2xE27 max. Ø: 5.2 cm | L: 17.3 cm

Options	Prod. no.
● anthracite	229075
○ white	229071
● grey	229072

Options	Prod. no.
● anthracite	229085
○ white	229081



E14 | 4 W | 320°
350 lm | 2700 K | EEC = G
5 kW/1000h



Prod. no.: 1005285



E27 | 8 W | 240°
880 lm | 3000 K | EEC = E
8 kW/1000h



Prod. no.: 1005289



229085

233605

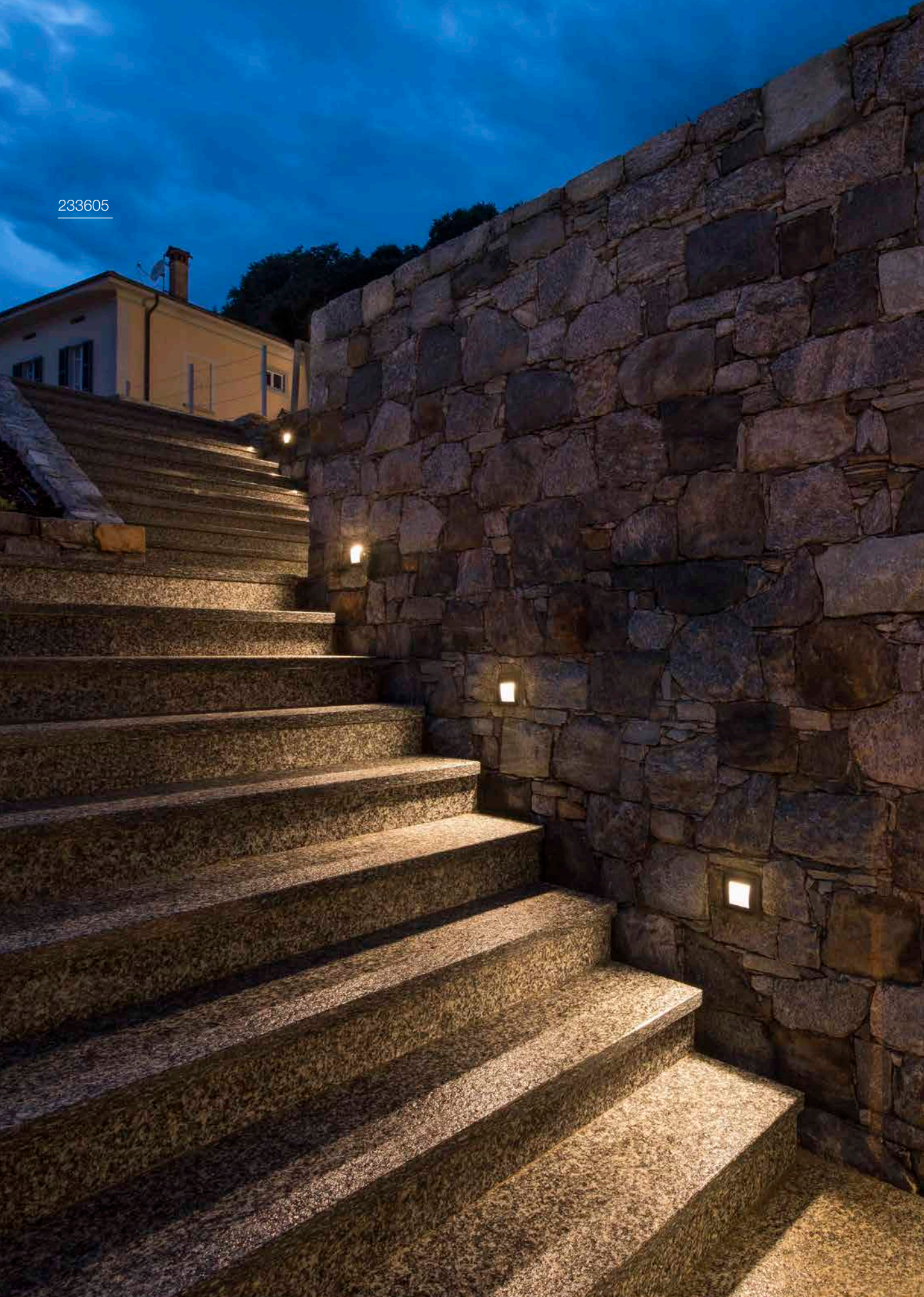



LED

CONCRETO | 267



LED

ADI | 268



LED

DOWNUNDER OUT | 269



LED

BRICK MESH | 271



LED

BRICK | 271



LED

SOCKET
BRICK DOWNUNDER |
273

1006406



1006407

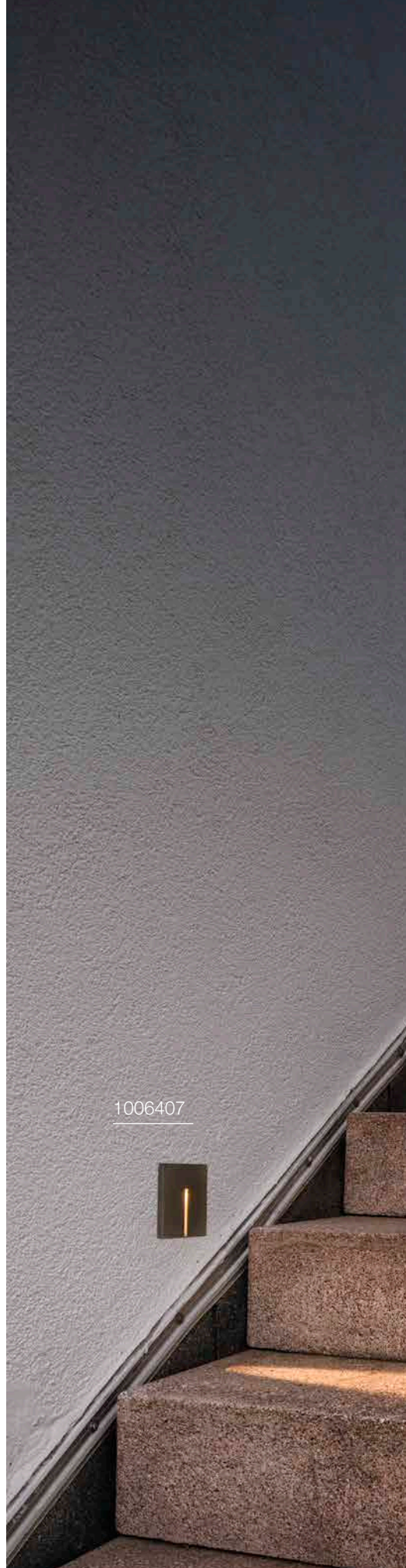



CONCRETO EL, Wing

CONCRETO EL, Cut

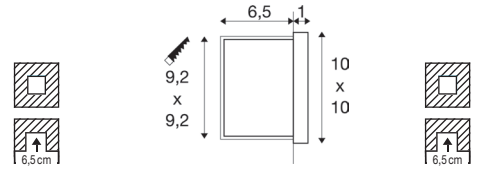
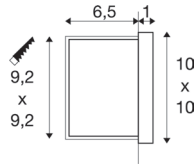

100-240 V ~50/60 Hz | 700 mA
Total wattage: 3.2 W
Material: concrete/aluminium

100-240 V ~50/60 Hz | 700 mA
Total wattage: 3.2 W
Material: concrete/aluminium

- Recessed fixing kit included

- Recessed fixing kit included



45 lm | 3000 K

15 lm | 3000 K

Options	Prod. no.
● grey/black	1006406

Options	Prod. no.
● grey/black	1006407

ADI
EL

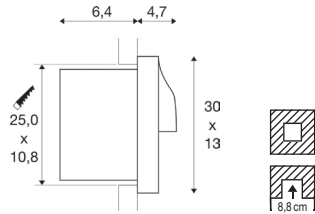

100-277 V ~50/60 Hz | 500 mA
Total wattage: 18 W
Material: aluminium/polycarbonate (PC)

- Only mount the light with the light beam pointing downwards
- Recessed fixing kit must be ordered separately



940lm | 3000 K

Options	Prod. no.
● anthracite	233635



Product	Prod. no.
Recessed fixing kit	
● black	233639





DOWNUNDER OUT S EL

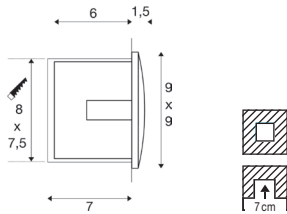

220-240 V ~50/60 Hz | 300 mA
Total wattage: 1.7 W
Material: aluminium/plastic

- Only mount the light with the light beam pointing downwards
- Recessed fixing kit included



Down 25 lm|3000 K 65 lm|3000 K

Options	Prod. no.
● anthracite 25 lm	233605
○ white 65 lm	233601

DOWNUNDER OUT M EL

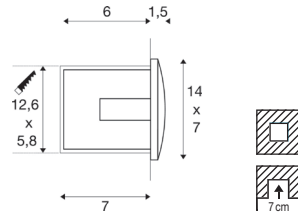

220-240 V ~50/60 Hz | 300 mA
Total wattage: 4 W
Material: aluminium/plastic

- Only mount the light with the light beam pointing downwards
- Recessed fixing kit included



Down 85 lm|3000 K 155 lm|3000 K

Options	Prod. no.
● anthracite 85 lm	233625
○ white 155 lm	233621

DOWNUNDER OUT L EL

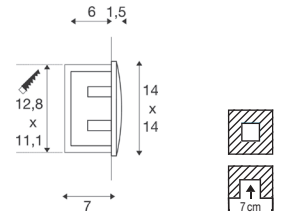

220-240 V ~50/60 Hz | 300 mA
Total wattage: 4 W
Material: aluminium/plastic

- Only mount the light with the light beam pointing downwards
- Recessed fixing kit included



Down 85 lm|3000 K

Options	Prod. no.
● anthracite	233615



233660



233650



BRICK MESH EL

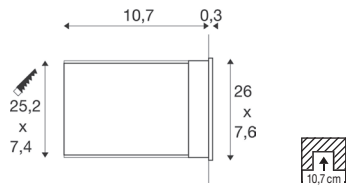

220-240 V ~50/60 Hz | 500 mA
Total wattage: 5 W
Material: stainless steel 304

- Light does not need to be opened from the front for connection
- Recessed fixing kit with break-out openings of different sizes
- Recessed fixing kit included



Down 150 lm | 3000 K

Options	Prod. no.
● stainless steel	1008481

BRICK EL, symmetrical

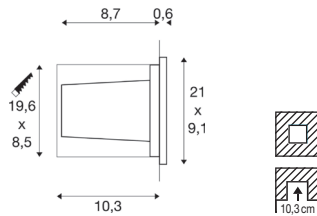

220-240 V ~50/60 Hz | 144 mA
Total wattage: 9.5 W
Material: aluminium/stainless steel 316

- Recessed fixing kit included



Down 950 lm | 3000 K

Options	Prod. no.
● stainless steel	233650

BRICK EL, asymmetrical

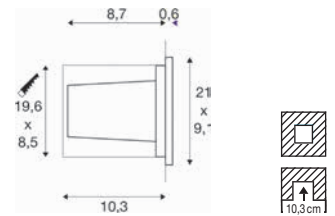

220-240 V ~50/60 Hz | 144 mA
Total wattage: 9.5 W
Material: aluminium/stainless steel 316

- Recessed fixing kit included



Down 850 lm | 3000 K

Options	Prod. no.
● stainless steel	233660





BRICK DOWNUNDER EL, E14

BRICK DOWNUNDER EL

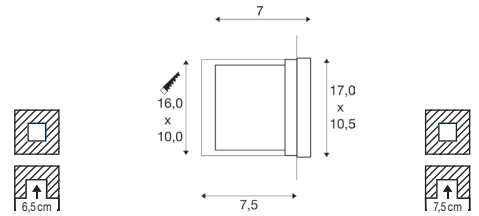
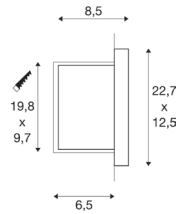

220-240 V ~50/60 Hz
Material: aluminium/glass

- No recessed fixing kit required



Base: 1xE14 max. Ø: 4.3 cm | L: 12 cm

Options	Prod. no.
● grey	229062



220-240 V ~50/60 Hz
Total wattage: 1.4 W
Material: aluminium/glass

- Recessed fixing kit included



30lm|3000K

Options	Prod. no.
● grey	229702



E14 | 4 W | 320°
380lm | 2700K | EEC = F
5 kW/1000h

Prod. no.: 1005284



229062



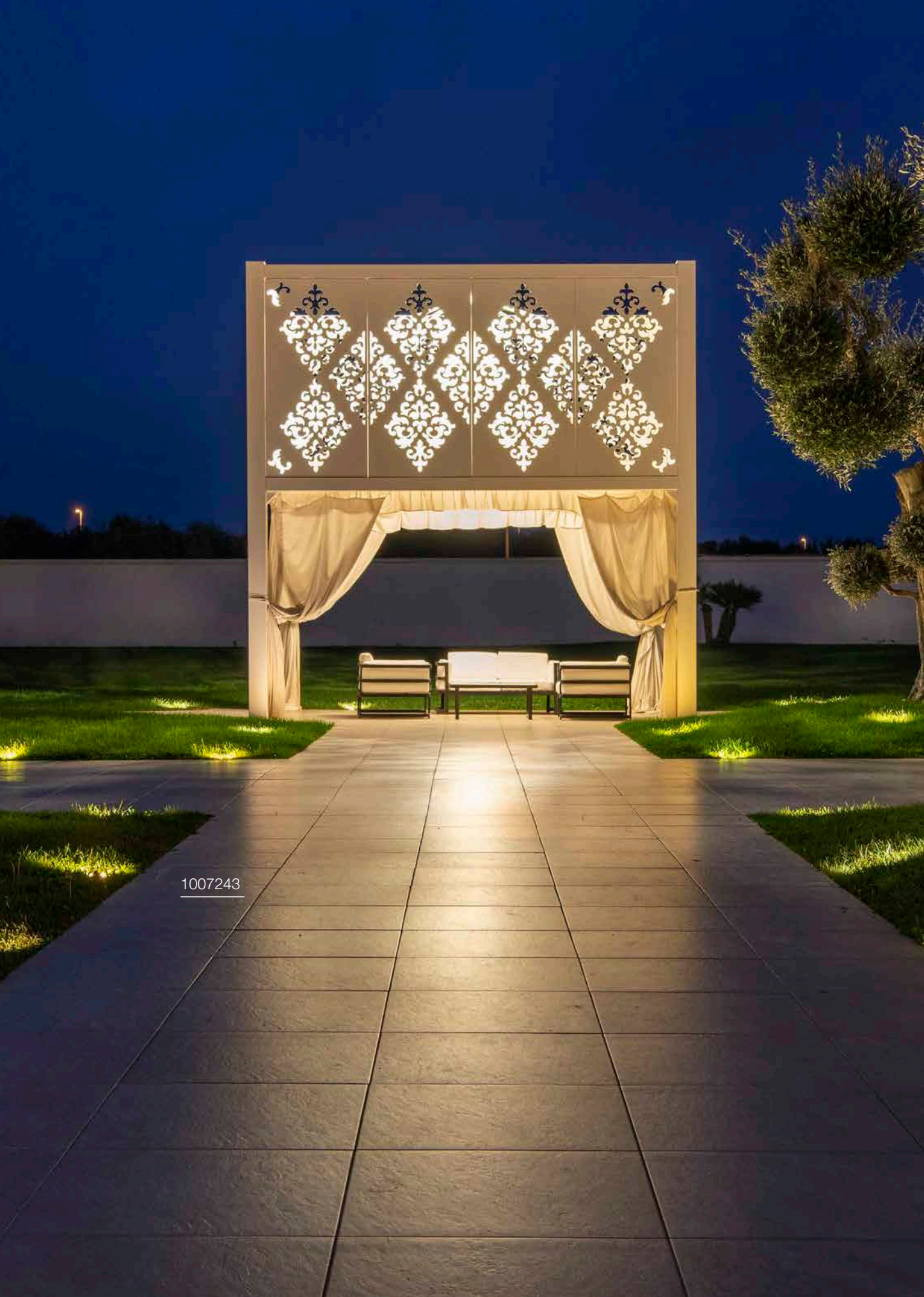

1007243



LED
DASAR® | 277



LED
DASAR® | 279-289



NEW



LED
DASAR® FLAT | 291



LED
DASAR® 255 | 291



LED
DASAR® 920 | 293



SOCKET
DASAR® 115 | 295



SOCKET
DASAR® EXACT 116 | 297



SOCKET



SOCKET
DASAR® 215 | 299



SOCKET
DASAR® 215 | 299



LED
DASAR® 370 | 299



LED
TRAIL-LITE® 60 | 301



NEW



LED
POWER TRAIL-LITE® | 303



LED
SMALL PLOT | 305



LED
BIG PLOT | 307



LED
ROCCI | 309



LED
ROCCI 200 | 311



LED
SOLASTO | 313





1007196



DASAR® 600 EL

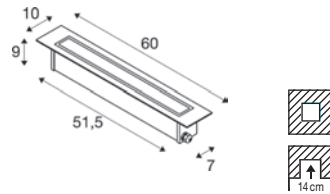

220-240 V ~50/60 Hz | 550 mA
Total wattage: 18 W
Material: stainless steel 316

- marked installation direction
- Recessed fixing kit incl. cover can be ordered separately
- IP connection box



2200lm|3000 K

Options	Prod. no.
● stainless steel	1007195



Product	Prod. no.
Recessed fixing kit	
● black	1007198

DASAR® 1200 EL

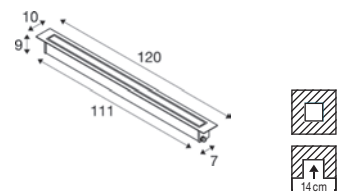

220-240 V ~50/60 Hz | 900 mA
Total wattage: 34 W
Material: stainless steel 316

- marked installation direction
- Recessed fixing kit incl. cover can be ordered separately
- IP connection box



4100lm|3000 K

Options	Prod. no.
● stainless steel	1007196



Product	Prod. no.
Recessed fixing kit	
● black	1007197



1007680



DASAR® S RL, round

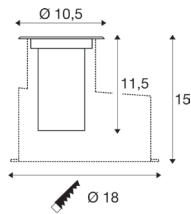

220-240 V ~50/60 Hz | 200 mA
Total wattage: 4 W
Material: aluminium

- Conveniently adjustable light distribution using 15°, 36° and 50° interchangeable optics
- Recessed fixing kit incl. cover can be ordered separately
- IP connection box



350lm|3000 K

Options	Prod. no.
● stainless steel	1007680



Product	Prod. no.
Recessed floor fixing kit S	
● black	1007682
○ silver	1007683
Reflector 15°	
○ silver	1007684
Reflector 36°	
○ silver	1007685

DASAR® S RL, square

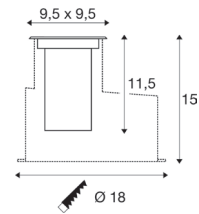

220-240 V ~50/60 Hz | 200 mA
Total wattage: 4 W
Material: aluminium

- Conveniently adjustable light distribution using 15°, 36° and 50° interchangeable optics
- Recessed fixing kit incl. cover can be ordered separately
- IP connection box



350lm|3000 K

Options	Prod. no.
● stainless steel	1007681



Product	Prod. no.
Recessed floor fixing kit S	
● black	1007682
○ silver	1007683
Reflector 15°	
○ silver	1007684
Reflector 36°	
○ silver	1007685

DASAR® M

RL, round

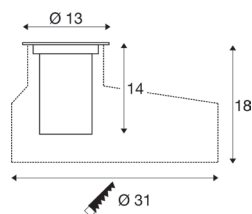

220-240 V ~50/60 Hz | 300 mA
 Total wattage: 6.5 W
 Material: aluminium

- Conveniently adjustable light distribution using 15°, 36° and 50° interchangeable optics
- Recessed fixing kit incl. cover can be ordered separately
- IP connection box



450lm | 3000 K

1007810

Options

Prod. no.

- stainless steel

1007810



Product

Prod. no.

Reflector 15°

- silver

1007683

Reflector 36°

- silver

1007684

Reflector 50°

- silver

1007685

Recessed floor fixing kit M

- black

1007822

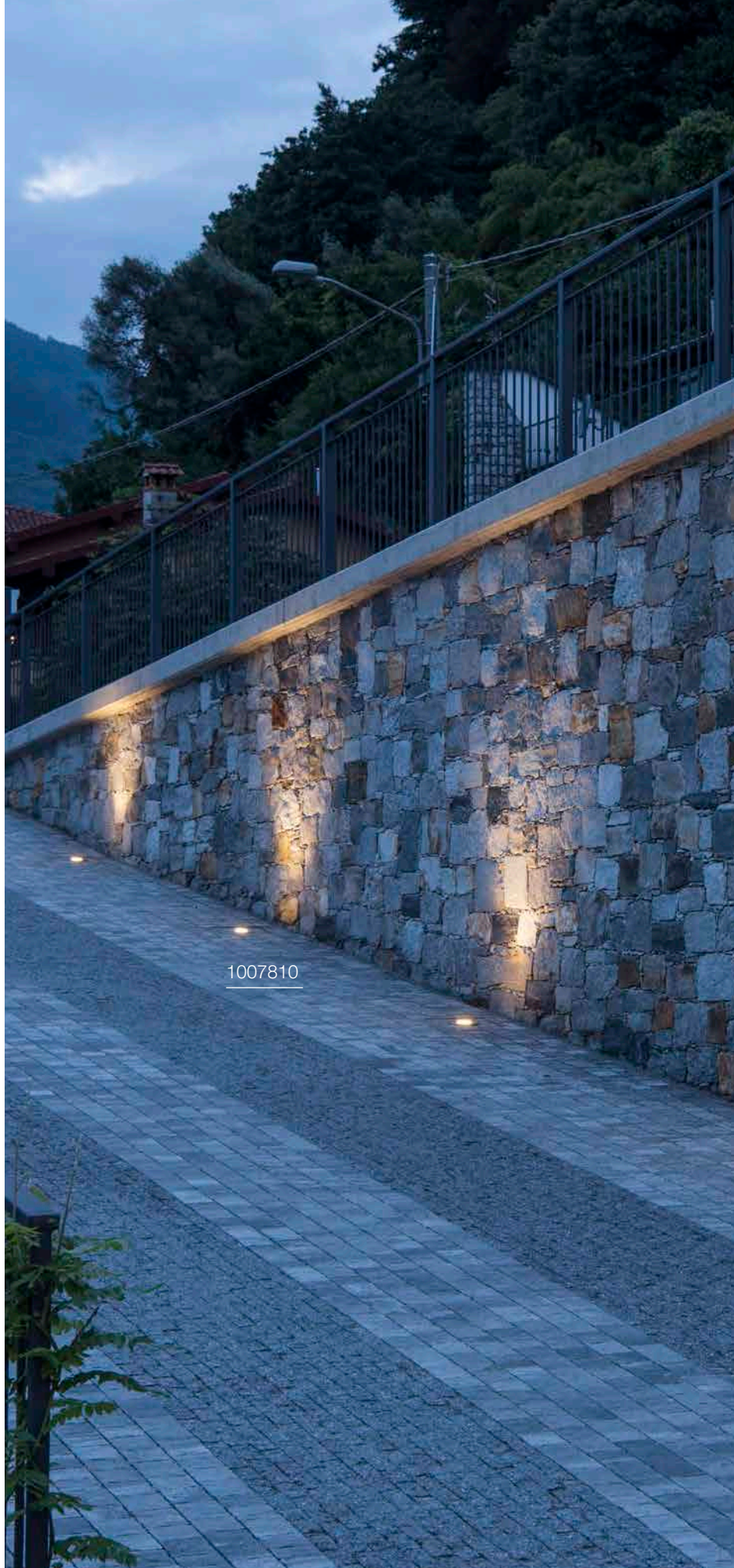



DASAR® M

RL, square

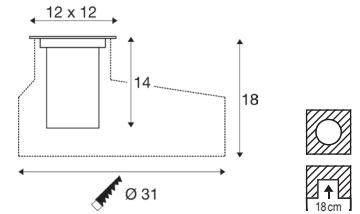

220-240 V ~50/60 Hz | 300 mA
 Total wattage: 6.5 W
 Material: aluminium

- Conveniently adjustable light distribution using 15°, 36° and 50° interchangeable optics
- Recessed fixing kit incl. cover can be ordered separately
- IP connection box



450lm|3000 K

Options	Prod. no.
● stainless steel	1007811



Product	Prod. no.
Reflector 15°	
○ silver	1007683
Reflector 36°	
○ silver	1007684
Reflector 50°	
○ silver	1007685
Recessed floor fixing kit M	
● black	1007822



1007243



1007244



DASAR® L RL, round

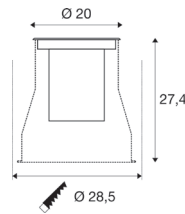

220-240 V ~50/60 Hz | 500 mA
Total wattage: 19 W
Material: aluminium

- Recessed fixing kit incl. cover can be ordered separately
- Conveniently adjustable light distribution using 15°, 36° and 60° interchangeable optics
- IP connection box



1950lm|3000 K

Options	Prod. no.
● stainless steel	1007243



Product	Prod. no.
Reflector 15° for L / XL	
○ silver	1007238
Reflector 36° for L / XL	
○ silver	1007239
Reflector 60° for L / XL	
○ silver	1007240
Recessed fixing kit for DASAR L	
● black	1007245

DASAR® L RL, square

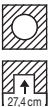
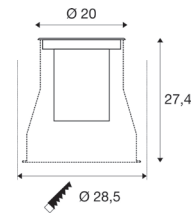

220-240 V ~50/60 Hz | 500 mA
Total wattage: 19 W
Material: aluminium

- Recessed fixing kit incl. cover can be ordered separately
- Conveniently adjustable light distribution using 15°, 36° and 60° interchangeable optics
- IP connection box



1950lm|3000 K

Options	Prod. no.
● stainless steel	1007244



Product	Prod. no.
Reflector 15° for L / XL	
○ silver	1007238
Reflector 36° for L / XL	
○ silver	1007239
Reflector 60° for L / XL	
○ silver	1007240
Recessed fixing kit for DASAR L	
● black	1007245



1009169



DASAR® L

RL, asym, round, DALI

DASAR® L

RL, asym, square, DALI

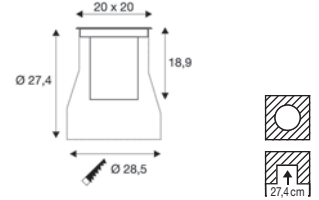
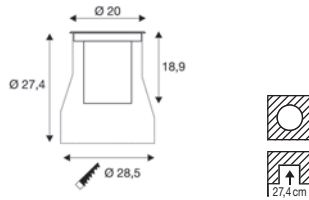

220-240 V ~50/60 Hz | 500 mA
 Total wattage: 19 W
 Material: stainless steel 316/glass/aluminium

220-240 V ~50/60 Hz | 500 mA
 Total wattage: 19 W
 Material: stainless steel 316/glass/aluminium

- IP connection box
- Recessed fixing kit incl. cover can be ordered separately

- IP connection box
- Recessed fixing kit incl. cover can be ordered separately



Asymetrical 1800lm|3000 K



Asymetrical 1800lm|3000 K

Options	Prod. no.
● stainless steel/black	1009168 ●

Options	Prod. no.
● stainless steel/black	1009169 ●



Product	Prod. no.
Recessed fixing kit for DASAR L	
● black	1007245



Product	Prod. no.
Recessed fixing kit for DASAR L	
● black	1007245

DASAR® XL

RL, round

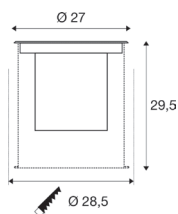

220-240 V ~50/60 Hz | 700 mA
 Total wattage: 27 W
 Material: aluminium

- Recessed fixing kit incl. cover can be ordered separately
- Conveniently adjustable light distribution using 15°, 36° and 60° interchangeable optics
- IP connection box



2790lm|3000 K

Options

Prod. no.

- stainless steel

1007241



Product

Prod. no.

Reflector 15° for L / XL

- silver **1007238**

Reflector 36° for L / XL

- silver **1007239**

Reflector 60° for L / XL

- silver **1007240**

Recessed fixing kit for DASAR XL

- black **1007246**





DASAR® XL

RL, square

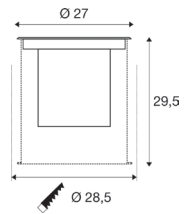

220-240 V ~50/60 Hz | 700 mA

Total wattage: 27 W

Material: aluminium

- Recessed fixing kit incl. cover can be ordered separately
- Conveniently adjustable light distribution using 15°, 36° and 60° interchangeable optics
- IP connection box



2790lm|3000K

Options	Prod. no.
● stainless steel	1007242



Product	Prod. no.
Reflector 15° for L / XL	
○ silver	1007238
Reflector 36° for L / XL	
○ silver	1007239
Reflector 60° for L / XL	
○ silver	1007240
Recessed fixing kit for DASAR XL	
● black	1007246

1007242



1009170



DASAR® XL, RL, asym, round, DALI

DASAR® XL, RL, asym, square, DALI

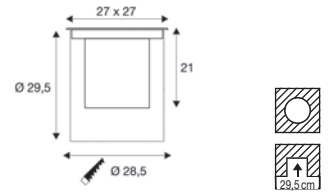
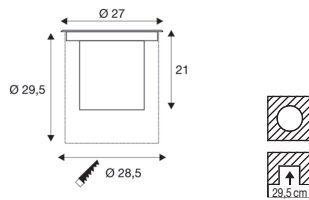

220-240 V ~50/60 Hz | 700 mA
 Total wattage: 27 W
 Material: stainless steel 316/glass/aluminium

220-240 V ~50/60 Hz | 700 mA
 Total wattage: 27 W
 Material: stainless steel 316/glass/aluminium

- IP connection box
- Recessed fixing kit incl. cover can be ordered separately

- IP connection box
- Recessed fixing kit incl. cover can be ordered separately



Asymmetrical 2600lm|3000 K



Asymmetrical 2600lm|3000 K

Options	Prod. no.
● stainless steel/black	1009170 ●

Options	Prod. no.
● stainless steel/black	1009171 ●



Product	Prod. no.
Recessed fixing kit for DASAR XL	
● black	1007246



Product	Prod. no.
Recessed fixing kit for DASAR XL	
● black	1007246



228412



229383



DASAR® FLAT 80 EL

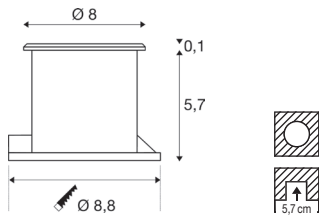

220-240 V ~50/60 Hz
Total wattage: 3.5 W
Material: stainless steel 304/glass

- Recessed fixing kit included
- This light is suitable for installation in wood
- open cable end



Up 140lm|3000 K

Options	Prod. no.
● stainless steel	228412

DASAR® FLAT 120 EL

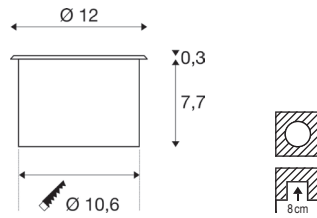

220-240 V ~50/60 Hz | 350 mA
Total wattage: 7 W
Material: stainless steel 304/aluminium

- Recessed fixing kit included
- open cable end



490lm|3000 K

Options	Prod. no.
● stainless steel	1006106

DASAR® 255 EL

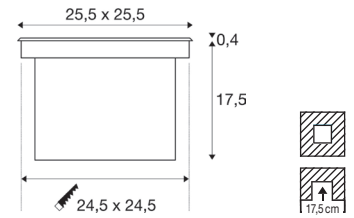

220-240 V ~50/60 Hz | 750 mA
Total wattage: 31 W
Material: stainless steel 316/glass

- Recessed fixing kit included



1660lm|3000 K
1720lm|4000 K

Options	Prod. no.
● stainless steel 1720 lm 4000 K	229381
● stainless steel 1660 lm 3000 K	229383



Product	Prod. no.
Connection box IP68, 3-pole	
● black	228730



233500



DASAR® 920 EL

DASAR® 920 EL

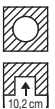
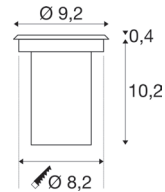
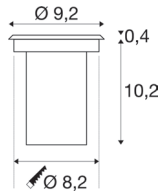

12-24 V
Total wattage: 6.5 W
Material: stainless steel 316/glass

220-240 V ~50/60 Hz | 400 mA
Total wattage: 5.5 W
Material: stainless steel 316/glass

- Recessed fixing kit included
- open cable end

- Recessed fixing kit included
- open cable end



520lm|3000 K

300lm|3000 K

Options	Prod. no.
● stainless steel	233500

Options	Prod. no.
● stainless steel	233520



Product	Prod. no.
LED power supply, 15W 12V	
○ white	1005444
LED power supply, 15 W 24V	
○ white	1005445



229320



DASAR® 115
RL, round, QPAR51

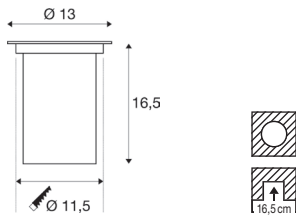

220-240 V ~50/60 Hz
Material: stainless steel 316/glass

- Recessed fixing kit included



Base: 1xGU10 max. Ø: 5.1 cm | L: 6 cm

Options	Prod. no.
● stainless steel	229320



GU10 | 2 W | 36°
230 lm | 2700 K | EEC = E
3 kW/1000h

Prod. no.: 1007230

DASAR® 115
RL, square, QPAR51

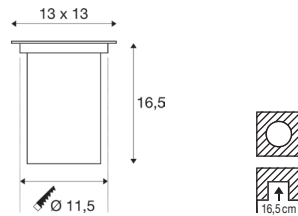

220-240 V ~50/60 Hz
Material: stainless steel 316/glass

- Recessed fixing kit included



Base: 1xGU10 max. Ø: 5.1 cm | L: 6 cm

Options	Prod. no.
● stainless steel	229324



GU10 | 2 W | 36°
230 lm | 2700 K | EEC = E
3 kW/1000h

Prod. no.: 1007230

DASAR® 115
RL, square, QPAR51

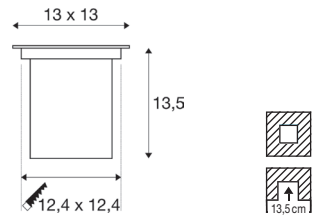

220-240 V ~50/60 Hz
Material: stainless steel 316/glass

- Recessed fixing kit included



Base: 1xGU10 max. Ø: 5.1 cm | L: 6 cm

Options	Prod. no.
● stainless steel	229374



GU10 | 2 W | 36°
230 lm | 2700 K | EEC = E
3 kW/1000h

Prod. no.: 1007230



228430



DASAR® EXACT 116
EL, round, QPAR51

DASAR® EXACT 116
EL, square, QPAR51

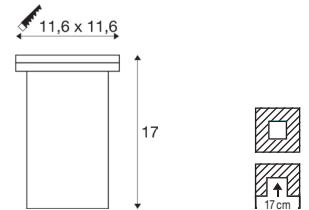
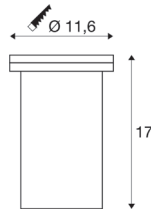

220-240 V ~50/60 Hz
Material: stainless steel 316/glass

220-240 V ~50/60 Hz
Material: stainless steel 316/glass

- Recessed fixing kit included

- Recessed fixing kit included



Base: 1xGU10 max. Ø: 5.1 cm | L: 6 cm

Base: 1xGU10 max. Ø: 5.1 cm | L: 6 cm

Options	Prod. no.
● stainless steel	228430

Options	Prod. no.
● stainless steel	228434



GU10 | 2W | 36°
230 lm | 2700K | EEC = E
3 kW/1000h

Prod. no.: **1007230**



GU10 | 2W | 36°
230 lm | 2700K | EEC = E
3 kW/1000h

Prod. no.: **1007230**



229230



DASAR® 215
RL, round, QPAR111

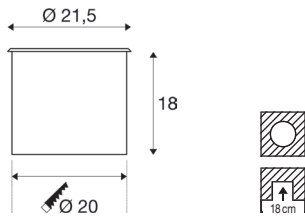

220-240 V ~50/60 Hz
Material: stainless steel 316/glass

- Recessed fixing kit included

DASAR® 215
RL, square, QPAR111

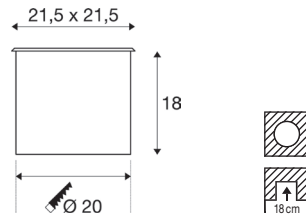

220-240 V ~50/60 Hz
Material: stainless steel 316/glass

- Recessed fixing kit included

DASAR® 370
EL, round

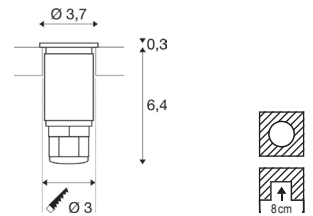

12-24 V
Power consumption: 2W
Material: stainless steel 316/glass

- This light is suitable for installation in wood
- open cable end



Base: 1xGU10

Options	Prod. no.
● stainless steel	229230



GU10 | 13 W | 12°
650 lm | 3000 K | EEC = F
13 kW/1000h



Prod. no.: **1005278**



Base: 1xGU10

Options	Prod. no.
● stainless steel	229234



GU10 | 13 W | 12°
650 lm | 3000 K | EEC = F
13 kW/1000h



Prod. no.: **1005278**



120lm|3000K

Options	Prod. no.
● stainless steel	233540



Product	Prod. no.
LED power supply, 15W 12V	
○ white	1005444
LED power supply, 15 W 24V	
○ white	1005445



227462



TRAIL-LITE® 60 EL

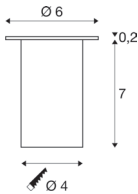

12 V 50/60 Hz
Power consumption: 0.3W
Material: stainless steel 316/glass

- Only operate with conventional transformer
- Recessed fixing kit included
- This light is suitable for installation in wood



4 lm | 3000 K

Options	Prod. no.
● stainless steel	227462

TRAIL-LITE® 60 EL

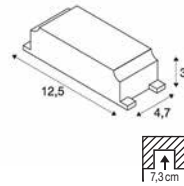
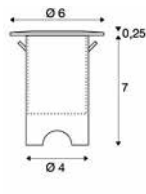

220-240 V ~50/60 Hz | 24 V
Total wattage: 4.6 W
Material: stainless steel 316/aluminium

- Set consisting of 4 lights, connector, cable and plug-in power supply unit
- This light is suitable for installation in wood
- IP44 safety plug



25 lm | 3000 K

Options	Prod. no.
● stainless steel/ aluminium	1008841 ●

TRAIL-LITE® 60 EL, single

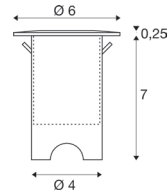

24 V
Power consumption: 0.9 W
Material: stainless steel 316/aluminium

- Recessed fixing kit included
- This light is suitable for installation in wood
- Low-voltage secondary connection female



Up 25 lm | 3000 K

Options	Prod. no.
● stainless steel/ aluminium	1008842 ●



Product	Prod. no.
LED power supply 12.6 W	
● black	1008843 ●



228332



POWER TRAIL-LITE® EL, square

POWER TRAIL-LITE® EL, round

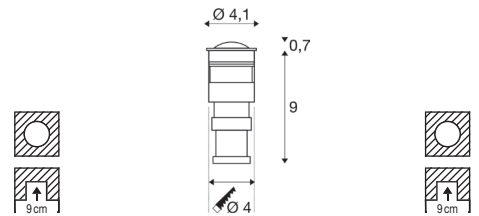
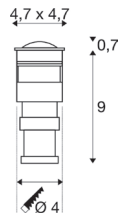

350 mA
Power consumption: 1W
Material: stainless steel 316/glass

350 mA
Power consumption: 1W
Material: stainless steel 316/glass

- Operate only with 350mA driver. Only wire together multiple power LEDs in series! Installation sleeve incl.
- This light is suitable for installation in wood
- open cable end

- Operate only with 350mA driver. Only wire together multiple power LEDs in series!
- This light is suitable for installation in wood
- open cable end



45 lm | 3000 K



45 lm | 3000 K

Options	Prod. no.
● stainless steel	228342

Options	Prod. no.
● stainless steel	228332



Product	Prod. no.
LED driver 3W 350W	
○ white	1005248



1006171+1006173



SMALL PLOT Modules

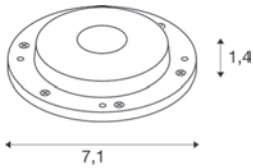

24 V
Power consumption: 2.6W
Material: aluminium/polymethylmethacrylate (PMMA)

- This product is delivered without a cover
- open cable end



240lm|3000 K

Options	Prod. no.
● aluminium	1006172



Product	Prod. no.
LED power supply, 12/20W 24V incl. strain relief	
○ white	1005381
LED power supply, 15 W 24V	
○ white	1005445

SMALL PLOT Modules

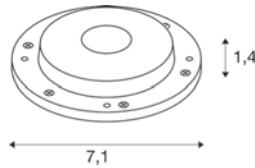

24 V
Power consumption: 2.6W
Material: stainless steel/polymethylacrylate (PMMA)

- This product is delivered without a cover
- open cable end



240lm|3000 K

Options	Prod. no.
● stainless steel	1006171



Product	Prod. no.
LED power supply, 12/20W 24V incl. strain relief	
○ white	1005381
LED power supply, 15 W 24V	
○ white	1005445

SMALL PLOT Cover, 2-pack



Ø: 10.3 cm
H: 1.7 cm
Material: stainless steel

Options	Prod. no.
● anthracite	1006174
● stainless steel	1006173

SMALL PLOT Cover, 4-pack



Ø: 10.3 cm
H: 1.7 cm
Material: stainless steel

Options	Prod. no.
● anthracite	1006176
● stainless steel	1006175



1008001+1001255



BIG PLOT Modules

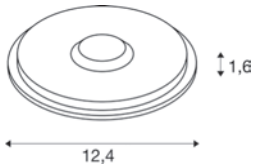

220-240 V ~50/60 Hz
 Total wattage: 4.9 W
 Material: aluminium/polymethylmethacrylate (PMMA)

- This product is delivered without a cover
- open cable end



540 lm | 3000 K

Options	Prod. no.
● aluminium	1008000



Product	Prod. no.
T-connector box	
● black	228726
Connection box IP68, 3-pole	
● black	228730
Aluminium cover two light emissions	
● anthracite	1001262
Aluminium cover four light emissions	
● anthracite	1001263

BIG PLOT Modules

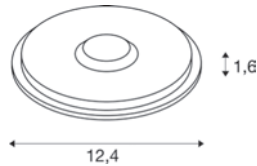

220-240 V ~50/60 Hz
 Total wattage: 4.9 W
 Material: stainless steel/polymethylacrylate (PMMA)

- This product is delivered without a cover
- open cable end



540 lm | 3000 K

Options	Prod. no.
● stainless steel	1008001



Product	Prod. no.
T-connector box	
● black	228726
Connection box IP68, 3-pole	
● black	228730
SST316L cover two light emissions	
● stainless steel	1001254
SST316L cover four light emissions	
● stainless steel	1001255

BIG PLOT Cover, 2-pack



Ø: 17 cm
 H: 2 cm
 Material: stainless steel 316

- 1001262 loadable up to 0.5 t
- 1001254 loadable up to 0.8 t

Options	Prod. no.
● anthracite	1001262
● stainless steel	1001254

BIG PLOT Cover, 4-pack



Ø: 17 cm
 H: 2 cm
 Material: stainless steel 316

- 1001255 loadable up to 0.8 t
- 1001263 loadable up to 0.8 t

Options	Prod. no.
● anthracite	1001263
● stainless steel	1001255



227604



ROCCI
EL, square

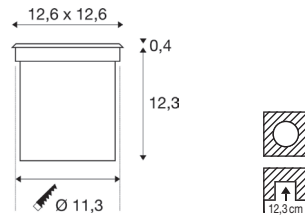

100-277 V ~50/60 Hz | 700 mA
Total wattage: 8.6 W
Material: stainless steel 316/glass

- Recessed fixing kit included



580lm|3000K

Options	Prod. no.
● stainless steel	227604

ROCCI
EL, round

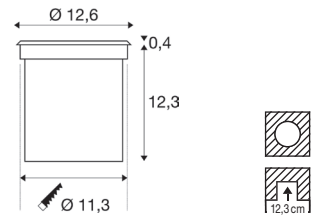

100-277 V ~50/60 Hz | 700 mA
Total wattage: 8.6 W
Material: stainless steel 316/glass

- Recessed fixing kit included



580lm|3000K

Options	Prod. no.
● stainless steel	227600



1006105



ROCCI 200 EL, square

ROCCI 200 EL, round

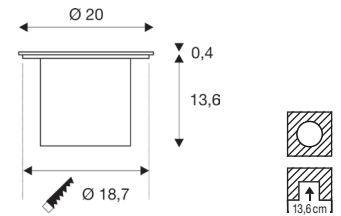
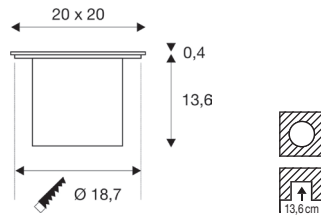

100-277 V ~50/60 Hz | 350 mA
Total wattage: 16 W
Material: stainless steel 316/glass

100-277 V ~50/60 Hz | 350 mA
Total wattage: 16 W
Material: stainless steel 316/glass

- Recessed fixing kit included

- Recessed fixing kit included



1530lm|3000K

1530lm|3000K

Options	Prod. no.
● stainless steel	1006105

Options	Prod. no.
● stainless steel	1006104



227680



SOLASTO EL, round

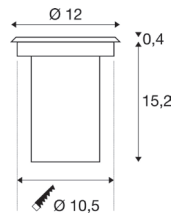

220-240 V ~50/60 Hz
Material: stainless steel 304/glass

- Recessed fixing kit included



Base: 1xGU10

Options	Prod. no.
● stainless steel	227680



GU10 | 6W | 38°
470 lm | 3000K | EEC = F
6 kW/1000h

Prod. no.: 1005079



SOLASTO EL, square

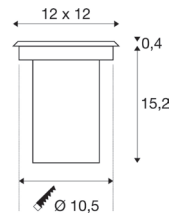

220-240 V ~50/60 Hz
Material: stainless steel 304/glass

- Recessed fixing kit included



Base: 1xGU10

Options	Prod. no.
● stainless steel	227684



GU10 | 6W | 38°
470 lm | 3000K | EEC = F
6 kW/1000h

Prod. no.: 1005079







LED QT14 | 316



LED C35 | 316-317



LED QT-DE12 | 316



LED G45 GOLD | 316



LED C35 GOLD | 316



LED TCR-TSE | 317



LED QR51 | 317



LED A60 | 317, 320, 323



LED T32 | 318



LED QPAR51 | 318



LED QPAR111 | 319



LED A19 | 319



LED GLOBE 150 | 320-321



LED GLOBE 125 | 320-321, 323



LED GLOBE 200 | 321



LED GLOBE 300 | 321



LED T32 | 322



LED T38 | 322



LED T45 | 322



LED ST64 | 322-323



LED ST65 | 323



LED ST58 | 323



SLVconnect® LED A60 SMART | 324



SLVconnect® LED QPAR111 SMART | 324



SLVconnect® LED ST19 SMART | 324



SLVconnect® LED QPAR51 SMART | 325

NEW

NEW

NEW

NEW

LED QT14 G9



220-240 V ~50/60 Hz
Material: glass
Ø: 3.2 cm L: 10 cm

Colour rendering	90
Output	3.6 W
Energy consumption/1000h	4 kWh

Options	Prod. no.
<input type="radio"/> transparent 400 lm 3000 K	1005286
<input type="radio"/> transparent 450 lm 2700 K	1007455

LED C35 G9



220-240 V ~50/60 Hz
Material: glass
Ø: 3.5 cm L: 9.5 cm

Manufacturer	Segula
Luminous flux	260 lm
Colour rendering	90
Output	3 W
Energy consumption/1000h	3 kWh

Options	Prod. no.
<input type="radio"/> transparent 2200 K	1008158

LED QT-DE12 R7S, 78 mm



220-240 V ~50/60 Hz
Material: polycarbonate (PC)
Ø: 2.9 cm | L: 2.9 cm

Luminous flux	1050 lm
Colour rendering	90
Output	9 W
Energy consumption/1000h	9 kWh

Options	Prod. no.
<input type="radio"/> transparent 3000 K	1005287

LED QT-DE12 R7S, 118 mm



220-240 V ~50/60 Hz
Material: polycarbonate (PC)
Ø: 2.9 cm L: 11.8 cm

Luminous flux	2000 lm
Colour rendering	90
Output	15 W
Energy consumption/1000h	15 kWh

Options	Prod. no.
<input type="radio"/> transparent 3000 K	1005288

LED G45 gold E14



220-240 V ~50/60 Hz
Material: glass
Ø: 4.5 cm L: 7.5 cm

Colour rendering	80
Output	2 W
Energy consumption/1000h	2 kWh

Options	Prod. no.
<input type="radio"/> gold/transparent 70 lm 1800K	1008649
<input type="radio"/> gold/transparent 75 lm 2200K	1008650

LED C35 gold E14



220-240 V ~50/60 Hz
Material: glass
Ø: 3.5 cm | L: 9.8 cm

Luminous flux	80 lm
Colour rendering	80
Output	2 W
Energy consumption/1000h	2 kWh

Options	Prod. no.
<input type="radio"/> gold/transparent 1800 K	1008647
<input type="radio"/> gold/transparent 2200 K	1008648

**LED C35**
E14

220-240 V ~50/60 Hz
Material: glass
Ø: 3.5 cm | L: 9.8 cm

Luminous flux	380 lm
Colour rendering	90
Output	4.2 W
Energy consumption/1000 h	5 kWh

Options **Prod. no.**

- transparent
2700 K **1005284**

LED C35
E14

220-240 V ~50/60 Hz
Material: glass
Ø: 3.5 cm | L: 9.8 cm

Luminous flux	350 lm
Colour rendering	90
Output	4.2 W
Energy consumption/1000 h	5 kWh

Options **Prod. no.**

- transparent
2700 K **1005285**

LED TCR-TSE
GX53

230 V 50/60 Hz
Material: polycarbonate (PC)
Ø: 7.5 cm | L: 2.4 cm

Colour rendering	90
Output	6.1 W
Energy consumption/1000 h	7 kWh

Options **Prod. no.**

- white
520 lm | 4000 K **1005269**
- white
490 lm | 3000 K **1005271**
- white
490 lm | 2700 K **1005272**

LED QR51
GU5.3

12 V
Material: glass
Ø: 5 cm | L: 4.5 cm

Colour rendering	90
Output	5.8 W
Energy consumption/1000 h	6 kWh

Options **Prod. no.**

- transparent
450 lm | 2700 K **1001574**
- transparent
460 lm | 3000 K **1001575**

LED A60
GU10

220-240 V ~50/60 Hz
Material: glass
Ø: 6 cm | L: 11 cm

Manufacturer	Segula
Luminous flux	400 lm
Colour rendering	90
Output	5 W
Energy consumption/1000 h	5 kWh

Options **Prod. no.**

- transparent
2200 K **1008154**

LED A60
GU10

220-240 V ~50/60 Hz
Material: glass
Ø: 6 cm | L: 11 cm

Manufacturer	Segula
Luminous flux	650 lm
Colour rendering	90
Output	6.5 W
Energy consumption/1000 h	7 kWh

Options **Prod. no.**

- transparent
2700 K **1008375**

LED T32 GU10



220-240 V ~50/60 Hz
Material: glass
Ø: 3.2 cm L: 10 cm

Manufacturer	Segula
Luminous flux	270 lm
Colour rendering	90
Output	3.2 W
Energy consumption/1000h	4 kWh

Options	Prod. no.
<input type="radio"/> transparent 2700 K	1006321

LED QPAR51 GU10



220-240 V ~50/60 Hz
Material: glass
Ø: 5 cm | L: 5 cm

Luminous flux	360 lm
Colour rendering	90
Output	6 W
Energy consumption/1000h	6 kWh

Options	Prod. no.
<input type="radio"/> silver 2200 K	1005273

LED QPAR51 GU10



220-240 V ~50/60 Hz
Material: plastic PC

Colour rendering	90
Output	6 W
Energy consumption/1000h	6 kWh

Options	Prod. no.
● black 450 lm 2700 K	1005077
● black 470 lm 3000 K	1005080
● black 490 lm 4000 K	1005083

LED QPAR51 GU10



220-240 V ~50/60 Hz
Material: plastic PC

Luminous flux	450 lm
Colour rendering	90
Output	6 W
Energy consumption/1000h	6 kWh

Options	Prod. no.
<input type="radio"/> white 450 lm 2700 K	1005076
<input type="radio"/> white 470 lm 3000 K	1005079
<input type="radio"/> white 490 lm 4000 K	1005082

LED QPAR51 GU10



220-240 V ~50/60 Hz
Material: plastic PC

Luminous flux	450 lm
Colour rendering	90
Output	6 W
Energy consumption/1000h	6 kWh

Options	Prod. no.
● grey 450 lm 2700 K	1005075
● grey 470 lm 3000 K	1005078
● grey 490 lm 4000 K	1005081

LED QPAR51 GU10



220-240 V ~50/60 Hz
Material: glass
Ø: 5 cm | L: 5.4 cm

Luminous flux	230 lm
Colour rendering	80
Output	2.4 W
Energy consumption/1000h	3 kWh

Options	Prod. no.
<input type="radio"/> transparent 2700 K	1007230
<input type="radio"/> transparent 3000 K	1007231



LED QPAR111 GU10



220-240 V ~50/60 Hz
Material: aluminium
Ø: 11 cm | L: 7 cm

Colour rendering	90
Output	12 W
Energy consumption/1000 h	12 kWh

Options	Prod. no.
<input checked="" type="radio"/> aluminium 670 lm 2700 K	1005297
<input checked="" type="radio"/> aluminium 680 lm 3000 K	1005298
<input checked="" type="radio"/> aluminium 750 lm 4000 K	1005299

LED QPAR111 GU10



220-240 V ~50/60 Hz
Material: aluminium
Ø: 11.1 cm | L: 7 cm

Colour rendering	90
Output	12.5 W
Energy consumption/1000 h	13 kWh

Options	Prod. no.
<input type="radio"/> silver 900 lm 2700 K 10°	1005275
<input type="radio"/> silver 650 lm 3000 K 12°	1005278
<input type="radio"/> silver 1000 lm 4000 K 10°	1005281

LED QPAR111 GU10



220-240 V ~50/60 Hz
Material: aluminium
Ø: 11.1 cm | L: 7 cm

Colour rendering	90
Output	12.5 W
Energy consumption/1000 h	13 kWh

Options	Prod. no.
<input type="radio"/> silver 950 lm 2700 K	1005276
<input type="radio"/> silver 950 lm 3000 K	1005279
<input type="radio"/> silver 1000 lm 4000 K	1005282

LED QPAR111 GU10



220-240 V ~50/60 Hz
Material: aluminium
Ø: 11.1 cm | L: 7 cm

Luminous flux	1000 lm
Colour rendering	90
Output	12.5 W
Energy consumption/1000 h	13 kWh

Options	Prod. no.
<input type="radio"/> silver 1000 lm 2700 K	1005277
<input type="radio"/> silver 1000 lm 3000 K	1005280
<input type="radio"/> silver 1100 lm 4000 K	1005283

LED QPAR111 GU10



220-240 V ~50/60 Hz
Material: glass
Ø: 11.1 cm | L: 6.1 cm

Luminous flux	680 lm
Colour rendering	90
Output	8 W
Energy consumption/1000 h	8 kWh

Options	Prod. no.
<input type="radio"/> transparent 2700 K	1005274

LED A19 E27



220-240 V ~50/60 Hz
Material: glass
Ø: 6 cm | L: 11 cm

Luminous flux	570 lm
Colour rendering	90
Output	6 W
Energy consumption/1000 h	6 kWh

Options	Prod. no.
<input type="radio"/> transparent 2200 K	1008153

LED A60 E27



220-240 V ~50/60 Hz
Material: plastic
Ø: 6 cm | L: 12 cm

Luminous flux	1300 lm
Colour rendering	90
Output	13.2 W
Energy consumption/1000h	14 kWh

Options	Prod. no.
<input type="radio"/> white 2700 K	1005302

LED A60 E27, High Efficiency



220-240 V ~50/60 Hz
Material: glass
Ø: 6 cm | L: 10.8 cm

Colour rendering	80
Output	3.8 W
Energy consumption/1000h	4 kWh

Options	Prod. no.
<input type="radio"/> transparent 830 lm 2700 K	1008641
<input type="radio"/> transparent 860 lm 3000 K	1008642

LED A60 E27



220-240 V ~50/60 Hz
Material: glass
Ø: 6 cm | L: 10.8 cm

Luminous flux	810 lm
Colour rendering	80
Output	8 W
Energy consumption/1000h	8 kWh

Options	Prod. no.
<input type="radio"/> transparent 2700 K	1008643
<input type="radio"/> transparent 3000 K	1008644

LED A60 E27



220-240 V ~50/60 Hz
Material: glass
Ø: 6 cm | L: 10.5 cm

Luminous flux	800 lm
Colour rendering	90
Output	7.5 W
Energy consumption/1000h	8 kWh

Options	Prod. no.
<input type="radio"/> transparent 2700 K	1005303

LED GLOBE 150 E27, Twisted Smokey Grey



220-240 V ~50/60 Hz
Material: glass
Ø: 15 cm | L: 18.5 cm

Manufacturer	Segula
Luminous flux	230 lm
Colour rendering	85
Output	6 W
Energy consumption/1000h	6 kWh

Options	Prod. no.
<input checked="" type="radio"/> smoky grey 1900 K	1008151

LED GLOBE 125 E27, Soft Curve Smokey



220-240 V ~50/60 Hz
Material: glass
Ø: 12.5 cm | L: 18 cm

Manufacturer	Segula
Luminous flux	400 lm
Colour rendering	90
Output	8 W
Energy consumption/1000h	8 kWh

Options	Prod. no.
<input checked="" type="radio"/> smoky grey 1900 K	1008159



LED GLOBE 125

E27, Slanting Top Smokey



220-240 V ~50/60 Hz
Material: glass
Ø: 12.5 cm | L: 18 cm

Manufacturer	Segula
Luminous flux	350 lm
Colour rendering	90
Output	5 W
Energy consumption/1000 h	5 kWh

Options	Prod. no.
---------	-----------

- | | |
|------------------------|----------------|
| ● smoky grey
2200 K | 1008160 |
|------------------------|----------------|

LED GLOBE 125

E27, Crescent Slanting Smokey



220-240 V ~50/60 Hz
Material: glass
Ø: 12.5 cm | L: 18 cm

Manufacturer	Segula
Luminous flux	310 lm
Colour rendering	90
Output	6 W
Energy consumption/1000 h	6 kWh

Options	Prod. no.
---------	-----------

- | | |
|------------------------|----------------|
| ● smoky grey
1900 K | 1008161 |
|------------------------|----------------|

LED GLOBE 125

E27, Black Smokey



220-240 V ~50/60 Hz
Material: glass
Ø: 12.5 cm | L: 16.5 cm

Manufacturer	Segula
Luminous flux	220 lm
Colour rendering	85
Output	6 W
Energy consumption/1000 h	6 kWh

Options	Prod. no.
---------	-----------

- | | |
|------------------------|----------------|
| ● smoky grey
1900 K | 1008155 |
|------------------------|----------------|

LED GLOBE 150

E27, Black Smokey



220-240 V ~50/60 Hz
Material: glass
Ø: 15 cm | L: 18.5 cm

Manufacturer	Segula
Luminous flux	260 lm
Colour rendering	85
Output	6 W
Energy consumption/1000 h	6 kWh

Options	Prod. no.
---------	-----------

- | | |
|------------------------|----------------|
| ● smoky grey
1900 K | 1008163 |
|------------------------|----------------|

LED GLOBE 200

E27, Black Smokey



220-240 V ~50/60 Hz
Material: glass
Ø: 20 cm | L: 23 cm

Manufacturer	Segula
Luminous flux	300 lm
Colour rendering	85
Output	6 W
Energy consumption/1000 h	6 kWh

Options	Prod. no.
---------	-----------

- | | |
|------------------------|----------------|
| ● smoky grey
1900 K | 1008164 |
|------------------------|----------------|

LED GLOBE 300

E27, Black Smokey



220-240 V ~50/60 Hz
Material: glass
Ø: 30 cm | L: 32 cm

Manufacturer	Segula
Luminous flux	350 lm
Colour rendering	85
Output	8 W
Energy consumption/1000 h	8 kWh

Options	Prod. no.
---------	-----------

- | | |
|------------------------|----------------|
| ● smoky grey
1900 K | 1008165 |
|------------------------|----------------|

LED T32 E27, Soft Spiral



220-240 V ~50/60 Hz
Material: glass
Ø: 3.2 cm | L: 19 cm

Manufacturer	Segula
Luminous flux	570 lm
Colour rendering	90
Output	6 W
Energy consumption/1000h	6 kWh

Options	Prod. no.
<input type="radio"/> transparent 2200 K	1008152

LED T32 E27, Soft Tube



220-240 V ~50/60 Hz
Material: glass
Ø: 3.2 cm | L: 30 cm

Manufacturer	Segula
Luminous flux	400 lm
Colour rendering	90
Output	8 W
Energy consumption/1000h	8 kWh

Options	Prod. no.
<input type="radio"/> transparent 1900 K	1008374

LED T38 E27



220-240 V ~50/60 Hz
Material: plastic
Ø: 3.8 cm | L: 11.6 cm

Luminous flux	880 lm
Colour rendering	90
Output	8 W
Energy consumption/1000h	8 kWh

Options	Prod. no.
<input type="radio"/> white 3000 K	1005289

LED T45 E27



220-240 V ~50/60 Hz
Material: plastic
Ø: 4.5 cm | L: 14 cm

Luminous flux	1520 lm
Colour rendering	90
Output	13.5 W
Energy consumption/1000h	14 kWh

Options	Prod. no.
<input type="radio"/> white 3000 K	1005307

LED T32 E27, Slim Tube



220-240 V ~50/60 Hz
Material: glass
Ø: 5.2 cm | L: 17.5 cm

Manufacturer	Segula
Luminous flux	1250 lm
Colour rendering	90
Output	11 W
Energy consumption/1000h	11 kWh

Options	Prod. no.
<input type="radio"/> transparent 2700 K	1008162

LED ST64 E27, Gold



220-240 V ~50/60 Hz
Material: glass
Ø: 6.4 cm | L: 14.5 cm

Luminous flux	700 lm
Colour rendering	90
Output	7.5 W
Energy consumption/1000h	8 kWh

Options	Prod. no.
<input checked="" type="radio"/> gold 2500 K	1005265



LED ST65

E27, Soft Cage



220-240 V ~50/60 Hz
Material: glass
Ø: 6.5 cm | L: 14.5 cm

Manufacturer	Segula
Luminous flux	570 lm
Colour rendering	90
Output	6 W
Energy consumption/1000 h	6 kWh

Options	Prod. no.
---------	-----------

- | | |
|---|----------------|
| <input type="radio"/> transparent
2200 K | 1008156 |
|---|----------------|

LED ST64

E27, Gold Curly Filament



220-240 V ~50/60 Hz
Material: glass
Ø: 6.4 cm | L: 14.2 cm

Colour rendering	80
Output	4 W
Energy consumption/1000 h	4 kWh

Options	Prod. no.
---------	-----------

- | | |
|--|----------------|
| <input checked="" type="radio"/> gold/transparent
250 lm 1800 K | 1008645 |
| <input checked="" type="radio"/> gold/transparent
300 lm 2000 K | 1008646 |

LED ST58

E27



220-240 V ~50/60 Hz
Material: glass
Ø: 5.8 cm | L: 14.2 cm

Luminous flux	800 lm
Colour rendering	90
Output	7.5 W
Energy consumption/1000 h	8 kWh

Options	Prod. no.
---------	-----------

- | | |
|---|----------------|
| <input type="radio"/> transparent
2700 K | 1005268 |
|---|----------------|

LED A60

E27, Mirrorhead Chrom



220-240 V ~50/60 Hz
Material: glass
Ø: 6 cm | L: 10.5 cm

Luminous flux	720 lm
Colour rendering	90
Output	7.5 W
Energy consumption/1000 h	8 kWh

Options	Prod. no.
---------	-----------

- | | |
|---|----------------|
| <input checked="" type="radio"/> chrome
2700 K | 1005305 |
|---|----------------|

LED GLOBE 125

E27



220-240 V ~50/60 Hz
Material: glass
Ø: 12.5 cm | L: 17.8 cm

Luminous flux	800 lm
Colour rendering	90
Output	7.5 W
Energy consumption/1000 h	8 kWh

Options	Prod. no.
---------	-----------

- | | |
|---|----------------|
| <input type="radio"/> transparent
2700 K | 1005310 |
|---|----------------|

LED GLOBE 125

E27, Half Moon



220-240 V ~50/60 Hz
Material: glass
Ø: 12.5 cm | L: 18 cm

Manufacturer	Segula
Luminous flux	650 lm
Colour rendering	90
Output	6.5 W
Energy consumption/1000 h	7 kWh

Options	Prod. no.
---------	-----------

- | | |
|---|----------------|
| <input type="radio"/> frosted
2700 K | 1008157 |
|---|----------------|

SLVconnect®
LED A60 Smart
E27, Tunable White



220-240 V ~50/60 Hz
Material: aluminium/plastic/PC
Ø: 6 cm

Luminous flux	1100 lm
Colour rendering	90
Output	8.5 W
Energy consumption/1000h	9 kWh



220-240 V ~50/60 Hz
Material: aluminium/plastic/PC
Ø: 6 cm

Luminous flux	1100 lm
Colour rendering	90
Output	9.5 W
Energy consumption/1000h	10 kWh



220-240 V ~50/60 Hz
Material: aluminium
Ø: 11.1 cm

Luminous flux	750 lm
Colour rendering	90
Output	10 W
Energy consumption/1000h	10 kWh

Options	Prod. no.
<input type="radio"/> white 2200-6500 K	1010465 ●

Options	Prod. no.
<input type="radio"/> white 1800-6500 K	1010466 ●

Options	Prod. no.
<input type="radio"/> white 2200-6500 K	1010467 ●

SLVconnect®
LED ST19 Smart
E27, Tunable White



220-240 V ~50/60 Hz
Material: glass
Ø: 6 cm

Luminous flux	640 lm
Colour rendering	90
Output	7 W
Energy consumption/1000h	7 kWh



220-240 V ~50/60 Hz
Material: glass
Ø: 6 cm

Luminous flux	640 lm
Colour rendering	90
Output	7 W
Energy consumption/1000h	7 kWh



220-240 V ~50/60 Hz
Material: aluminium/PC
Ø: 5 cm

Luminous flux	420 lm
Colour rendering	90
Output	5 W
Energy consumption/1000h	5 kWh

Options	Prod. no.
<input checked="" type="radio"/> amber 2200-4000 K	1010484 ●

Options	Prod. no.
<input checked="" type="radio"/> amber 2200-4000 K	1010486 ●

Options	Prod. no.
<input type="radio"/> white 2200-6500 K	1010470 ●



SLVconnect®
LED QPAR51 Smart
GU10, RGBW



NEW



220-240 V ~50/60 Hz
Material: aluminium/PC
Ø: 5 cm

Luminous flux	400 lm
Colour rendering	90
Output	5 W
Energy consumption/1000 h	5 kWh

Options	Prod. no.
<input type="radio"/> white 2200-6500 K	1010471 ●

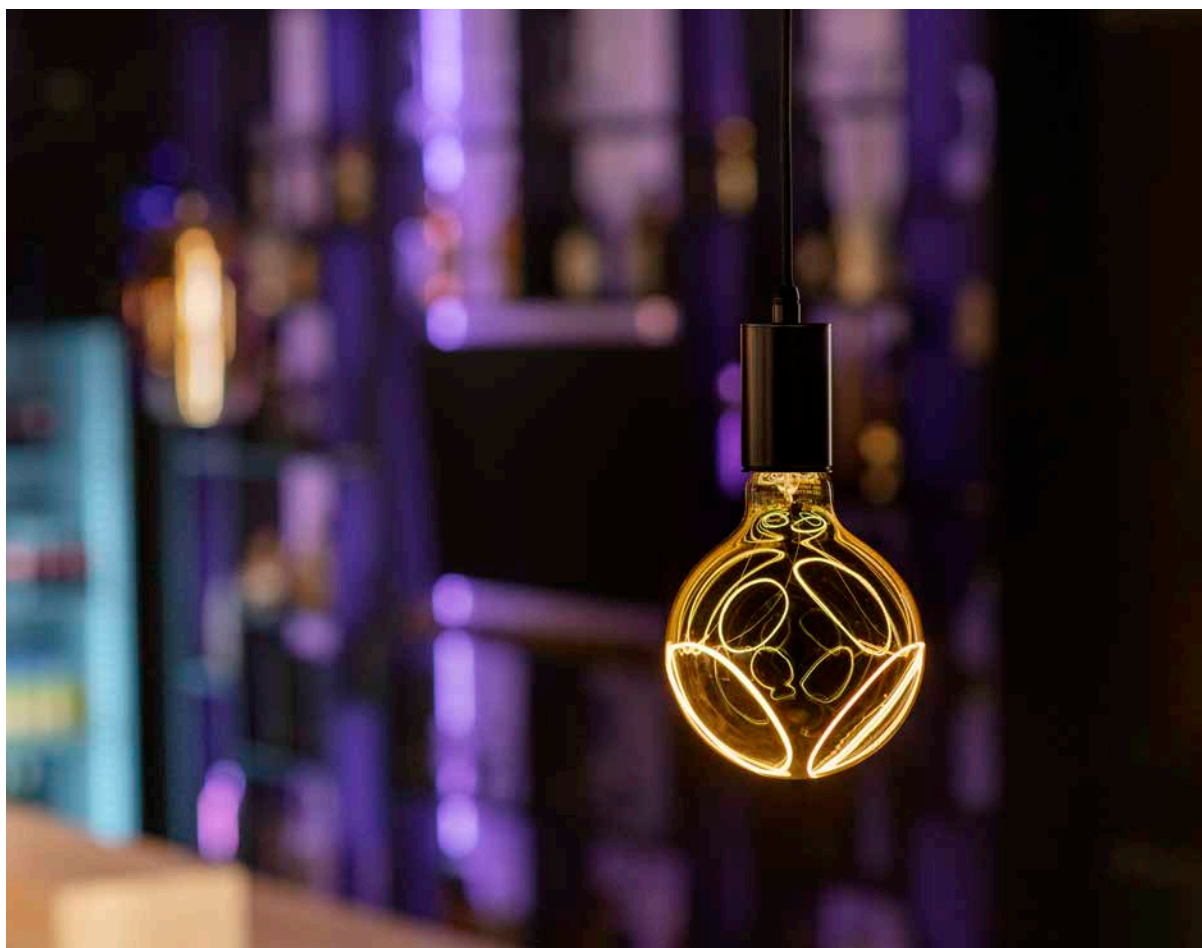





E-TRANS-
FORMATOR | 328



TRANSFORMATOR
TENSEO | 328



DALI
INTERFACE | 328



KONVERTER | 328



LED NETZTEIL |
329-313



LED NETZTEIL
DIMMBAR | 329



LED TREIBER |
329-335



CONTROLLER | 336



NOTLICHT-
ELEMENT | 336



DECKENHAKEN | 337



KABELKLEMME | 337



DECKENROSETTE |
337



TEXTILKABEL | 337



GU10 LED CONNEC-
TION BOX | 337



KABEL | 337



GU10
FASSUNG | 338



VERBINDUNGS-
BOX | 338



VERBINDUNGS-
BOX Y | 338



FERNBEDIENUNG |
338

E-TRANSFORMER

60W | 12V dimmable



220-240 V ~50/60 Hz
L: 10.6 cm | W: 3.3 cm | H: 2.2 cm

Output voltage	11.2V-11.5V
Output from	3 W
Output up to	60 W
Thermal protection	110°C
Number of sec. outputs	1

Options	Prod. no.
<input type="radio"/> white	1008675

TENSEO TRANSFORMER

12V AC | 50VA conventional



220-240 V ~50/60 Hz
Ø: 11.1 cm | H: 11 cm
Material: steel/brass

Output voltage	12V AC
Output up to	60 W
Thermal protection	130°C
Number of sec. outputs	1

Options	Prod. no.
<input checked="" type="radio"/> black	1002691
<input type="radio"/> white	1002692
<input type="radio"/> chrome	1002693

TENSEO TRANSFORMER

12V AC | 105VA conventional



220-240 V ~50/60 Hz
Ø: 11.1 cm | H: 11 cm
Material: steel/brass

Output voltage	12V AC
Output up to	105 W
Thermal protection	110°C
Number of sec. outputs	1

Options	Prod. no.
<input type="radio"/> white	138981
<input checked="" type="radio"/> chrome	138982

TENSEO TRANSFORMER

12V AC | 210VA conventional



220-240 V ~50/60 Hz
Ø: 13.5 cm | H: 11 cm
Material: steel/brass

Output voltage	12V AC
Output up to	210 W
Thermal protection	130°C
Number of sec. outputs	1

Options	Prod. no.
<input type="radio"/> white	138991
<input checked="" type="radio"/> chrome	138992

DALI INTERFACE

1-10V + on/off



L: 5.9 cm | W: 3.25 cm | H: 1.5 cm
Material: plastic

- Suitable for controlling electronic ballasts with 1-10V control input
- Galvanic isolation of DALI input and 1-10V output

max. nominal load	1000 W
-------------------	--------

Options	Prod. no.
<input checked="" type="radio"/> grey	1002218

CONVERTER

Phase dim -> Dali



L: 4.6 cm | W: 4.5 cm | H: 2 cm
Material: polycarbonate (PC)

Output voltage	100-240V
max. nominal load	200 W

Options	Prod. no.
<input type="radio"/> white	1006452



LED POWER SUPPLY

24V | 24W



220-240 V ~50/60 Hz
L: 13.7 cm | W: 5 cm | H: 1.55 cm

- Extra-flat design
- Strain relief included

Output voltage	24 V DC
Output up to	30 W
Number of sec. outputs	1

Options	Prod. no.
<input type="radio"/> white	1008653

LED POWER SUPPLY

24V | 36W



220-240 V ~50/60 Hz
L: 17 cm | W: 5.7 cm | H: 1.8 cm

- Extra-flat design
- Strain relief included

Output voltage	24V
Output up to	36 W
Number of sec. outputs	1

Options	Prod. no.
<input type="radio"/> white	1008654

LED POWER SUPPLY

24V | 60W



220-240 V ~50/60 Hz
L: 17 cm | W: 5.7 cm | H: 1.8 cm

- Extra-flat design
- Strain relief included

Output voltage	24V
Output up to	60 W
Thermal protection	110°C
Number of sec. outputs	1

Options	Prod. no.
<input type="radio"/> white	1008655

LED POWER SUPPLY

12V | 24W, round



220-240 V ~50/60 Hz
Ø: 5.5 cm | H: 2.5 cm

- Suitable for box installation
- Strain relief not included

Output voltage	12 V
Output from	1.2 W
Output up to	24 W
Thermal protection	110°C
Number of sec. outputs	1

Options	Prod. no.
<input type="radio"/> white	1008651

LED POWER SUPPLY 24

24V | 25W, round



220-240 V ~50/60 Hz
Ø: 5.5 cm | H: 2.5 cm

- Suitable for box installation
- Strain relief not included

Output voltage	24V
Output from	1.2 W
Output up to	25 W
Number of sec. outputs	1

Options	Prod. no.
<input type="radio"/> white	1008652

LED POWER SUPPLY

30W | 24V DC Strain relief included



220-240 V ~50/60 Hz
L: 30 cm | W: 3 cm | H: 1.6 cm
Material: polycarbonate (PC)

- Suitable for box installation
- Strain relief not included

Output voltage	24V
Output from	0 W
Output up to	30 W
Control gear power factor	0.95
Thermal protection	110°C
Number of sec. outputs	1

Options	Prod. no.
<input type="radio"/> white	1007250

LED POWER SUPPLY
100W | 24V DC Strain relief included



220-240 V ~50/60 Hz
L: 35 cm | W: 3 cm | H: 1.8 cm
Material: polycarbonate (PC)

Output voltage	24V
Output from	0 W
Output up to	100W
Control gear power factor	0.95
Thermal protection	110°C
Number of sec. outputs	1

Options	Prod. no.
<input type="radio"/> white	1007251

LED POWER SUPPLY
150W | 24V DC Strain relief included



220-240 V ~50/60 Hz
L: 35 cm | W: 3 cm | H: 1.8 cm
Material: polycarbonate (PC)

Output voltage	24V
Output from	0 W
Output up to	150 W
Control gear power factor	0.95
Thermal protection	110°C
Number of sec. outputs	1

Options	Prod. no.
<input type="radio"/> white	1007252

LED POWER SUPPLY
250W | 24V DC Strain relief included



220-240 V ~50/60 Hz
L: 40 cm | W: 4 cm | H: 2.2 cm
Material: polycarbonate (PC)

Output voltage	24V
Output from	0 W
Output up to	250 W
Control gear power factor	0.95
Thermal protection	110°C
Number of sec. outputs	1

Options	Prod. no.
<input type="radio"/> white	1007253

LED POWER SUPPLY
25W | 24V



220-240 V ~50/60 Hz
L: 12.8 cm | W: 5.2 cm | H: 3 cm
Material: polycarbonate (PC)

Output voltage	24V
Output from	9.6 W
Output up to	25 W
Control gear power factor	0.95
Thermal protection	110°C
Number of sec. outputs	1

Options	Prod. no.
<input type="radio"/> white/grey	1006336

POWER ADAPTER
50W | 24V



220-240 V ~50/60 Hz
L: 18.4 cm | W: 6.1 cm | H: 3.2 cm
Material: polycarbonate (PC)

Output voltage	24V
Output from	12 W
Output up to	50 W
Control gear power factor	0.95
Thermal protection	110°C
Number of sec. outputs	1

Options	Prod. no.
<input type="radio"/> white/blue	1003104

POWER ADAPTER
100W | 24V DC



220-240 V ~50/60 Hz
L: 21 cm | W: 6.7 cm | H: 3.4 cm
Material: polycarbonate (PC)

Output voltage	24V
Output from	33 W
Output up to	100 W
Control gear power factor	0.95
Thermal protection	110°C
Number of sec. outputs	1

Options	Prod. no.
<input type="radio"/> white/blue	1003105



LED POWER SUPPLY

30W | 24V DC Dali dimmable
including strain relief



220-240 V ~50/60 Hz
L: 30 cm | W: 3 cm | H: 1.6 cm
Material: polycarbonate (PC)

Output voltage	24V
Output from	12 W
Output up to	30 W
Control gear power factor	0.95
Thermal protection	110°C
Number of sec. outputs	1

Options	Prod. no.
---------	-----------

<input type="radio"/> white	1007254
-----------------------------	----------------

LED POWER SUPPLY

100W | 24V DC Dali dimmable
including strain relief



220-240 V ~50/60 Hz
L: 35 cm | W: 3 cm | H: 1.8 cm
Material: polycarbonate (PC)

Output voltage	24V
Output from	30 W
Output up to	100 W
Control gear power factor	0.95
Thermal protection	110°C
Number of sec. outputs	1

Options	Prod. no.
---------	-----------

<input type="radio"/> white	1007255
-----------------------------	----------------

LED POWER SUPPLY

150W | 24V DC Dali dimmable
including strain relief



220-240 V ~50/60 Hz
L: 35 cm | W: 3 cm | H: 1.8 cm
Material: polycarbonate (PC)

Output voltage	24V
Output from	45 W
Output up to	150 W
Control gear power factor	0.95
Thermal protection	110°C
Number of sec. outputs	1

Options	Prod. no.
---------	-----------

<input type="radio"/> white	1007256
-----------------------------	----------------

LED POWER SUPPLY

250W | 24V DC Dali dimmable
including strain relief



220-240 V ~50/60 Hz
L: 40 cm | W: 4 cm | H: 2.2 cm
Material: polycarbonate (PC)

Output voltage	24V
Output from	75 W
Output up to	250 W
Control gear power factor	0.95
Thermal protection	110°C
Number of sec. outputs	1

Options	Prod. no.
---------	-----------

<input type="radio"/> white	1007257
-----------------------------	----------------

LED DRIVER

4W | 350mA



220-240 V ~ 50/60Hz
L: 4.75 cm | W: 2.72 cm | H: 2 cm
Material: plastic PC

- Output current constant 350mA

Output voltage	2.7-9.5 V
Output from	1 W
Output up to	3.32 W
Number of sec. outputs	1

Options	Prod. no.
---------	-----------

<input type="radio"/> white	1008656
-----------------------------	----------------

LED DRIVER

4W | 700mA



220-240 V ~ 50/60Hz
L: 4.75 cm | W: 2.72 cm | H: 2 cm
Material: plastic PC

- Output current constant 700mA

Output voltage	2.7-4.5 V
Output from	1.9 W
Output up to	3.15 W
Thermal protection	110°C
Number of sec. outputs	1

Options	Prod. no.
---------	-----------

<input type="radio"/> white	1008657
-----------------------------	----------------

LED DRIVER 10W | 350mA round



220-240V ~ 50/60Hz
L: 202 cm | Ø: 4.23 cm
Material: plastic PC

- Output current constant 700mA

Output voltage	19-28 V
Output from	6.5 W
Output up to	15 W
Number of sec. outputs	1

Options	Prod. no.
<input type="radio"/> white	1008658

LED DRIVER 15W | 700mA round



220-240V ~ 50/60Hz
L: 2.1 cm | Ø: 5 cm
Material: plastic PC

- Output current constant 700mA

Output voltage	13-21 V
Output from	9.1 W
Output up to	14.7 W
Thermal protection	110°C
Number of sec. outputs	1

Options	Prod. no.
<input type="radio"/> white	1008659

LED DRIVER 20 W | 350mA



220-240 V ~50/60 Hz
L: 11.6 cm | W: 4.1 cm | H: 2.5 cm
Material: polycarbonate (PC)

- Output current adjustable 350mA

Output voltage	2-54 V
Output from	0.7 W
Output up to	19 W
Control gear power factor	0.95
Thermal protection	110°C
Number of sec. outputs	1

Options	Prod. no.
<input type="radio"/> white	1007225

LED DRIVER 21W | 150-500mA



220-240 V ~50/60 Hz
L: 9.8 cm | W: 4.4 cm | H: 2.3 cm
Material: plastic PC

- Output current adjustable 150-500mA

Output voltage	15-45 V
Output from	2.3 W
Output up to	22.5 W
Control gear power factor	0.95
Thermal protection	110°C
Number of sec. outputs	1

Options	Prod. no.
<input type="radio"/> white	1008699 ●

LED DRIVER 21W | 500mA Strain relief included



220-240 V ~50/60 Hz
L: 11.6 cm | W: 4.1 cm | H: 2.5 cm
Material: polycarbonate (PC)

- Output current adjustable 5000mA

Output voltage	2-4 V
Output from	1 W
Output up to	21 W
Control gear power factor	0.95
Thermal protection	110°C
Number of sec. outputs	1

Options	Prod. no.
<input type="radio"/> white	1007226

LED DRIVER 20W | 350mA | PHASE



220-240 V ~50/60 Hz
L: 11.6 cm | W: 4.1 cm | H: 2.5 cm
Material: polycarbonate (PC)

- Output current constant 350mA

Output voltage	28-50 V
Output from	9.8 W
Output up to	17.5 W
Control gear power factor	0.95
Thermal protection	110°C
Number of sec. outputs	1

Options	Prod. no.
<input type="radio"/> white	1007228



LED DRIVER

20W | 350mA/500mA | PHASE



220-240 V ~50/60 Hz
L: 11.6 cm | W: 4.1 cm | H: 2.5 cm
Material: polycarbonate (PC)

- Output current adjustable 350/500mA

Output voltage	10-30 V
Output from	3.5 W
Output up to	15 W
Control gear power factor	0.95
Thermal protection	110°C
Number of sec. outputs	1

Options	Prod. no.
<input type="radio"/> white	1007227

LED DRIVER

10W | 180-270mA PHASE



220-240 V ~50/60 Hz
L: 12.2 cm | W: 4.1 cm | H: 2.3 cm
Material: plastic (PC)

- Output current adjustable 180-270mA

Output voltage	26-38 V
Output from	4.68 W
Output up to	10 W
Thermal protection	110°C
Number of sec. outputs	1

Options	Prod. no.
<input type="radio"/> white	1008660

LED DRIVER

10W | 500-700mA PHASE



220-240 V ~50/60 Hz
L: 12.2 cm | W: 4.1 cm | H: 2.3 cm
Material: plastic (PC)

- Output current adjustable 500-700mA

Output voltage	8-14 V
Output from	4 W
Output up to	9.8 W
Thermal protection	110°C
Number of sec. outputs	1

Options	Prod. no.
<input type="radio"/> white	1008661

LED DRIVER

15W | 200-350mA PHASE



220-240 V ~50/60 Hz
L: 12.2 cm | W: 4.1 cm | H: 2.3 cm
Material: plastic (PC)

- Output current adjustable 200-350mA

Output voltage	12-42 V
Output from	5.2 W
Output up to	14.7 W
Number of sec. outputs	1

Options	Prod. no.
<input type="radio"/> white	1008662

LED DRIVER

20W | 350-500mA PHASE



220-240 V ~50/60 Hz
L: 13.76 cm | W: 4.4 cm | H: 3 cm
Material: plastic (PC)

- Output current adjustable 300-500mA

Output voltage	26-38 V
Output from	9.1 W
Output up to	19 W
Thermal protection	110°C
Number of sec. outputs	1

Options	Prod. no.
<input type="radio"/> white	1008663

LED DRIVER

30W | 500-700mA PHASE



220-240 V ~50/60 Hz
L: 13.76 cm | W: 4.4 cm | H: 3 cm
Material: plastic (PC)

- Output current adjustable 500-700mA

Output voltage	26-42 V
Output from	13 W
Output up to	30 W
Thermal protection	110°C
Number of sec. outputs	1

Options	Prod. no.
<input type="radio"/> white	1008664

LED DRIVER

40W | 700-1050mA PHASE



220-240 V ~50/60 Hz
L: 17.23 cm | W: 4.4 cm | H: 3 cm
Material: plastic (PC)

- Output current adjustable 750-1050 mA

Output voltage	27-38 V
Output from	26.6 W
Output up to	39.9 W
Thermal protection	110°C
Number of sec. outputs	1

Options	Prod. no.
<input type="radio"/> white	1008665

LED DRIVER

25W | 150-700mA | DALI dimmable



220-240 V ~50/60 Hz
L: 11.9 cm | W: 5.2 cm | H: 2.25 cm
Material: polycarbonate (PC)

- Output current adjustable 150-700 mA

Output voltage	2-42 V
Output from	0.3 W
Output up to	25 W
Thermal protection	110°C
Number of sec. outputs	1

Options	Prod. no.
<input type="radio"/> white	1007229

LED DRIVER

15W | 100-700mA DALI



220-240 V ~50/60 Hz
L: 10.35 cm | W: 3 cm | H: 2.1 cm
Material: plastic (PC)

- Output current adjustable 100-700 mA

Output voltage	2.5-46 V
Output from	0.25 W
Output up to	14.7 W
Thermal protection	110°C
Number of sec. outputs	1

Options	Prod. no.
<input type="radio"/> white	1008666

LED DRIVER

23W | 100-700mA DALI



220-240 V ~50/60 Hz
L: 10.34 cm | W: 3 cm | H: 2.1 cm
Material: plastic (PC)

- Output current adjustable 100-700 mA

Output voltage	2.5-46 V
Output from	0.25 W
Output up to	23.1 W
Thermal protection	110°C
Number of sec. outputs	1

Options	Prod. no.
<input type="radio"/> white	1008667

LED DRIVER

36W | 100-900mA DALI



220-240 V ~50/60 Hz
L: 12.8 cm | W: 4.4 cm | H: 3 cm
Material: plastic (PC)

- Output current adjustable 100-900 mA

Output voltage	2.5-50 V
Output from	0.37 W
Output up to	36 W
Thermal protection	110°C
Number of sec. outputs	1

Options	Prod. no.
<input type="radio"/> white	1008668

LED DRIVER

53W | 650-1400mA DALI



220-240 V ~50/60 Hz
Material: plastic PC

- Output current adjustable 650-1400 mA

Output voltage	2.5-44 V
Output from	1.62 W
Output up to	53.2 W
Thermal protection	110°C
Number of sec. outputs	1

Options	Prod. no.
<input type="radio"/> white	1008669

LED DRIVER

Strain relief standard



L: 3.4 cm | W: 3 cm | H: 2.1 cm
Material: plastic PC

- For DALI dimmable drivers: 1008666, 1008667, 1008668

Options	Prod. no.
<input type="radio"/> white	1008672

LED DRIVER

Strain relief standard



L: 3.8 cm | W: 3.5 cm | H: 3 cm
Material: plastic PC

- For DALI dimmable drivers: 1008669

Options	Prod. no.
<input type="radio"/> white	1008674

LED DRIVER

Strain relief through-wirable



L: 9.8 cm | W: 5.8 cm | H: 2.3 cm
Material: plastic PC

- For DALI dimmable drivers: 1008666, 1008667, 1008668

Options	Prod. no.
<input type="radio"/> white	1008673

LED DRIVER

Strain relief standard



L: 3.4 cm | W: 3.6 cm | H: 2.3 cm
Material: plastic PC

- For DALI dimmable drivers: 1008666, 1008667, 1008668

Options	Prod. no.
<input type="radio"/> white	1008670 ●

LED DRIVER

Strain relief through-wirable



L: 10.6 cm | W: 5.6 cm | H: 2.1 cm
Material: plastic PC

- For DALI dimmable drivers: 1008666, 1008667, 1008668

Options	Prod. no.
<input type="radio"/> white	1008671 ●



CONTROLLER

DALI, DT8, 5 CHANNEL



12-36 V
L: 17 cm | W: 5.34 cm | H: 2.8 cm
Material: polycarbonate (PC)

Output voltage	12-36 V
Output from	60 W
Output up to	180 W
Number of sec. outputs	5

Options	Prod. no.
<input type="radio"/> white	1007997

EMERGENCY LIGHT

FEATURE

DALI 2



Material: polycarbonate (PC)

Options	Prod. no.
<input type="radio"/> white	1007892



FITU

Ceiling hook



Ø: 1.8 cm | L: 4.6 cm
Material: aluminium

FITU

Cable clamp



Ø: 1.4 cm | L: 3.1 cm
Material: aluminium

GLENOS®

Ceiling rosette



L: 8.5 cm | W: 8.5 cm | H: 2.7 cm
Material: aluminium

Max. current load

8.5 A

Options	Prod. no.
● black	132670
○ white	132671

Options	Prod. no.
● black	132680
○ white	132681

Options	Prod. no.
● black	210060
○ white	210061

TEXTILE CABLE

10m



Ø: 0.6 cm | L: 1000 cm
Material: polyvinyl chloride (PVC)/textile

Max. voltage

300 V

Options	Prod. no.
● black	961270

GU10 LED CONNECTION BOX

with base, max. 10W

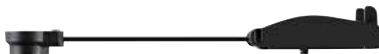

220-240V ~50/60 Hz
L: 3.8 cm | W: 3.1 cm | H: 1.7 cm
Material: plastic

Options	Prod. no.
● black	1007283

CABLE

3-pin, 3 x 0,75 mmA², 10 m



L: 1000 cm

Max. voltage

300 V

Options	Prod. no.
● black	961250

GU10 fitting



220-240 V ~50/60 Hz
 Ø: 2.8 cm | H: 1.6 cm
 Material: ceramic

CONNECTION BOX

IP68, 3-pin



220-240V ~50/60 Hz
 Ø: 2.7 cm | L: 11.5 cm
 Material: polyamide (PA)

Max. voltage	450 V
Max. current load	17.5 A

CONNECTION BOX Y

IP68, 3-pin



220-240V ~50/60 Hz
 L: 11 cm | W: 6.4 cm | H: 3 cm
 Material: polyamide (PA)

Max. voltage	450 V
Max. current load	17.5 A

Options

Prod. no.

white

955135

Options

Prod. no.

black

228730

Options

Prod. no.

black

228726

CONNECTION BOX

IP68, 5-pin



220-240V ~50/60 Hz
 Ø: 3.2 cm | L: 13 cm
 Material: polyamide (PA)

Max. voltage	450 V
Max. current load	32 A

Options

Prod. no.

black

228725

CONNECTION BOX Y

5 poles, DALI



220-240V ~50/60 Hz
 L: 18 cm | W: 6.3 cm | H: 3.3 cm
 Material: polyamide 66 (PA)

Max. voltage	450 V
Max. current load	32 A

Options

Prod. no.

black

1006453

REMOTE CONTROL

Zigbee, CCT/RGBW



L: 14 cm | w: 4.4 cm | H: 1.7 cm
 Material: polycarbonate (PC)

• Battery operation

Options

Prod. no.

white

1007827

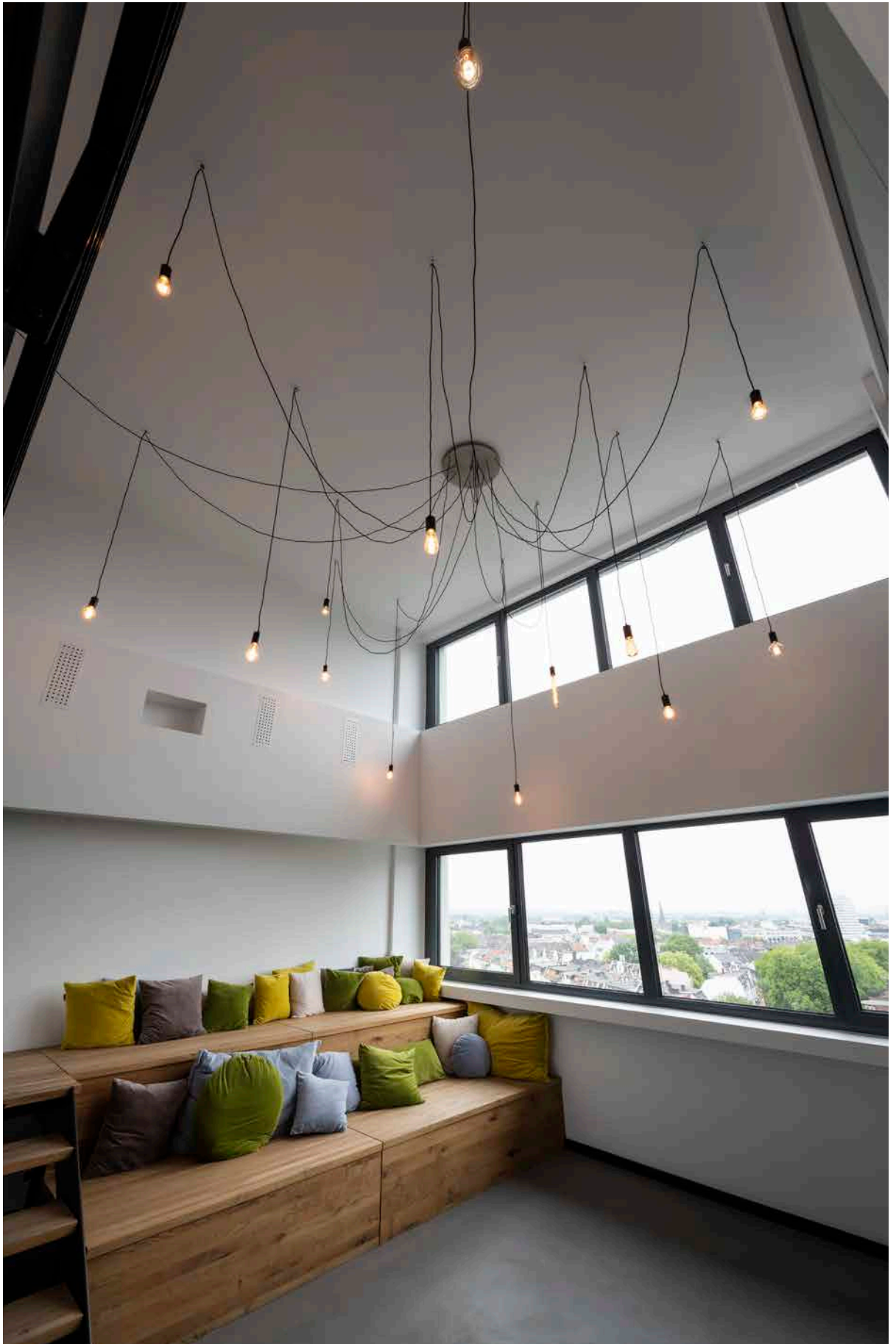

SYMBOLS KEY



Recommendations

Displays accessories and recommended bulbs for the chosen product

MIX
match

Mix & Match

Indicates products that can be combined



Energy efficiency class

"This light is suitable for bulbs with an energy efficiency rating of..."



Protection classes

- Protection class I/Protective conductor
- Protection class II/Protection by double or reinforced insulation
- Protection class III/Protection by extra-low voltage

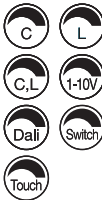

Dimmable with:

- C = Trailing-edge phase dimmer
- L = Leading-edge phase dimmer
- Uni = Universal dimmer
- 1-10 V
- Dali = DALI bus system
- Switch = Switch/button or touch control on the light
- **Touch** = Simple, stepless operation; responds to touch



IP protection rating:

Indicates the suitability of electrical equipment for different environmental conditions.



Impact resistance rating:

The impact resistance rating is a measure of the resistance of housings for electrical equipment to mechanical stress, especially impact stress.



Half-diffusion angle:

Describes the beam angle in degrees. The smaller the angle, the more concentrated the light will be.

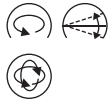

Rotation and pivoting capacity in degrees:

- Rotation range
- Pivot range
- Gimballed



Preservation of luminous flux:

Describes the amount by which the luminous flux of an LED decreases during a specified period.



Unified Glare Rating:

The lower the UGR value, the lower the psychological glare.



Pendant cable length

in cm

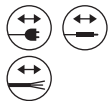

Cable length:

Mains plugs, connectors and supply cables (with open cable end) in cm



Through-wiring possible

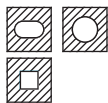

Shape of the installation opening



Specification of the installation depth



Drive-over capability of the product ensured



Weight-bearing capacity of the product up to the specified value

in tonnes. Measurements based on concrete installation.



Sea-air resistant coating



Independent converter:

Control equipment also for use outside of lights



Short-circuit protected safety control equipment



Connected lighting:

- Indicates smart products that use the following protocols:
- Zigbee®
- DALI
- Bluetooth



Allows the installation of electrical control equipment on materials whose flammability is not known.



CCT switch:

By means of an integrated CCT switch, the light colour can be changed from 2700 K, 3000 K, 4000 K to 6500 K during installation.



Dim-to-warm:

With dimmers, the light colour can be altered from cold white to warm white.



Indicates lights with RGB+W and RGB

(Red-Green-Blue + White and Red-Green-Blue)



Indicates lights with motion sensors

(Microwaves (MR) - Technology / Infrared / Radio)



- Products with integrated LEDs



- Products with light socket



- Identifies smart accessories and light sources that are compatible® with SLVconnect

KS Profishop for SLV Leuchten



Link to the KS Profishop for SLV lights at www.profishop.online

The business advantages offered by the SLV Profishop make your daily work easier.

Visit our SLV Profishop at www.profishop.online and benefit from the following advantages and features:

- Current special offers and new products
- Online availability check
- Find and order all SLV spare parts with ease
- Quick order form for fast order entry
- All SLV catalogues available for download or as online flip-through catalogues with product links
- Tender texts, light distribution curves/LDT plug-ins and quick calculation tables
- Easy product search with detailed filter functions
- Configurators for lighting systems
- Display of your individual purchasing conditions, delivery and payment terms
- Dropshipping delivery directly to your customers (delivery addresses can be entered online)
- Suitable product recommendations for light sources, accessories, drivers, ECGs, etc.
- Display of alternative products and product families/variants
- Online chat with our advisors for your questions
- Online archive of your previous online orders
- Remaining stock offers at rock-bottom prices

Confidential customer information:

Your order in the SLV Profishop will be processed by KS Licht- u. Elektrotechnik GmbH.
All prices are subject to statutory value added tax, currently 19%.

The sales prices listed are recommended retail prices. The euro prices serve as a calculation aid for specialist retailers.
With the publication of this price list, the prices in all previously published price lists are no longer valid.

Our luminaire prices do not include light bulbs unless the product description indicates that the delivery includes light bulbs. Equipment specifications (lamp power) refer to maximum values.

The illustrations and information contained in this catalogue are for illustrative purposes only and are not binding in terms of colour, shape, design and technical data.

Shipping is generally carriage forward ex works.

Custom-made products of any kind, components from our product range assembled at the customer's request and lamps are excluded from exchange. For orders under £70.00, a minimum quantity surcharge of £8.00 will be added.

When ordering, please always specify the item number, colour and quantity. This will save queries and errors.

For urgent orders, we offer the following delivery options, provided the goods are available in stock and the order is received by 12 noon:

- Overnight delivery by 10:30 a.m. or 12:00 p.m. in Germany via express shipping
- Same-day delivery via direct transport to the destination

We will be happy to provide you with information about the costs in each individual case.

Opening hours:

Monday - Thursday continuously from 8 a.m. to 4.30 p.m.
Friday continuously from 8 a.m. to 3 p.m.

During these hours, you can reach our **sales team** at +49 (0) 201-899 24-0.
For fax orders, please use the **fax number** +49 (0) 201-899 24 124.
You can reach us by **email** at Online-Shop@KS-Germany.com.

We will be happy to provide you with our terms and conditions upon request. You can also find them on the back of our letter and online at www.profishop.online/allgemeine-geschaeftsbedingungen. We do not recognise any conflicting terms and conditions of purchase.

KS Licht- u. Elektrotechnik GmbH, Manderscheidtstr. 8c, 45141 Essen



Profishop für **SLV** Leuchten

powered by

KS Licht- u. Elektrotechnik GmbH
Manderscheidstr. 8c
45141 Essen

Tel.: +49 (0)201-89924-0
Fax: +49 (0)201-89924-124

Onlineshop: www.profishop.online
Internet: www.KS-Germany.com
Email: Online-Shop@KS-Germany.com

Visit us on site or give us a call:

Monday - Thursday from 08.00 Uhr until 16.30 Uhr
Friday from 08.00 Uhr until 15.00 Uhr

SOCIAL MEDIA

Stay in touch with us and up to date. Don't miss out on any news or trends. On Facebook, YouTube, Instagram, Pinterest, X, Xing and LinkedIn you will find interesting facts, news and lots of inspiration on how you can expand your business with the KS Licht brand world.

Follow us now!

